

NOVVES

Smoke Control Systems
Comfort Ventilation

Product Catalogue

www.novves.com

More liveable air is possible for all environments with efficient and qualified solutions.

WHO WE ARE, WHERE WE ARE,

NOVVES, which is an expert in the field of fan, which is a turbo machine, was founded in 2013 by Erdal ÖZÜNTÜRK and Zeki Kadir ÖZÜNTÜRK. It produces aerodynamic, highly efficient and robust products designed with fluid mechanics knowledge in its integrated facility in Yalova, which has a closed area of 3000 m².

NOVVES provides services in the fields of production, R&D, sales, marketing, project design, testing and commissioning in the field of fire safety and comfort ventilation.

It provides services to more than 22 countries by carrying out sales, after-sales and marketing activities in its head office in Istanbul with its experienced and innovative team.

Novves aims to meet indoor air quality needs in a timely and high quality manner with optimum solutions.

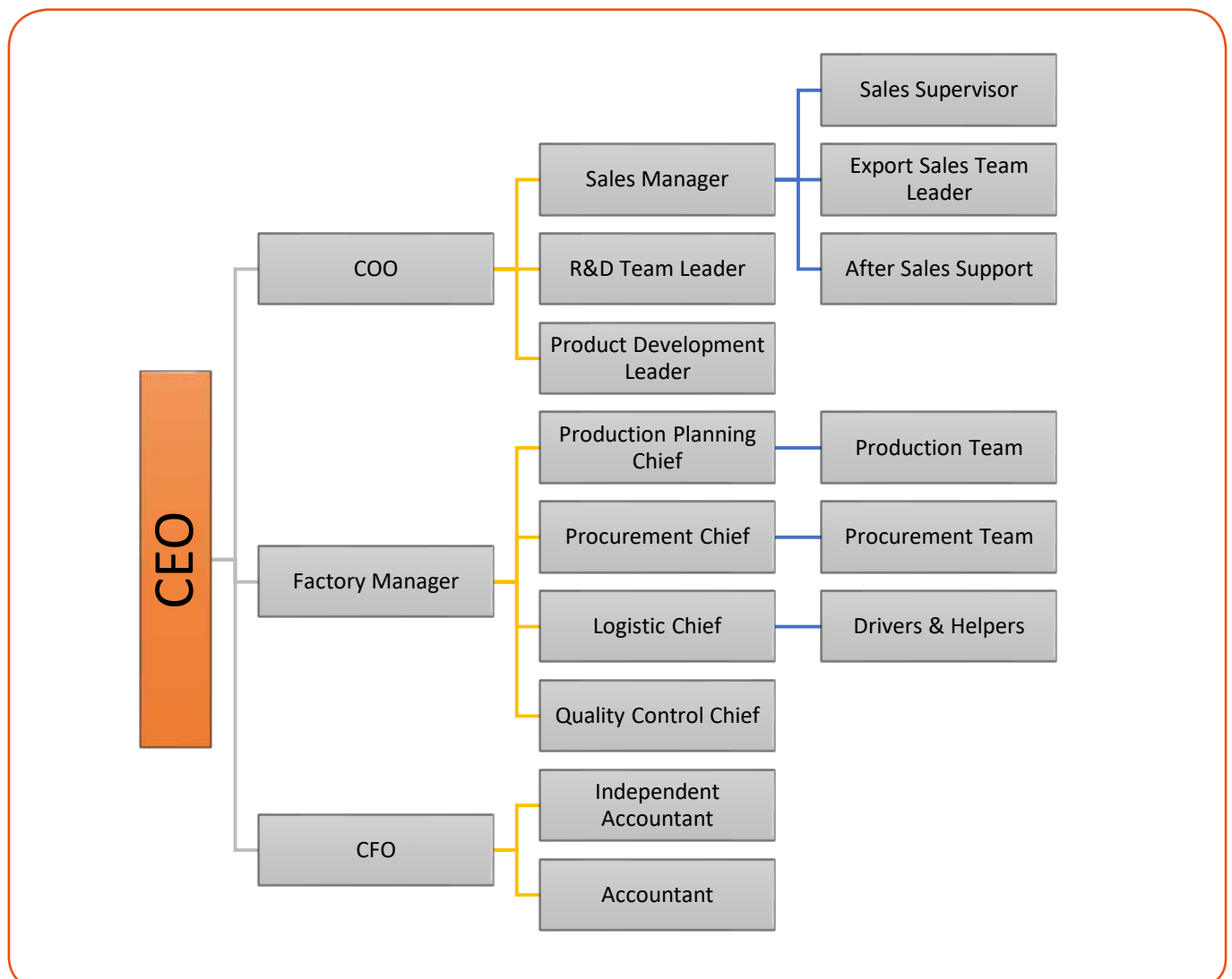

OUR PHILOSOPHY

Our philosophy is to take a step forward with an engineering approach that respects nature and people within the framework of international standards, and to leave a reference point strengthened with an engineering understanding that has ethical values in every subject. To create and maintain a structure that respects customers, employees, nature and the competitive environment, works with a correct and honest engineering approach within the scope of international standards.

OUR GOAL

To establish innovative systems that will move the air in the most accurate and efficient way for human health and comfort with its engineering knowledge and experience and to be one of the first companies that come to mind with robust quality-performance products in its field. Feasible, durable, innovative.



APPLICATION AREAS

We operate in car parks, shopping malls, residences, hospitals, hotels, highway tunnels, subway tunnels, industrial facilities and similar structures, in short, wherever people can breathe!



Comfort Ventilation

Considering that a large part of human life is spent in closed environments, it is extremely important to provide comfort conditions in these environments in order to have a healthy life. In the simplest terms, as NOVVES, we offer solutions with our wide range of products for comfortable ventilation, which can be defined as the continuous supply of fresh air to indoor environments, and we create livable spaces for you by providing the necessary air quality. All products are also manufactured to comply with environmental requirements.



Fire Safety

One of the biggest threats to human life in case of fire is smoke. It is vital to provide smoke control, to remove smoke and heat from human escape routes and to facilitate the firefighting of the fire department. As NOVVES, we provide smoke evacuation with our car park jet fans, and offer optimum solutions with projecting and CFD analysis.

WHERE WE ARE?

















Novves has sales and services to countries such as United Kingdom, Germany, Saudi Arabia, United Arab Emirates, Qatar, Kuwait, Oman, Bulgaria, Serbia, Bosnia and Herzegovina, Kosovo, Albania, Montenegro, Macedonia, Romania, Lithuania, Georgia, Azerbaijan, Turkmenistan, Uzbekistan, Kazakhstan, Kyrgyzstan, Nigeria, Tunisia, Ghana.

PRODUCT RANGE

NOVVES has a wide range of ventilation products which are smoke extraction fans, jet fans, EC fans, cell fans, duct fans, roof fans, kitchen fans, industrial fans and also manufactures automation panels for smoke evacuation systems. NOVVE'S R&D team develops and manufactures durable and easy-to-assemble uniquely designed products. At the same time, we can develop special solutions for our customers in line with their wishes.

CATCHY PRODUCT ICONS

Novves has assigned a representative animal icon and name to the product groups in order to increase the recall of the products it designs. The fact that the names and symbols of the products are catchy, ensures that the products are easily identified in the project area and saves time.

 <p>Seahorse Bathroom Fan</p>	 <p>Koi Duct Fan</p>	 <p>Heron Roof Fan</p>
 <p>Caracal Heat Recovery Fan</p>	 <p>Fox Shelter Fan</p>	 <p>Turtle Cabinet Fan</p>
 <p>Butterfly Kitchen Fan</p>	 <p>Owl Wall Fan</p>	 <p>Marlin Axial Fan</p>
 <p>Dragonfly Smoke and Heat Extract Fan</p>	 <p>Nautilus Industrial Fan</p>	 <p>Hummingbird EC Fan</p>
 <p>Bear ATEX Fan</p>	 <p>Hound Dampers</p>	 <p>Accessories</p>

RESEARCH & DEVELOPMENT

NOVVES, which offers innovative products with a wide range of project-specific designs, prioritizes energy efficiency and ease of assembly in its products. With its experienced and expert engineers, Novves offers quality and long-lasting products to its customers.

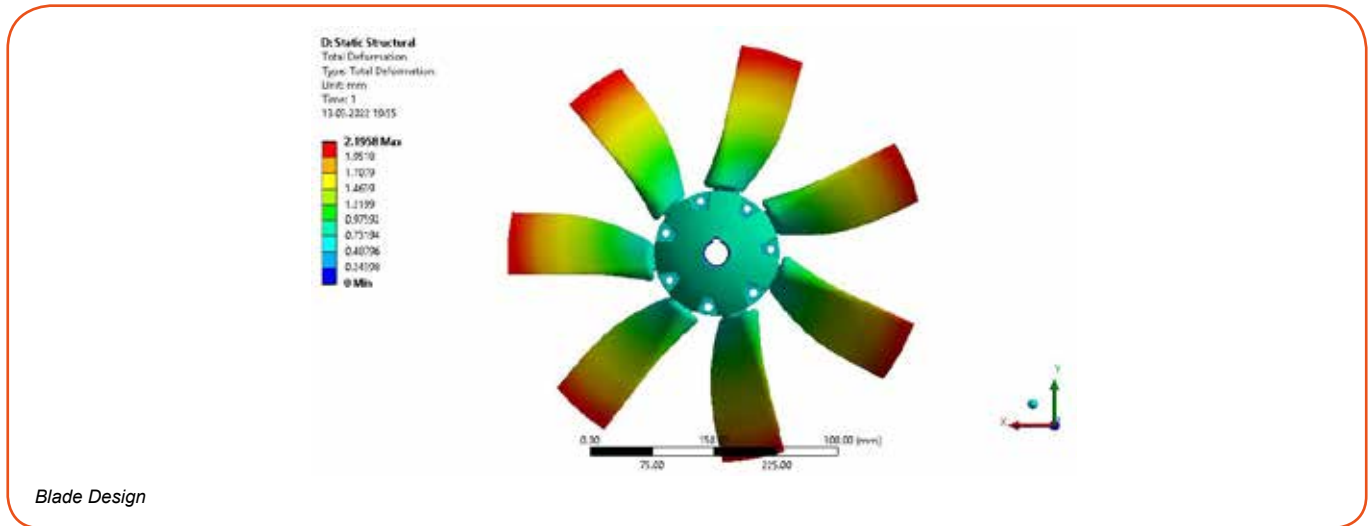

Products suitable for customer needs determined in comprehensive market researches are designed by the R&D team with an innovative perspective in accordance with the price policy determined by the marketing department.

FINITE ELEMENT ANALYSIS (FEA)

Finite Element Analysis is the analysis in which the strength, fatigue, thermal resistance and acoustic values of a material, structure or product are taken using various numerical methods and aerodynamic, thermodynamic and acoustic tests of a flow are made. Today, Finite Element Analysis is done in computer environment. In parallel with the development of information technology, the capacity and success rate of analysis are increasing. Novves uses Finite Element Methods on all fans in the R&D and P&D process. The strength, fatigue, thermal resistance and aerodynamic performances and sound levels of the designed fans are primarily tested with Finite Element Analysis. In this process, which is included in the design process, optimization is continued until the optimum design is achieved. After the optimum design is achieved, the results are verified at the test centers.

Example;

Based on the Von Mises and Maximum Stress principles and taking into account the mechanical weaknesses caused by vibrations, critical areas and safety coefficients are determined before the prototype production.

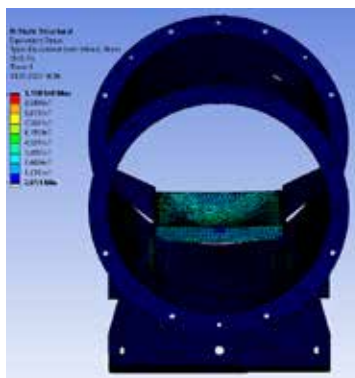

Max stress at 150 kg load, Ø450 Tube (Von Mises Method)

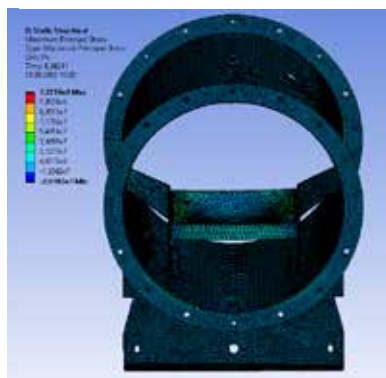

Max stress at 150 kg load, Ø450 Tube

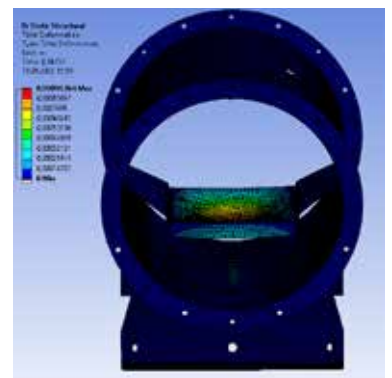

Max stress at 150 kg load, Ø450 Tube Deformation (0,09 mm)

COMPUTATIONAL FLUID MECHANICS (CFD)

Computational Fluid Dynamics (HAD, CFD) is a science in which various thermodynamic and flow equations are solved using numerical methods. 2D and 3D nonlinear equations, which are analytically difficult to solve, can be solved by numerical discretization. The digital network must be created within certain limits. These limits can be listed as Courant number, aspect ratio and skewness values. Novves aims to provide competitive advantage with its unique propeller designs.



Meshing

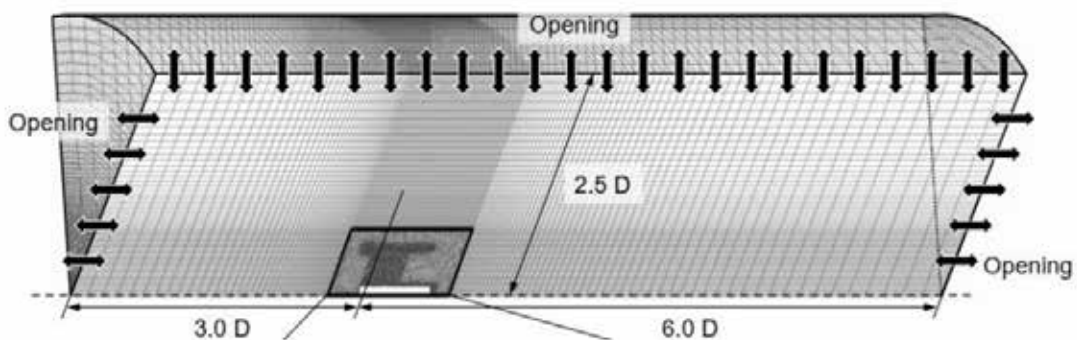

Setting the Boundary Conditions

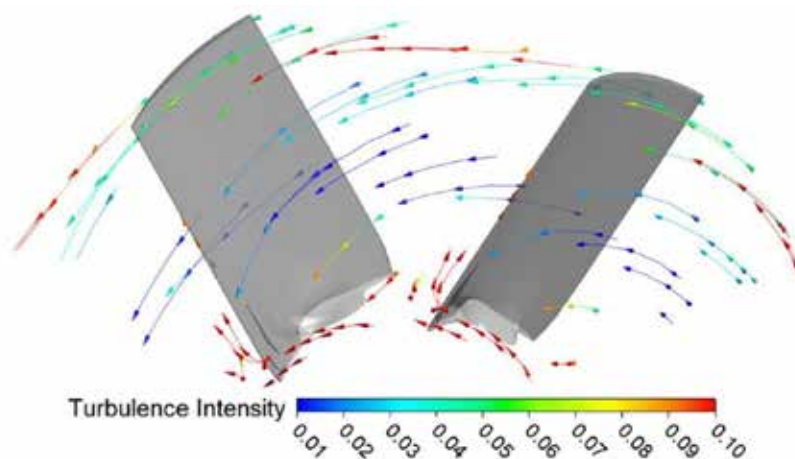

Aerodynamic propellers optimized by CFD analysis are prototyped and verified in the Flow-Pressure Test Center.

NOVVES SYSTEM SOLUTIONS SMOKE CONTROL SYSTEMS

The smoke evacuation or pressurization system works together with other fire systems. It receives information from the fire detection system and the fire extinguishing system and runs the relevant fire scenario accordingly.

Why Smoke Control System?

- Keeping Smoke and Heat away from human escape routes;
- Reducing fire damage to the building by evacuating heat;
- Facilitating fire fighters response by evacuating smoke and heat;
- And to evacuate the smoke left after the fire.

Smoke Control Areas

1-) Escape Stairs Positive Pressurization Systems

In multi-store buildings, the stairwell environment is critical for the safe evacuation of people in the building in the event of a fire. Often the only vertical escape route in high-rise buildings is escape stairs. Pressurization systems are used to remove smoke and heat from escape routes. Novves provide solutions of pressurization including pressurization fans, differential pressure sensors, smoke sensors and automation.

2-) Emergency Elevator Shaft Positive Pressurization Systems

Elevator shaft usually connects all floors in the building so elevator operation can significantly influence pressure distribution in the building. The phenomenon is particularly visible in case of fast moving elevator cars. The resulting danger is about pumping smoke by moving lifts. To eliminate this danger, at the moment of fire detection all the cars should automatically go down and be blocked (with doors open). Fire-fighting elevator shaft shall be pressurized in order to prevent smoke movement.

3-) Atrium Smoke Evacuation Systems

In large-volume closed areas, in the event of a fire, hot smoke is accumulated in the smoke pool determined at the top of the building and evacuated from the roof.

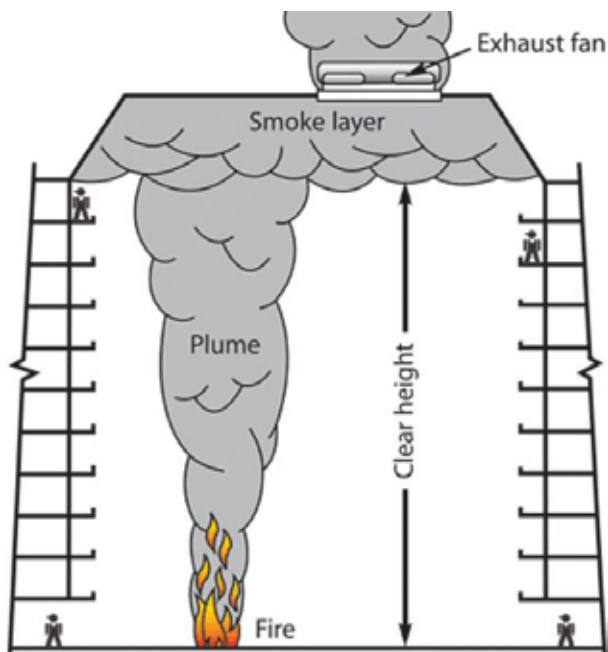

4-) Corridor Smoke Extraction Systems

Smoke control is a complex process involving smoke extraction and fresh air supply by the supply and extract ventilation system of buildings in order to ensure safe evacuation of people in case of a fire in any of the spaces. Systems need their inlet and exhaust each to be close to the opposite ends of the corridor. Corridor damper also required for using the full capacity of fans to corridor prevent spreading smoke to adjacent floors.

5-) Parking Lot and Tunnel Smoke Evacuation System

Number of cars are constantly increasing all over the world and we need parking space. So the park space is essential an enclosed and underground car parks nowadays. When constuctions are built, the demand of car parks is considered. However, there are two main issues about enclosed car parks. One of them is smoke extraction in case of fire, the other one is ventilation in case of polluted air. It is necessary to extract the smoke in the fire zone in order to evacuate people and possible victims. Novves provide smoke extraction with jet fans and solutions with service such as CFD Analyses.

At certain ppm values, CO can cause temporary and permanent damage to the human body. The table below shows the CO limits determined by the World Health Organization (WHO).

Concentration Limit	Exposure Time	Side Effects
35 ppm	6-8 hours	Headache and Dizziness
100 ppm	2-3 hours	Mild headache
200 ppm	2-3 hours	Mild headache, Unconsciousness
400 ppm	2-3 hours	Severe headache
800 ppm	45 minutes	Dizziness, Nausea and Spasms
	2 hours	Sensory loss
1600 ppm	20 minutes	Headache, Increased heart rate, Dizziness, Vomiting
	2 hours	Death
3200 ppm	5-10 minutes	Headache, Dizziness, Vomiting
	30 minutes	Death
6400 ppm	1-2 minutes	Headache and Dizziness
	20 minutes	Convulsions, Respiratory Stop and Death
12800 ppm	2-3 inhalation	Loss of Consciousness
	3 minutes	Death

According to the limits in the table above, the accepted CO concentration in a car park jet fan system design today is in the range of 50 – 100 ppm.

Fire tests must be carried out for each component that makes up the smoke evacuation systems. Novves has successfully completed the certification process of its fans, which withstand 300°C for up to 2 hours in the event of a fire, in accordance with EN 12101-3.

CFD Analysis in Smoke Evacuation System

By using CFD analysis tools, it is possible to perform two types of analysis called daily ventilation and smoke extraction situation. We measure the system performance of the projects carried out within Novves or the projects that reach us from our customers, with CFD analyzes in order to minimize the financial and time loss that our customers will experience before the system is installed. In daily ventilation analysis, we measure the CO evacuation performance of the system, depending on the type of the project, during the time when the vehicle entry-exit is the most intense. In smoke evacuation analysis, we obtain the smoke and heat evacuation performance of the system in accordance with the critical fire points to be specified by our customers and the scenarios of the projects. We create and evaluate CFD analyzes according to the boundary conditions specified in BS – British and NFPA – American standards.

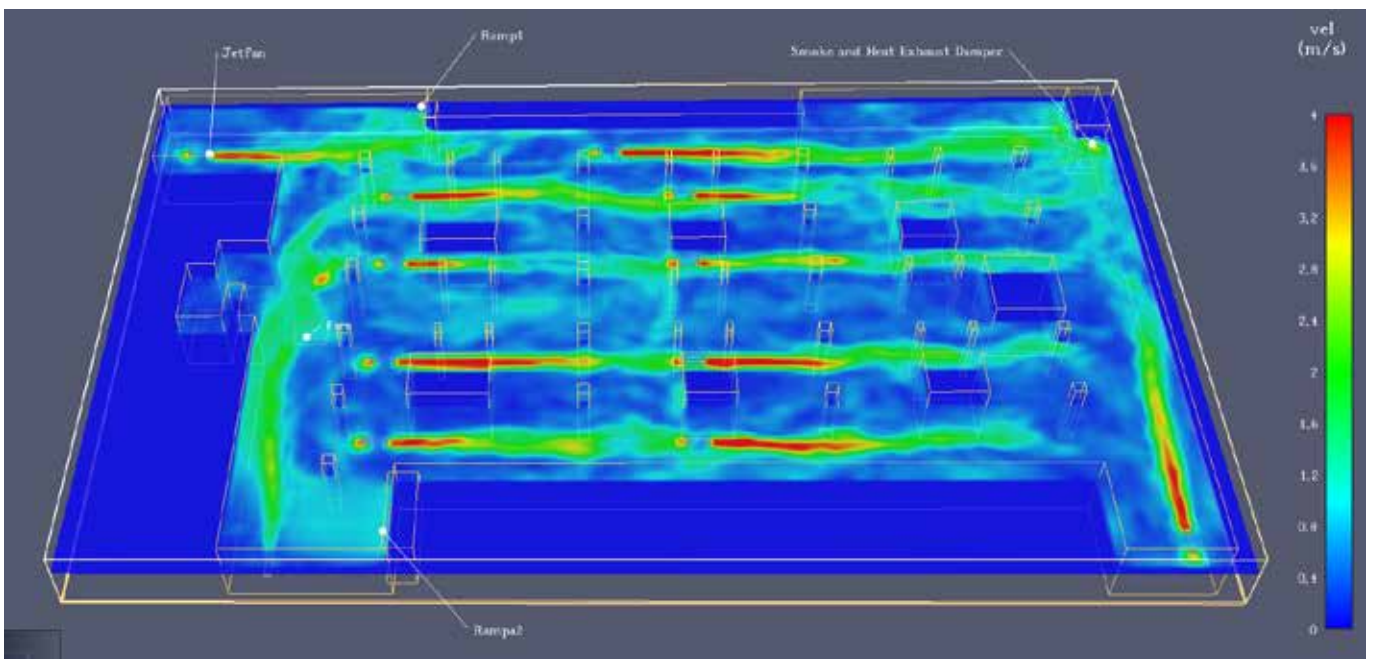

Modelling

Fan placements are made in accordance with the project. Models are made to meet international standards.

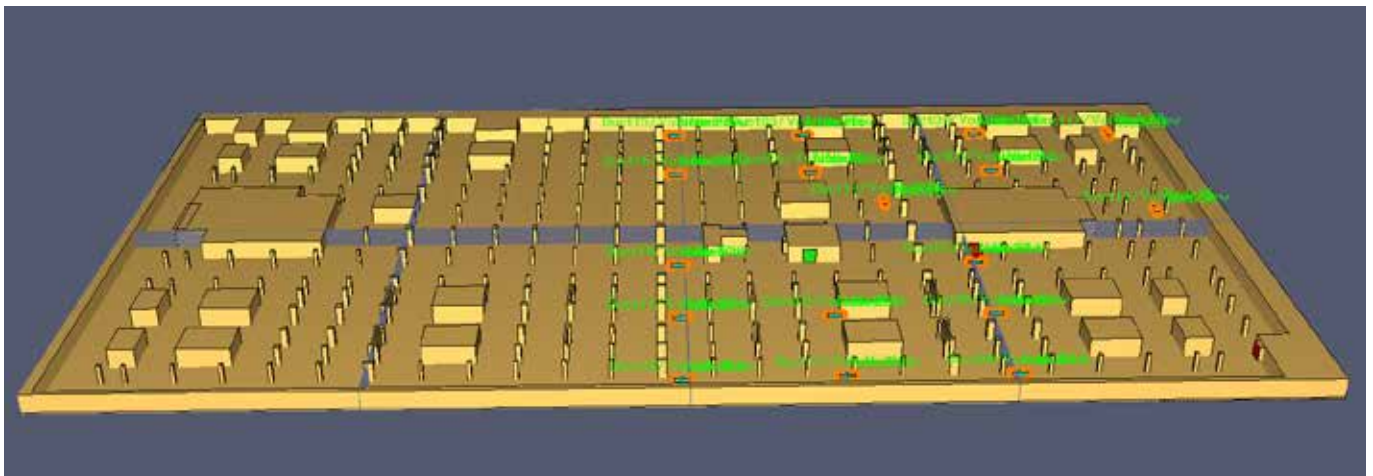

CFD Contours

Visibility

Sight distance is the farthest distance an object can be seen. It is one of the most important parameters in CFD analysis. In the event of a fire, it should be as low as possible to facilitate the fire fighter's response to the fire.

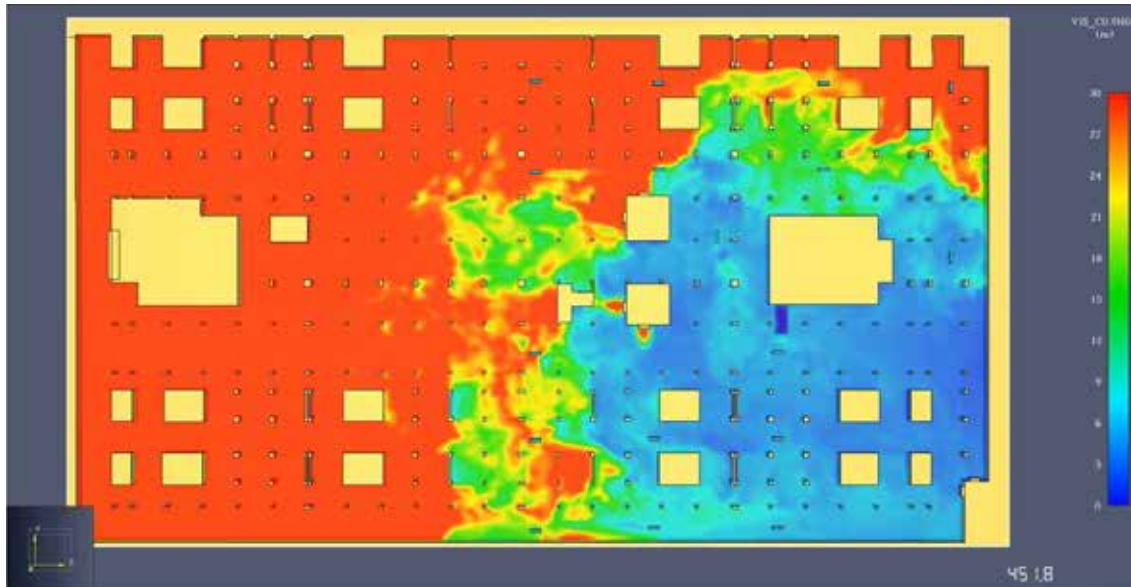

Smoke Distribution

Smoke control systems are used to keep smoke away from human escape routes and to facilitate the intervention of the fire fighters.

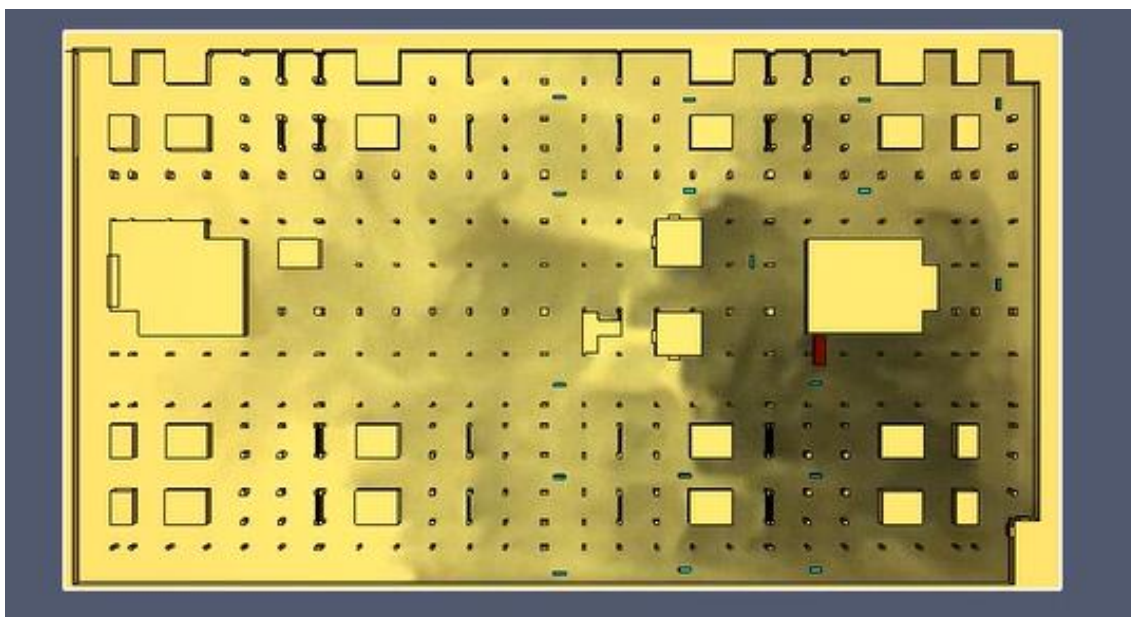

Temperature Distribution

Fire will also increase the ambient temperature significantly. During smoke control, temperature increase that threatens human health should be prevented.

- An environment up to 70°C is considered safe for a long time, albeit uncomfortable.
- At 127°C, breathing problems begin.
- At 140°C, the tolerance is only 5 minutes.
- At 149°C, mouth breathing problems and skin burns begin.

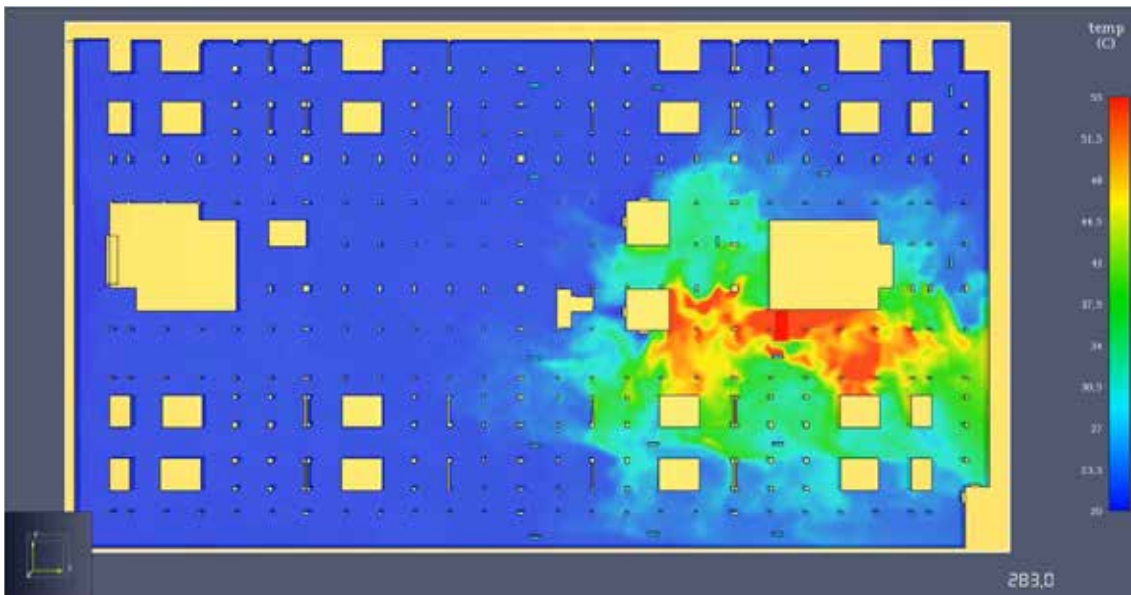

Velocity Profile

Air velocity profiles show the shape and direction of air movement. Velocity profiles should be shaped towards the evacuation direction of the smoke and should not exceed 5 m/s in order not to block the human escape routes.

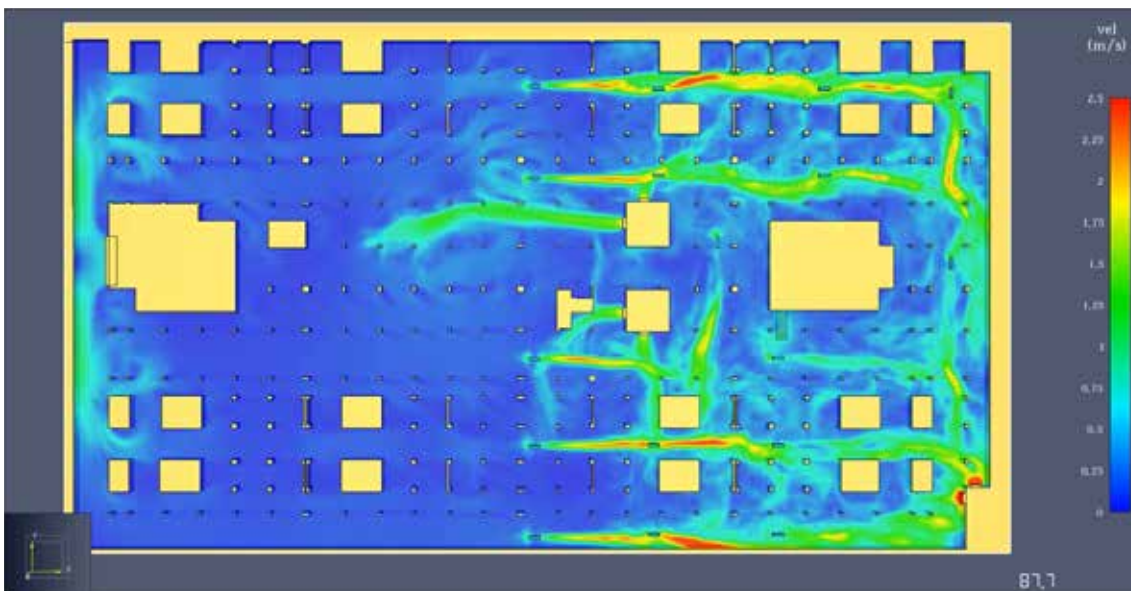

Comfort Ventilation Solution

Air is the most essential resource for our life. Therefore, air quality is one of the most important thing for healthy life. Comfort Ventilation System refers to supply fresh air to indoor consistently. It is supposed to be efficient system which is include fans. Novves provides solutions with fresh air fans, extraction fans, heat recovery devices, axial fans, duct fans, shelter fans in indoor places such as offices, schools, hospitals, airports, hotels, car park, metro stations, tunnels, shopping malls, industrial structures.

Comfort Ventilations has 2 main function.

Comfort Ventilation for Living Being

To supply quality of air where human and other living being lives is involved in this topic.

Comfort Ventilation for Equipment

It is utilized to cool some equipment such as transformer, electrical panel room from outdoor air. These kind of systems are designed for also fresh air needs for tecnical staff.



TESTS WE OFFER FOR THE SYSTEM

Simulation Based Tests

Before the system is commissioned, a fire is started at a point chosen by our customers during the projecting phase, and the system is tested with CFD analysis.

Functional Tests

After the installation and commissioning of the system are completed, functional tests are performed for CO Evacuation and Smoke Evacuation. Before the test, mechanical and electrical controls of axial fans, jet fans and dampers are done in the same way as automation panel control. The functionality of CO detection, smoke detection and similar devices is examined by our customers. It is verified that the CO and Fire signals reach the automation panel correctly. It is ensured that the jet fans, axial fans and dampers work as specified in the scenarios prepared in accordance with the application projects. To ensure that the smoke evacuation mode is working correctly and successfully, we perform tests via the smoke machine at a location chosen by our customers.

TECHNICAL SERVICES

For annual maintenance services and the repair services in case of breakdown.

Security precautions

- Maintenance – performed by persons authorized by Novves.
- Before starting the maintenance, it is recommended to wear safety glasses, hard hat and safety gloves for work safety reasons.
- Before checking the electrical connections of devices, make sure that the main switch is off.
- Maintenance should not be started until the fan has completely stopped.
- It must be ensured that the working area is free from smoke, dust, heat, toxic gas, etc.

Maintenance Operations

Depending on the type of building (shopping mall, residence, business center, etc.) in which the system is located, and depending on the cleanliness of the environment and the operating period of the system, the following checks are made on average once a year and necessary precautions are taken.

- There is a risk of particle accumulation in the rotor part. This may cause the fan to become unbalanced and cause eccentricity. Therefore, the rotor part of the fan must be cleaned.
- The motor, the inside of the motor and the inner surface of the fan body should be cleaned. If excessive dust accumulation is detected inside the engine, dry air may be blown into the motor.
- Mechanical and electrical connections of all dampers and fans should be checked.
- All electrical cables should be checked.
- The voltage and amperage drawn by the motors should be checked.
- Vibration isolators, suspension feet of jet fans, profiles on which axial fans are supported and support elements of similar components should be checked.
- In case of any corrosion on fans, fan components and dampers, necessary cleaning and maintenance procedures should be performed.
- To ensure homogeneous distribution of oil in the fan bearings, the fan should be run for 2 hours at least once a month.
- To ensure that the emergency control and management system is functional, the system should be checked by running it for at least 15 minutes once a month.
- If there is an anti-condensation resistor, the rated currents should be checked at least once a month to make sure it works automatically when the motor is stopped.
- In unexpected and worrying situations, you can contact Novves Technical Service team at any time.

FACTORY INTEGRATION POLICY

Within the scope of its Integrated Management System, NOVVES GROUP, produces fans and fan accessories and automation panels and provides engineering services for the construction and industrial production sectors in the fields of fire safety and comfort ventilation in accordance with ISO 9001:2015, TS EN ISO -14001:2015, TS EN ISO 45001:2018 standards.

NOVVES GROUP has determined the following as its integration policy:

- An understanding that always aims to meet the changing needs and expectations of the customer by acting with the focus of customer satisfaction in the whole process from the very beginning of the production to the after-sales;
- To increase the efficiency in all our processes to a level that can compete at the international level in line with the continuous improvement approach;
- To create quality awareness in all its employees;
- To be fair and reliable in our work;
- To contribute to the country's economy by developing business volume in line with the global competition conditions, taking into account the country and region conditions, and respecting the society and the environment;
- To enable human resources to develop their knowledge, skills and competencies;
- To execute an effective corporate risk strategy;
- To comply with current laws and regulations;
- To protect the environment while conducting our business;
- To use energy, raw materials and natural resources in the most efficient way;
- To set an example for the sector in terms of human health and environmental awareness by using the latest technology that does not harm or the least harmful for human health and the environment during its activities;
- To take all kinds of waste disposal as a loss of natural resources and to develop methods to prevent pollution at its source;
- To develop innovative solutions in its products and processes to combat climate change;
- To minimize energy and water consumption, waste generation and water and air emissions by training its employees and using continuous improvement tools;
- To protect all human resources within the boundaries of the enterprise with a proactive and lean occupational safety approach;
- To prevent injuries and health problems caused by work accidents by creating safe working areas and a culture of work safety.



PRODUCT FAMILY

					Page
	Seahorse Bathroom Fan				19
	Koi Duct Fan				25
	Heron Roof Fan				37
	Caracal Heat Recovery Fan				67
	Fox Shelter Fan				73
	Butterfly Kitchen Fan				81
	Turtle Cabinet Fan				87
	Owl Wall Fan				115

				Page
	Marlin Axial Fan			165
	Dragonfly Smoke and Heat Extract Fan			207
	Nautilus Industrial Fan			277
	Hummingbird EC Fan			285
	Bear ATEX Fan			293
	Hound Dampers			317
	Accessories			329

NOVVES

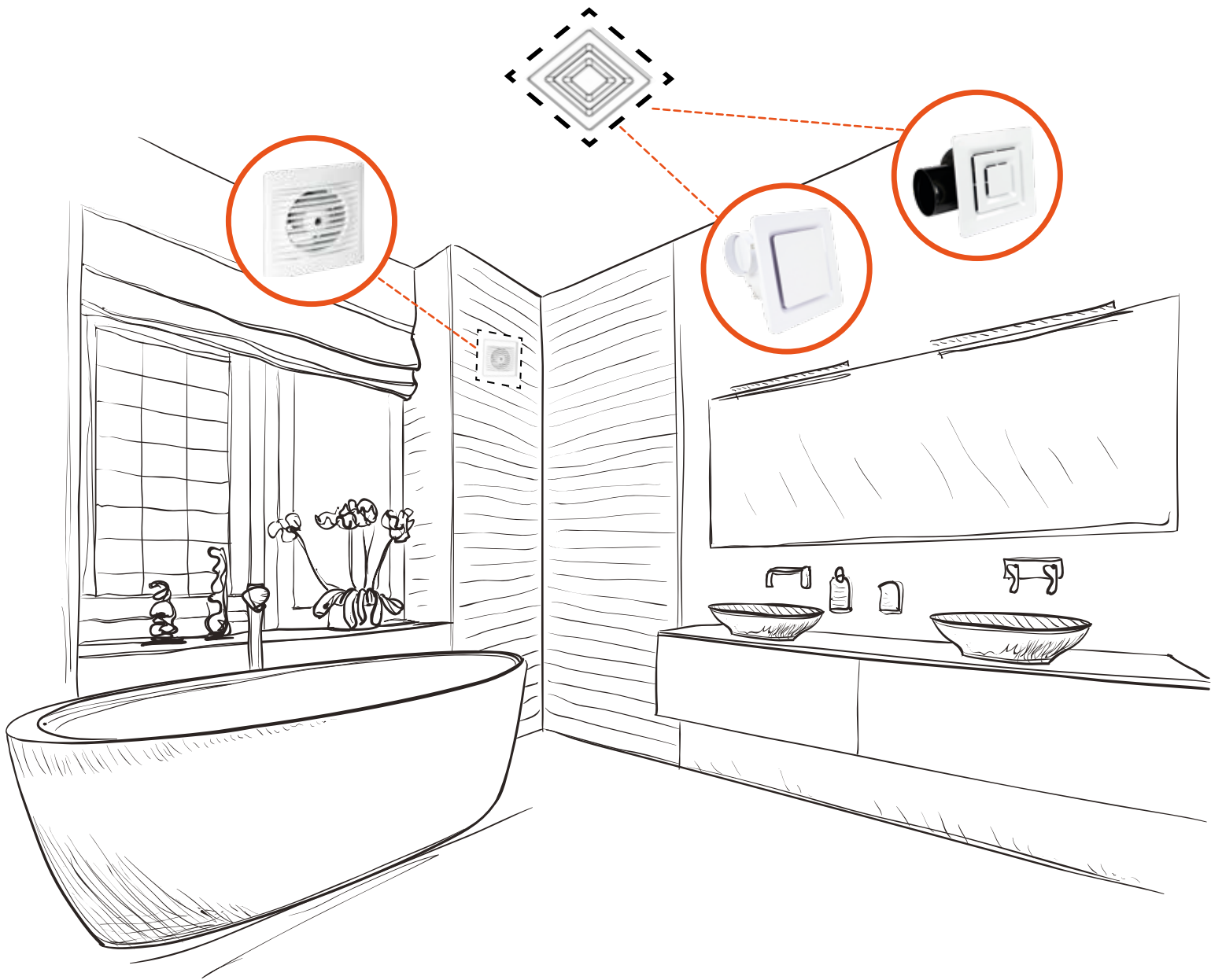

Seahorse
Bathroom Fan



SEAHORSE SERIES

General

It is used in small and medium volume areas such as bathrooms, toilets, cellars and similar areas to quickly evacuate bad odor and steam. The Seahorse-RP series offers easy mounting on the ceiling and the Seahorse-AP series on the window, shaft or wall, and also provides an aesthetic appearance.

It is produced in accordance with EN 60335-2-80, Low Voltage Equipment – 2006/95/EC and Electromagnetic Compatibility- 2004/108/EC standards.

It is suitable for operation up to 40°C air temperature.

Body

The body is made of ABS plastic, which is resistant to external factors and corrosion. The front panel is thin and robust, and can be easily disassembled and cleaned in case of dust accumulation over time. The return flap, which is produced as standard in radial fan series and optional in axial fan series, prevents polluted air that may come from outside when the fan is not operating, and also prevents heat loss that may leak from inside to outside.

Thanks to its specially designed body and front cover, the Seahorse-RP series provides a peaceful environment by operating ultra-quietly with high suction power in all directions.

Impeller

Fan blades are aerodynamically designed and provide regular flow.

Seahorse-AP series have axial and Seahorse-RP series have radial plastic fans.

Motor

The motor has thermal protection and is long-lasting against environmental factors. Thanks to self-lubricating and maintenance-free motor bearings, the Seahorse series operates quietly. The motor insulation class is B.

IP Class

It is Class II insulated against water splash and has IP X4 protection class.

Control

Depending on preference, it can be operated directly with a light switch or on/off switch. After the switch is closed, the running time of the fan can be adjusted with a time-delayed electronic card (optional). The speed can be adjusted between 0-100% with the speed switch accessory.

Fan Code

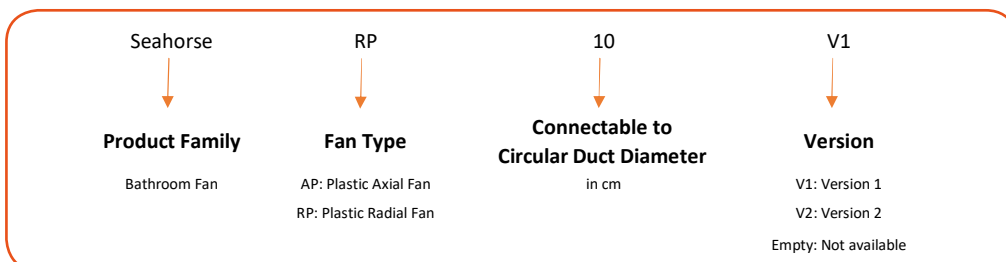

AXIAL BATHROOM FANS



- Manufactured from high quality ABS plastic
- Suitable for wall and window mounting
- IP44 protection against splashing water

SEAHORSE AP - SYSTEM CURVE

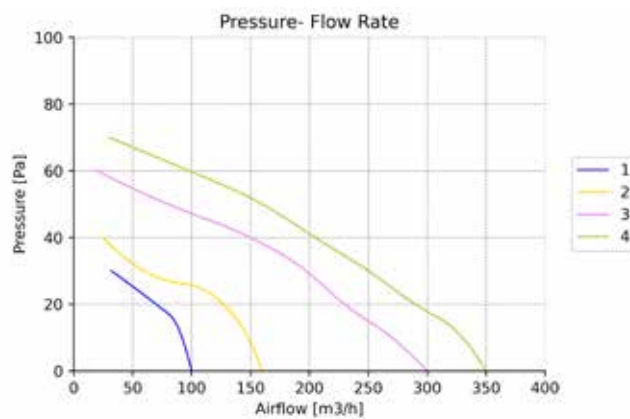

TECHNICAL PARAMETERS

MODEL	MODEL NUMBER	Voltage-Frequency	Motor Power	Current	Rotation Speed	Sound Pressure	Protection Class	Working Range	Mass
		V-Hz	W	A	RPM	Lp(A) dB at 3m	IP	°C	Kg
SEAHORSE AP 10	1	230-50	12	0,1	2200	30	44	-30 / 40	0,5
SEAHORSE AP 12	2	230-50	16	0,13	2200	33	44	-30 / 40	0,6
SEAHORSE AP 15	3	230-50	32	0,32	2100	39	44	-30 / 40	1
SEAHORSE AP 20	4	230-50	44	0,42	2000	42	44	-30 / 40	1,4

PRODUCT DIMENSIONS

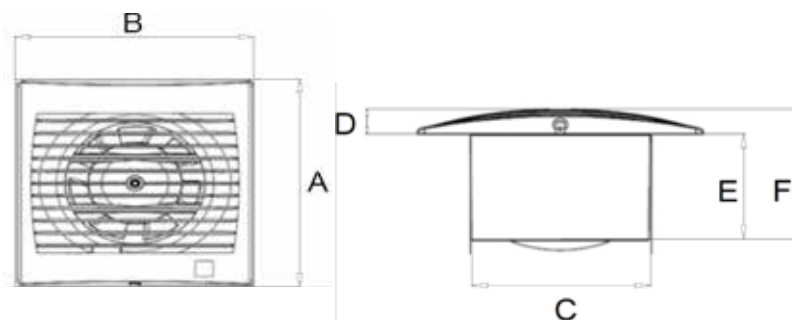

MODEL	A	B	C	D	E	F
SEAHORSE AP 10	158	158	100	14,5	64,5	79
SEAHORSE AP 12	183,5	183,5	120	15	76	91
SEAHORSE AP 15	220,5	220,5	159	16,5	87	103,5
SEAHORSE AP 20	270	270	210	17	86,5	103,5

CEILING BATHROOM FANS



- Manufactured from high quality ABS plastic
- Suitable for ceiling mounting
- IP34 protection against splashing water
- With backdraft damper

SEAHORSE RP V1 - SYSTEM CURVE

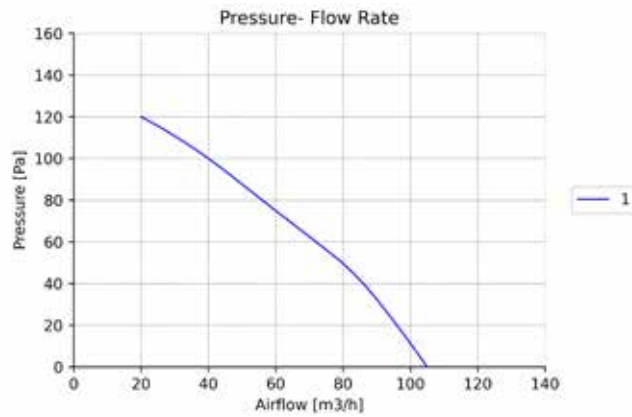

TECHNICAL PARAMETERS

MODEL	MODEL NUMBER	Voltage Frequency	Motor Power	Current	Rotation Speed	Sound Pressure	Protection Class	Working Range	Mass
		V-Hz	W	A	RPM	Lp(A) dB at 3m	IP	°C	Kg
SEAHORSE RP 20 V1	1	230-50	23	0,21	2100	29	34	-30/40	1

PRODUCT DIMENSIONS

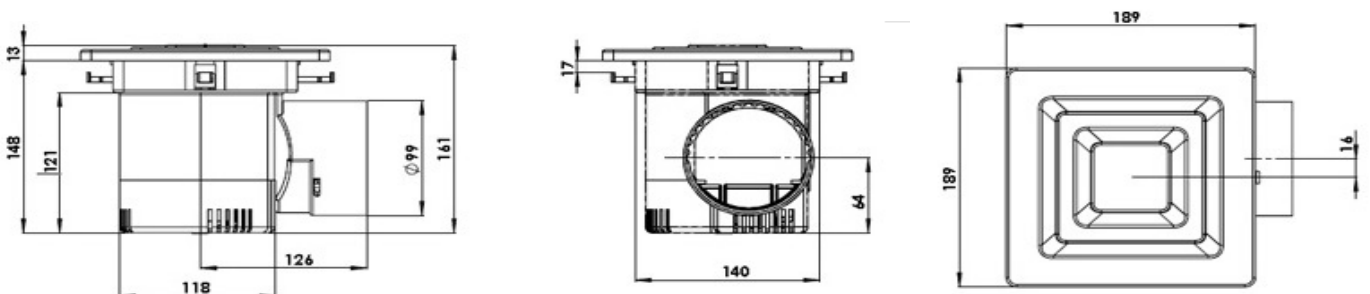

CEILING BATHROOM V2 FANS



- Manufactured from high quality ABS plastic
- Suitable for ceiling mounting
- IP24 protection against splashing water
- With backdraft damper
- Low Noise Level

SEAHORSE RP V2 - SYSTEM CURVE

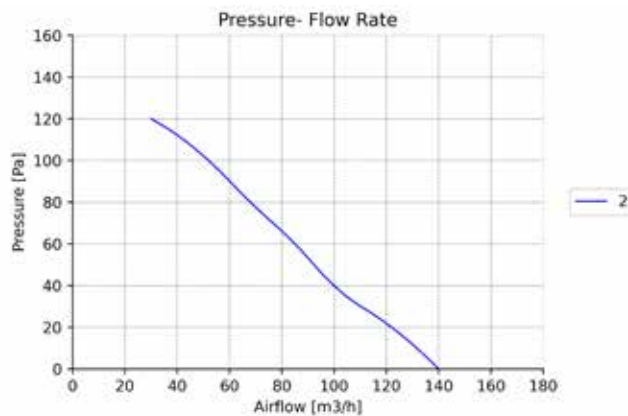

TECHNICAL PARAMETERS

MODEL	MODEL NUMBER	Voltage Frequency	Motor Power	Current	Rotation Speed	Sound Pressure	Protection Class	Working Range	Mass
		V-Hz	W	A	RPM	Lp(A) dB at 3m	IP	°C	Kg
SEAHORSE RP 20 V2	2	230-50	32	0,21	1050	29	24	-30/40	1,1

PRODUCT DIMENSIONS

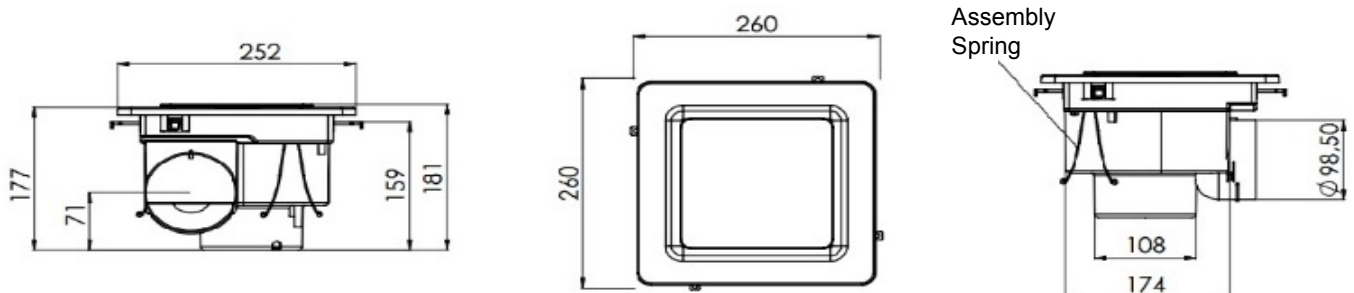

NOVVES

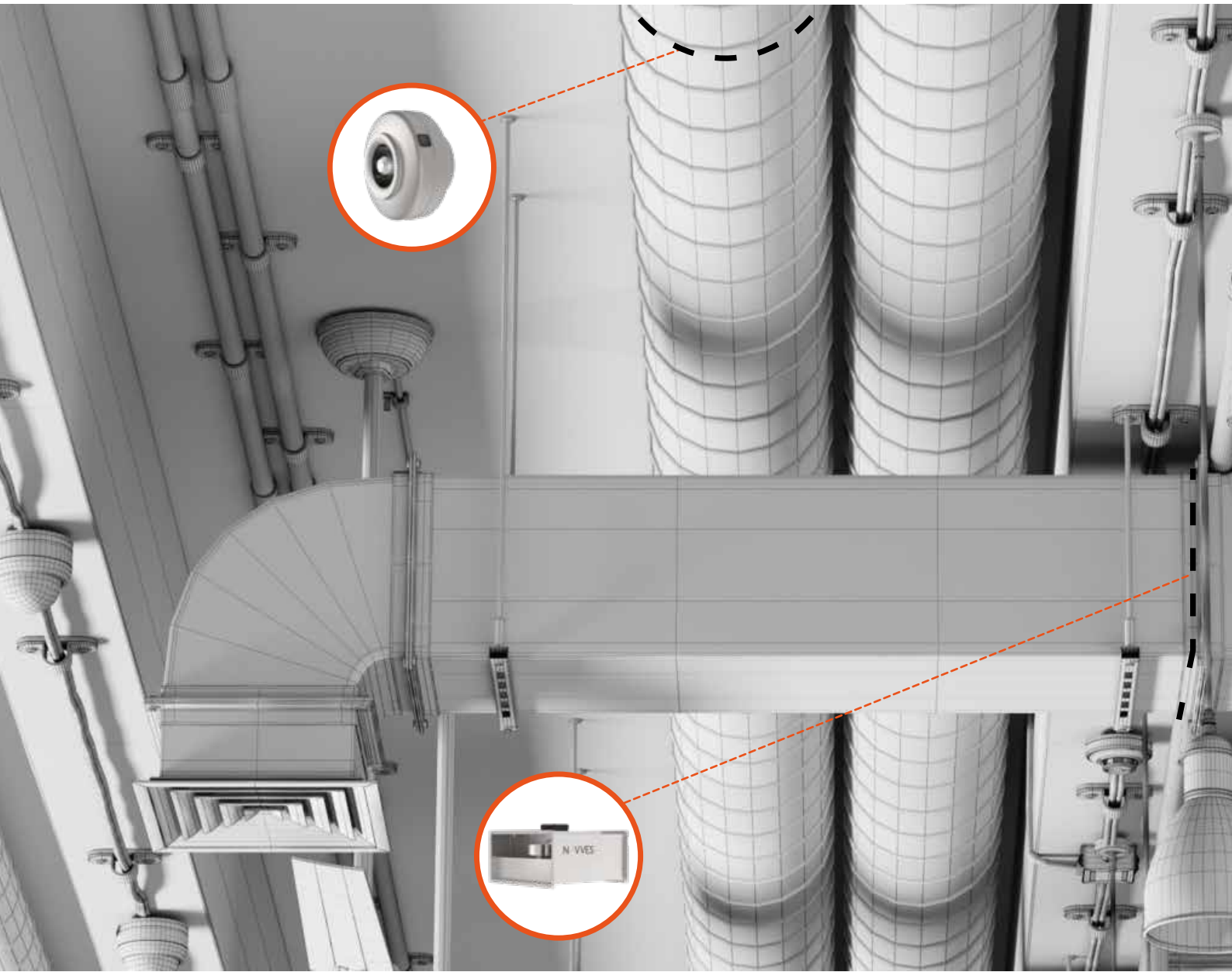

Koi
Duct Fan



KOI SERIES

General

Designed to meet low and medium volume ventilation requirements, the KOI series can be easily installed in any required position thanks to its compact structure. While this series provides strong air suction, it also works at optimum sound level. It can be used as a fresh air or exhaust fan depending on preference. CB, RB, X Series fans can operate at high performance up to a maximum of 40°C. Fans in the Reb series can be used to evacuate hot air up to a maximum of 120°C, since the motor is out of the air flow.

Body

The bodies of the KOI RB, REB, CB Series are made of high quality galvanized steel, and the housing of the KOI X Series is made of high quality composite plastic. Suction and discharge openings are suitable for duct mounting. Except for the X series, there is an option to be produced with electrostatic powder paint.

Impeller

CB, RB, REB Series are designed with backward curved bladed radial fans, and X Series are designed with mixed flow radial fans. Propellers are dynamically and statically balanced in accordance with ISO 1940.

Motor

All of the REB Series and some models of the RB Series are designed as asynchronous motors. The motors of the other models are external rotor motors with a closed structure. IP55 protection class junction boxes on the body, provide convenience in terms of electrical connection.

IP Class

Fans of KOI CB, RB, X Series are IP 44 protection, F insulation class. KOI REB Models are IP 55 protection, F insulation class.

Control

Fans in this series can be operated directly with the on/off switch. The speed of the models with single-phase motors is adjusted with the speed switch, while the speed of the models with three-phase motors is adjusted with the frequency inverter.

Fan Code

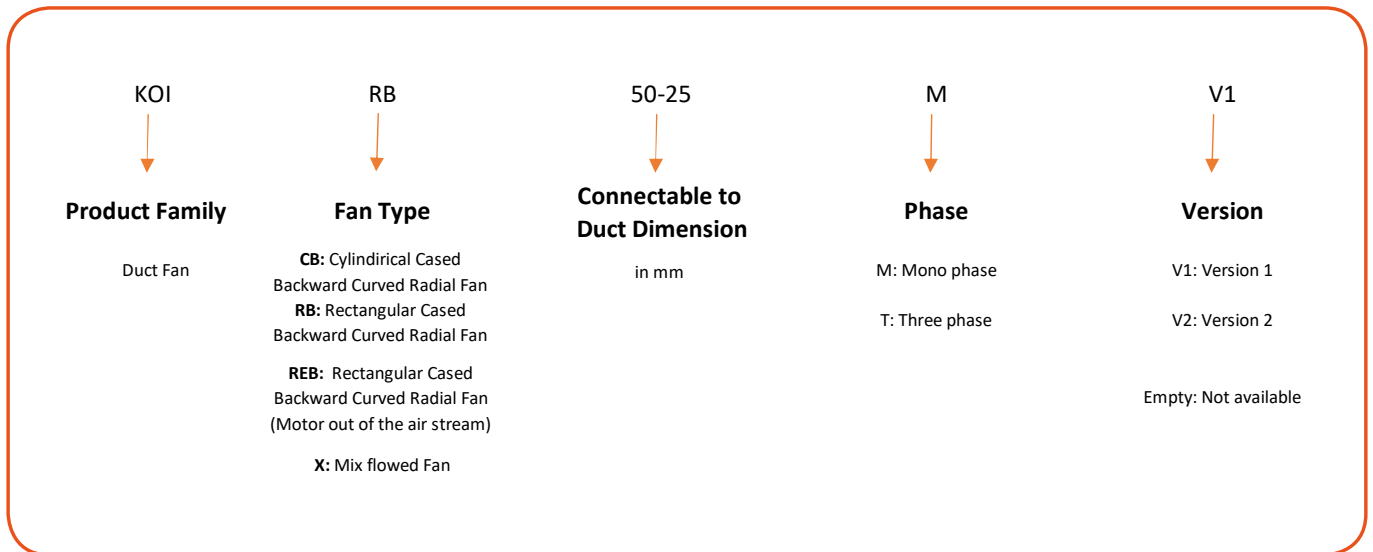

Accessories

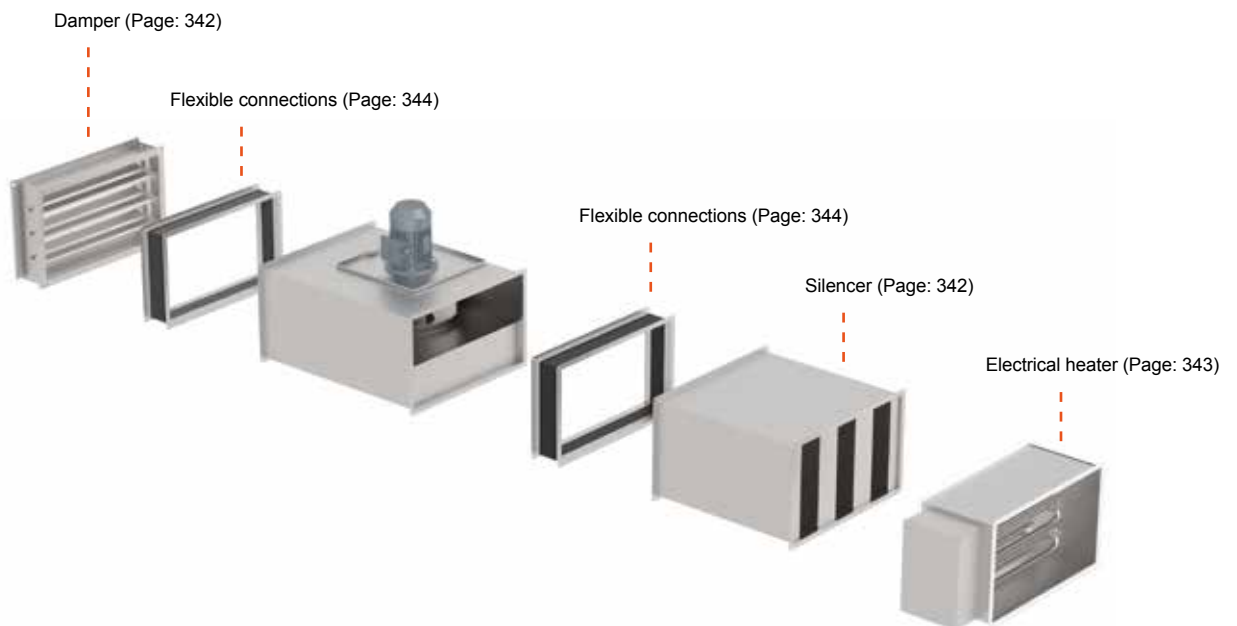

INLINE ROUND DUCT FANS



- IP44 protection class, F insulation
- High efficiency backward curved impeller
- Vertical or horizontal installation possibility
- Suitable for aspiration or ventilation depending on the mounting direction
- Rotational speed can be set with speed controller and frequency inverter

KOI CB - SYSTEM CURVE

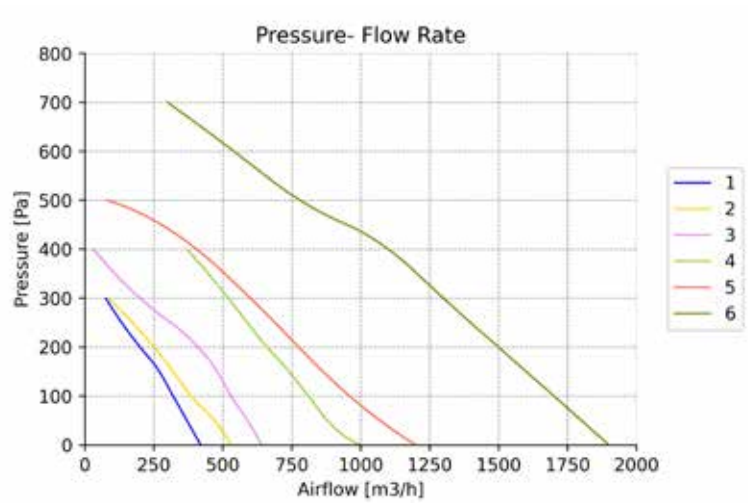

TECHNICAL PARAMETERS

MODEL	MODEL NUMBER	Volta-ge-Frequency	Motor Power	Current	Rotation Speed	Sound Pressure	Protection Class	Working Range	Mass
		V-Hz	W	A	RPM	Lp(A) dB at 3m	IP	°C	Kg
KOI CB 100M	1	230-50	68	0,28	2400	42	44	-25/60	2,6
KOI CB 125M	2	230-50	76	0,29	2350	43	44	-25/60	2,7
KOI CB 150M	3	230-50	110	0,47	2200	47	44	-25/60	3,2
KOI CB 200M	4	230-50	160	0,7	2600	52	44	-25/60	5
KOI CB 250M	5	230-50	180	0,66	2600	57	44	-25/60	5,5
KOI CB 315M	6	230-50	285	0,83	2500	68	44	-25/60	6,9

PRODUCT DIMENSIONS

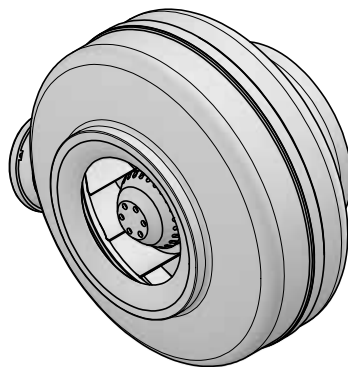
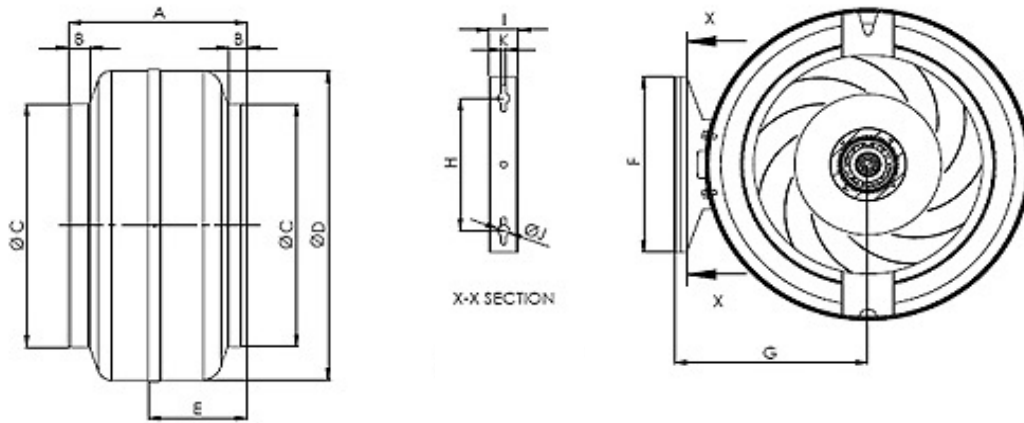

MODEL	A	B	C	D	E	F	G	H	I	J	K
KOI CB 100M	210	26	98	233	124	225	157	170	35,5	14	6,5
KOI CB 125M	203	26	123	233	110	225	157	170	35,5	14	6,5
KOI CB 150M	230	30	149	322	125	225	200	170	35,5	14	6,5
KOI CB 200M	228	30	199	342	130	225	210,5	170	35,5	14	6,5
KOI CB 250M	227	30	248	342	130	225	210,5	170	35,5	14	6,5
KOI CB 315M	220	26	311	397	122	225	238	170	35,5	14	6,5

INLINE RECTANGULAR DUCT FANS



- IP44 protection class, F insulation
- High efficiency backward curved impeller
- Suction and discharge side are self-flanged
- Vertical or horizontal installation possibility
- Suitable for aspiration or ventilation depending on the mounting direction
- Rotational speed can be set with speed controller and frequency inverter

KOI RB - SYSTEM CURVE

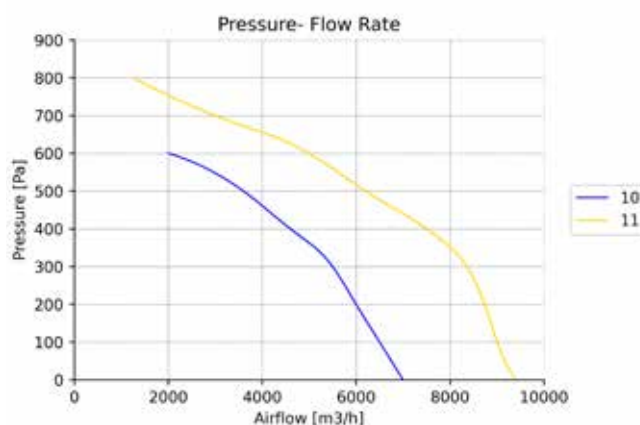
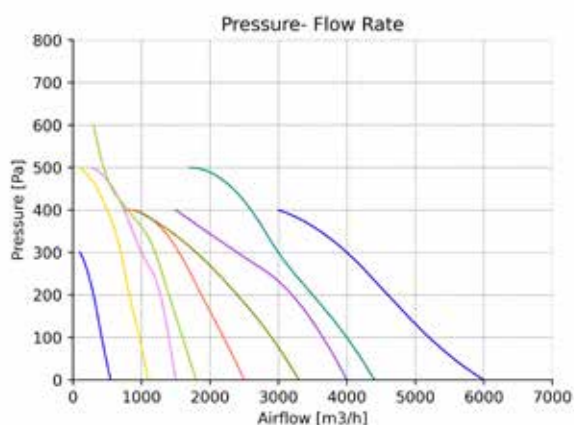

TECHNICAL PARAMETERS

MODEL	MODEL NUMBER	Voltage	Motor	Current	Rotation	Sound	Protection	Working	Mass
		Frequency	Power		Speed	Pressure		Range	
		V-Hz	W	A	RPM	Lp(A) dB at 3m	IP	°C	Kg
KOI RB 30 15M	1	230-50	60	0,35	2700	57	44	-30/60	6,5
KOI RB 40 20M	2	230-50	135	0,6	2600	59	44	-30/60	10,5
KOI RB 50 25MV1	3	230-50	230	1,05	2700	61	44	-30/60	14
KOI RB 50 25MV2	4	230-50	230	1,1	2450	68	44	-30/60	16
KOI RB 60 35MV1	5	230-50	210	1	1400	52	44	-30/60	26
KOI RB 60 35MV2	6	230-50	400	2,6	1400	66	44	-30/60	29
KOI RB 70 40MV1	7	230-50	430	1,5	1380	58	44	-30/60	35
KOI RB 70 40MV2	8	230-50	510	1,5	1380	55	44	-30/60	36
KOI RB 80 50TV1	9	400-50	800	3,5	1350	68	54	-30/60	42
KOI RB 80 50TV2	10	400-50	1100	2,5	1400	71	54	-30/60	48
KOI RB 100 50T	11	400-50	1500	2,6	1400	69	54	-30/60	70

PRODUCT DIMENSIONS

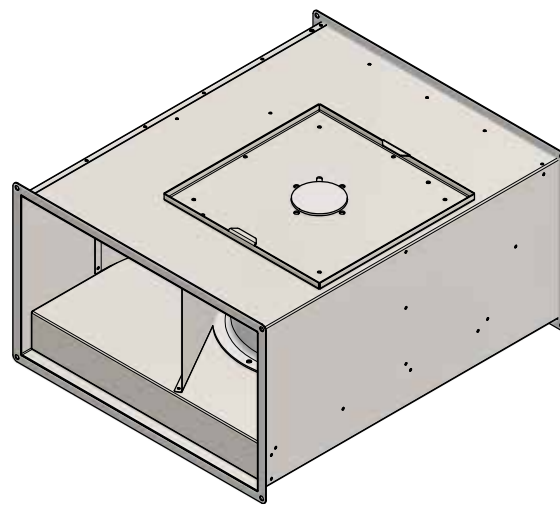
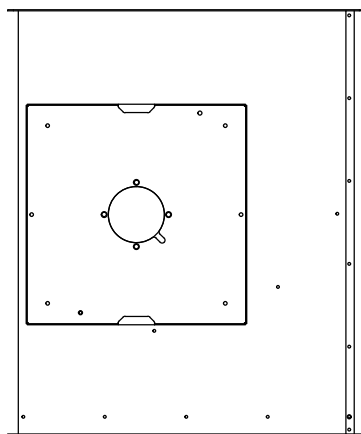
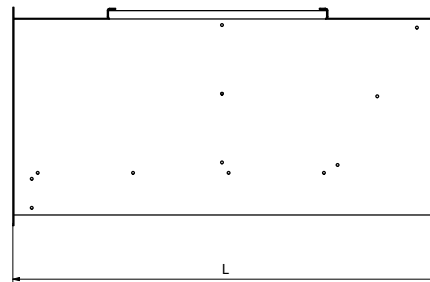
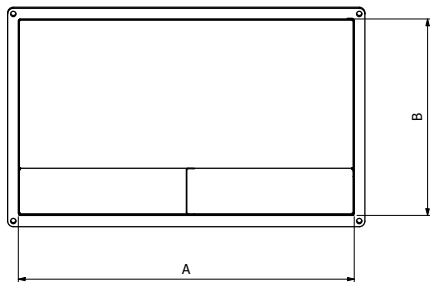

MODEL	A (mm)	B (mm)	L (mm)
KOI RB 30 15M	300	150	390
KOI RB 40 20	400	200	500
KOI RB 50 25MV1	500	250	500
KOI RB 50 25MV2	500	250	500
KOI RB 60 35MV1	600	350	760
KOI RB 60 35MV2	600	350	760
KOI RB 70 40MV1	700	400	800
KOI RB 70 40MV2	700	400	800
KOI RB 80 50TV1	800	500	800
KOI RB 80 50TV2	800	500	800
KOI RB 100 50T	1000	500	1000

INLINE RECTANGULAR DUCT FANS WITH EXTERNAL MOTOR



- Body manufactured from high quality galvanized sheet
- IP55 protection class, F insulation
- High efficiency backward curved impeller
- Suction and discharge side are self-flanged
- Vertical or horizontal installation possibility
- Motor outside the air stream
- 120°C continuous operation
- Rotational speed can be set with frequency inverter

KOI REB - SYSTEM CURVE

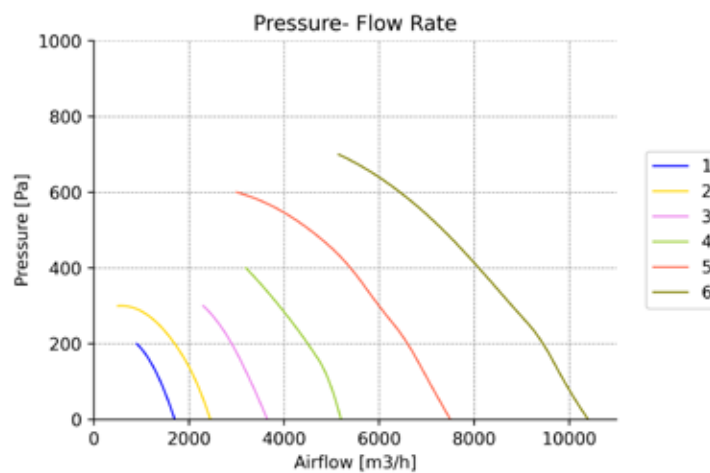

TECHNICAL PARAMETERS

MODEL	MODEL NUMBER	Voltage Frequency	Motor Power	Current	Rotation Speed	Sound Pressure	Protection Class	Working Range	Mass
		V-Hz	kW	A	RPM	Lp(A) dB at 3m	IP	°C	Kg
KOI REB 50 25T	1	400-50	0,25	0,27	1450	55	55	-25/60	18
KOI REB 60 35TV1	2	400-50	0,25	0,8	1450	58	55	-25/60	29
KOI REB 60 35TV2	3	400-50	0,37	1,2	1450	62	55	-25/60	30
KOI REB 70 40TV1	4	400-50	0,55	2,1	1450	73	55	-25/60	37
KOI REB 80 50T	5	400-50	1,1	3,6	1450	77	55	-25/60	47,5
KOI REB 100 50T	6	400-50	1,5	5,3	1450	70	55	-25/60	72

PRODUCT DIMENSIONS

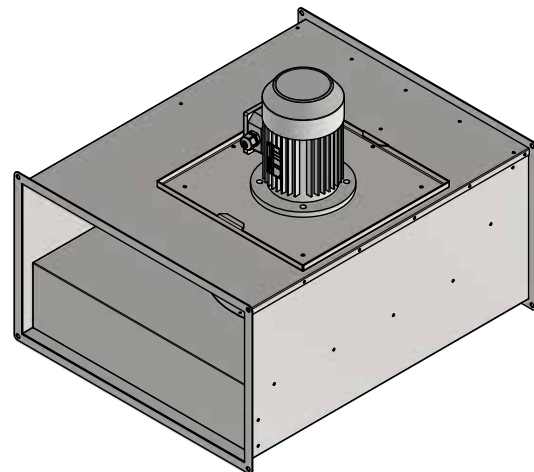
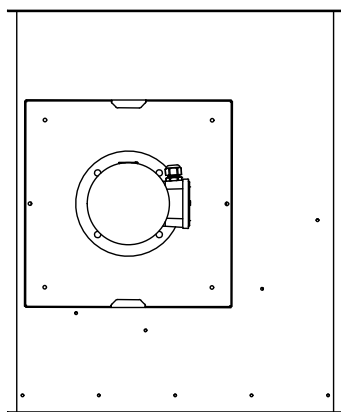
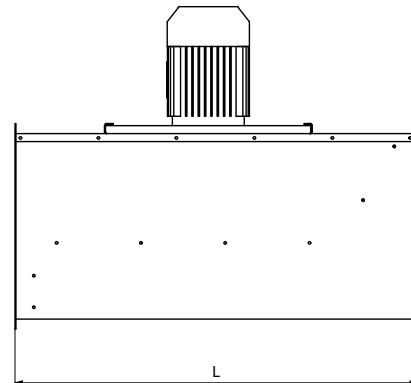
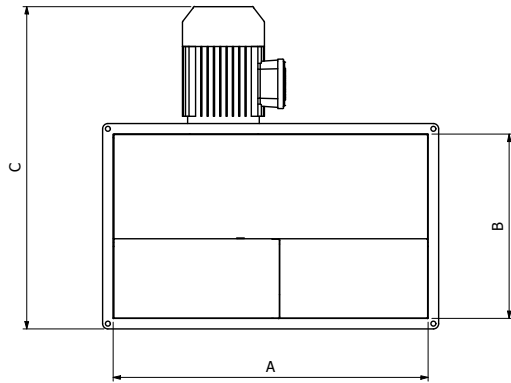

MODEL	A (mm)	B (mm)	C (mm) (maks.)	L (mm)
KOI REB 50 25T	500	250	480	500
KOI REB 60 35TV1	600	350	600	760
KOI REB 60 35TV2	600	350	600	760
KOI REB 70 40TV1	700	400	650	800
KOI REB 80 50T	800	500	800	800
KOI REB 100 50T	1000	500	800	1000

INLINE ROUND MIXFLOW DUCT FANS



- Body is manufactured high quality plastic body
- Double speed fan motor
- IP44 protection class
- Low noise level
- Easy to install and maintain
- Rotational speed can be set with speed
- Suitable for aspiration or ventilation

KOI X - SYSTEM CURVE

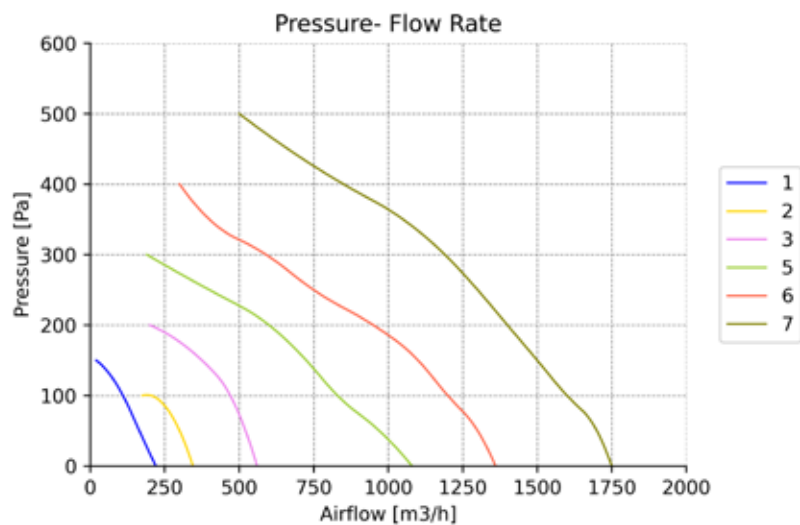

TECHNICAL PARAMETERS

MODEL	MODEL NUMBER	Voltage	Motor	Current	Rotation Speed	Sound	Protection Class	Working	Mass
		Frequency	Power			Pressure		Range	
		V-Hz	W	A	RPM	Lp(A) dB at 3m	IP	°C	Kg
KOI X 100M	1	230-50	25	0,11	2015	44	44	0/+60	4,5
KOI X 125M	2	230-50	29	0,13	2315	48	44	0/+60	4,6
KOI X 150M	3	230-50	50	0,23	2640	53	44	0/+60	6,1
KOI X 160M	4	230-50	50	0,23	2640	53	44	0/+60	6,3
KOI X 200M	5	230-50	108	0,49	2460	56	44	0/+60	8
KOI X 250M	6	230-50	177	0,79	2460	58	44	0/+60	15
KOI X 315M	7	230-50	315	1,41	2600	60	44	0/+60	25

PRODUCT DIMENSIONS

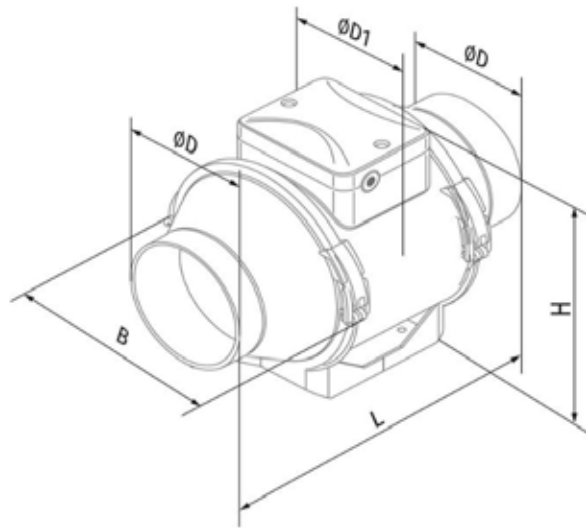

MODEL	ØD	ØD1	B	H	L	KG
KOI X 100M	97	164	196	241	303	2
KOI X 125M	123	164	196	241	258	2
KOI X 150M	148	187	220	251	289	2,1
KOI X 160M	158	187	220	251	289	2,5
KOI X 200M	199	209	239	261	295,5	3,5
KOI X 250M	247	257	287	323	383	8
KOI X 315M	310	323	362	408	445	11

NOVVES

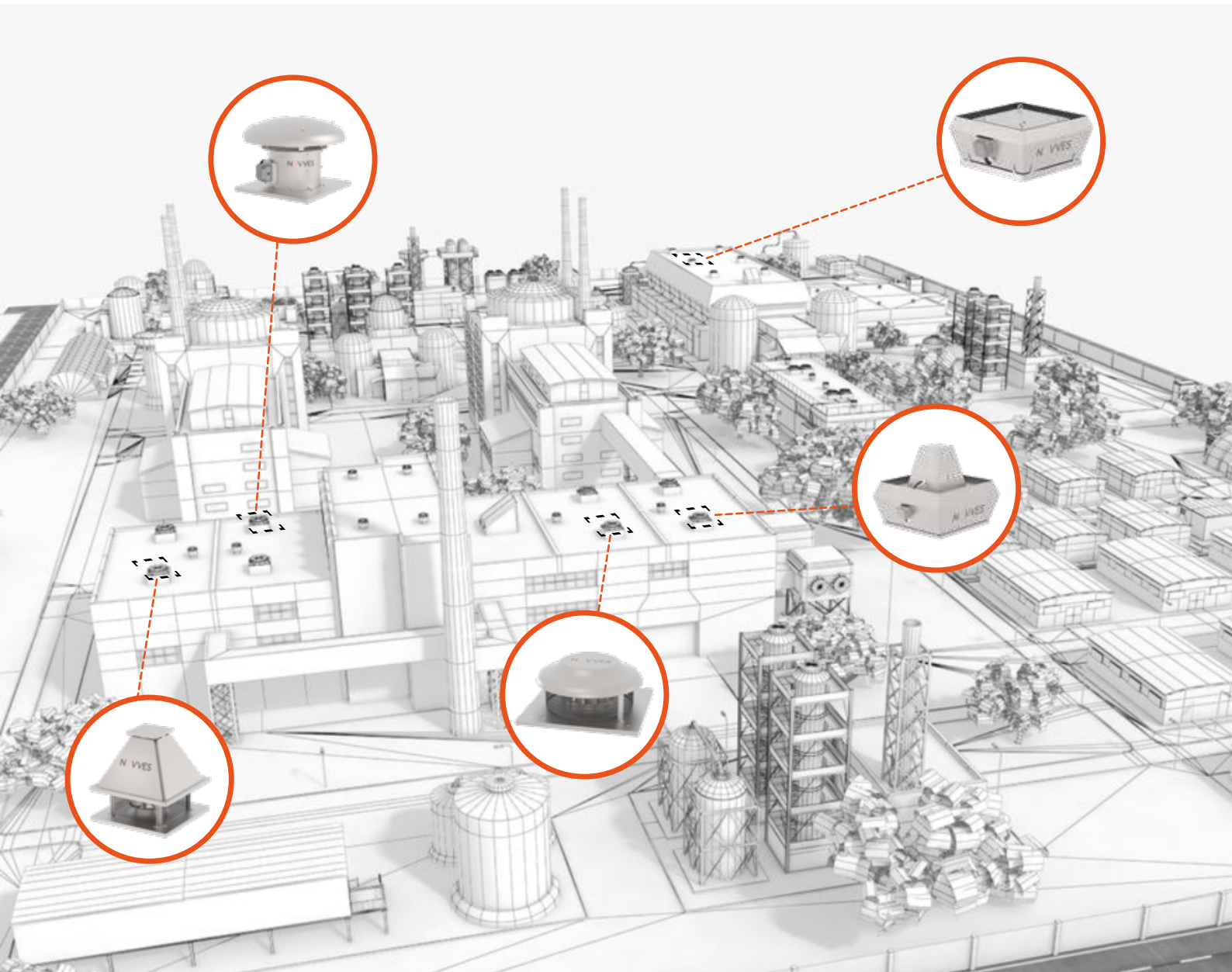



HERON SERIES

General

The Heron series, designed to be mounted on the roof in order to increase the air quality of indoor spaces, is used as an exhaust fan. Heron AH Series can also be produced as a fresh air fan upon request.

Body

The body and mounting plate of the Heron AH series are made of electrostatic powder coated steel. It can also be produced from hot-dip galvanized or epoxy powder-coated upon request. Other series are made of galvanized sheet. Coating options with epoxy paint or electrostatic powder paint are also available. RH, RHS, AH Series evacuate the air horizontally, RV, RVS Series evacuate the air vertically. The compact bodies of the series with mounting plates provide ease of mounting on vertical shafts, chimneys or roof panels in structures.

Impeller

The blades of the RH, RHS, RV, RVS model fans in the series are backward curved, sparse and aerodynamically designed and made of steel. In the design of the AH model fans, aerophilic axial blade design was used and the hub structure of the blade was made of aluminum alloy, and the blades were made of glass reinforced polypropylene. The propellers are dynamically and statically balanced in accordance with ISO 1940.

Motor

All of the RHS and RVS Models, and some of the RV and RHS Models are composed of asynchronous motors, but predominantly a closed external rotor motor. RH, RHS, RV, RVS models are suitable for high performance operation up to 40°C, and AH models up to 50°C. RHS and RVS models can be used for hot air discharge up to a maximum of 120°C due to the motor being outside the airflow.

IP CLASS

Fans of Heron RH and RV Models are in IP 44 protection, F insulation class. Heron RVS, RHS and AH Models are in IP 55 protection, F insulation class.

Control

Fans with single-phase motors can operate directly with the on/off switch, while fans with three-phase motors can operate directly with the help of the MCC panel. The speed adjustment of the models with single-phase motors is made with the speed switch, and the speed adjustment of the models with three-phase motors is made with the frequency inverter.

Fan Code

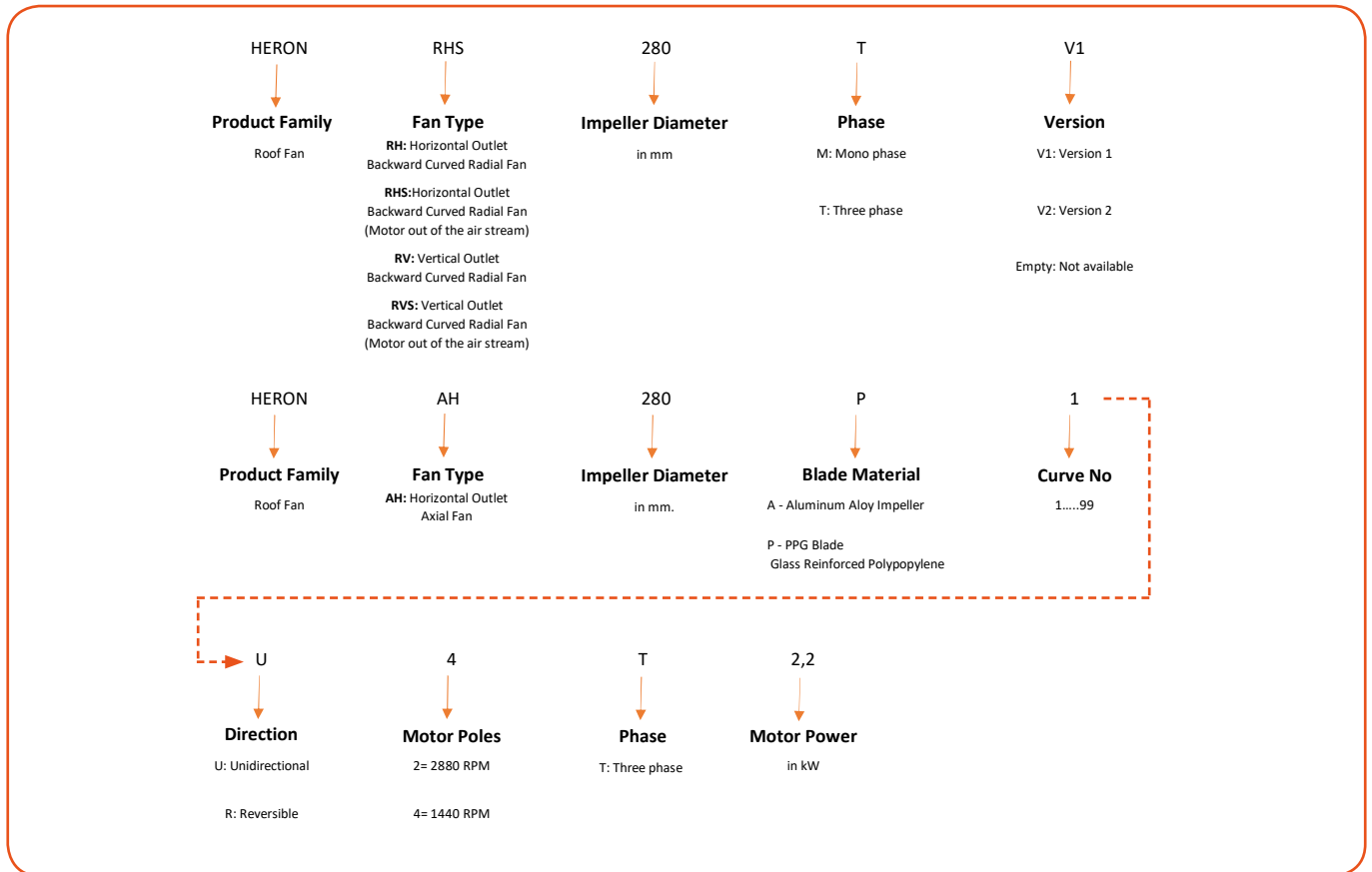

Accessories

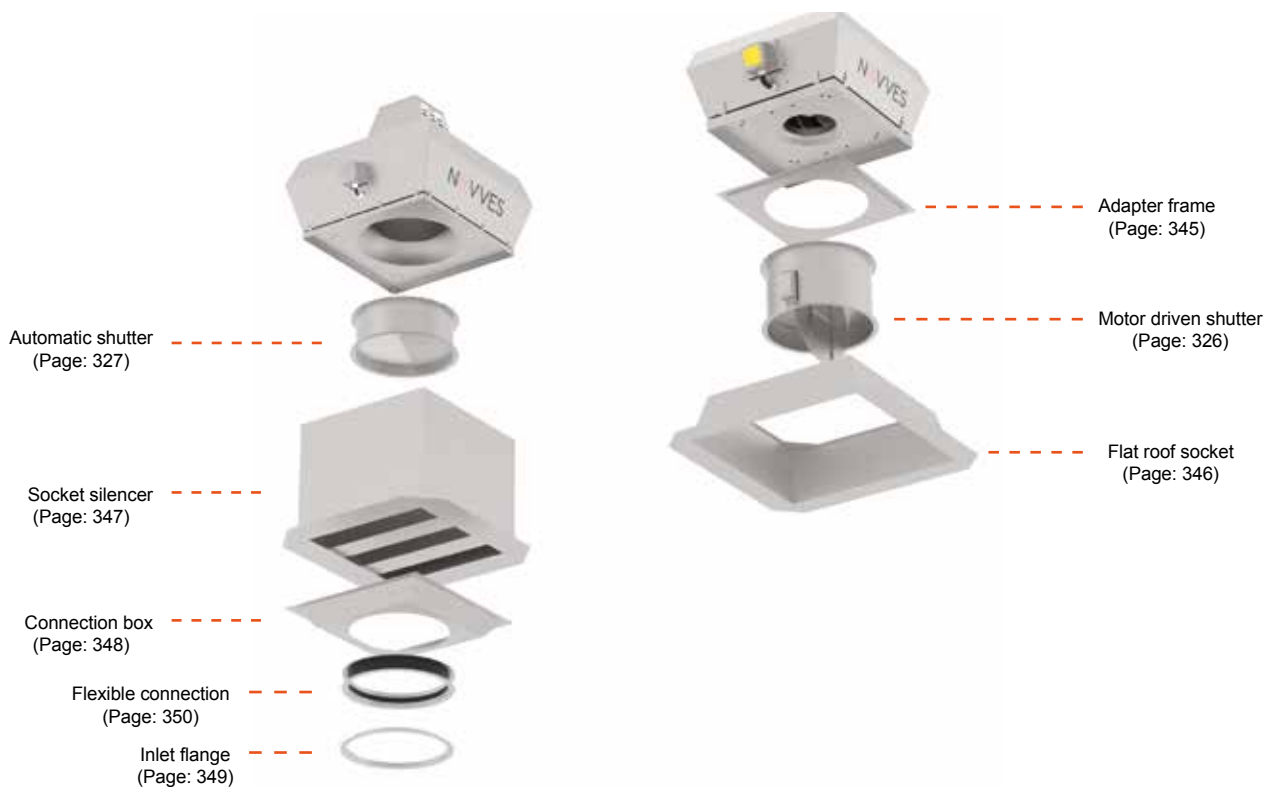

HORIZONTAL OUTLET RADIAL ROOF FANS



- Horizontal throw
- High efficiency backward curved impeller
- Suitable for aspiration
- Rotational speed can be set with speed controller and frequency inverter

HERON RH - SYSTEM CURVE

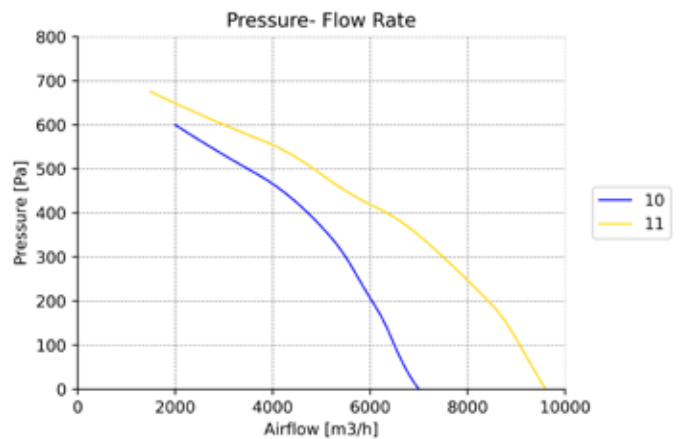
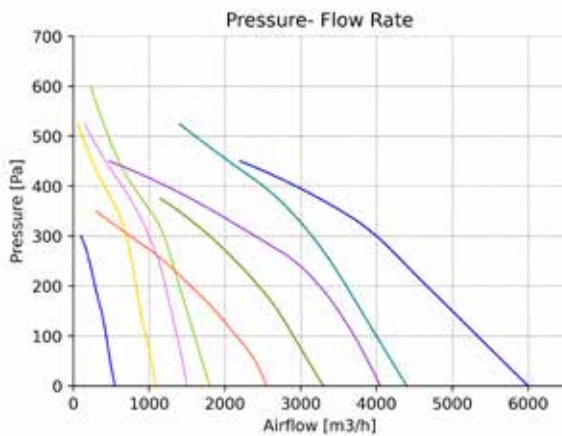

TECHNICAL PARAMETERS

MODEL	MODEL NUMBER	Voltage	Motor Power	Current	Rotation Speed	Sound Pressure	Protection Class	Working Range	Mass
		V-Hz	W	A	RPM	Lp(A) dB at 3m	IP	°C	Kg
HERON RH 190M	1	230-50	60	0,35	2700	53	44	-30/60	7
HERON RH 225M	2	230-50	135	0,6	2600	55	44	-30/60	9
HERON RH 250M	3	230-50	230	1,05	2700	57	44	-30/60	10
HERON RH 280M	4	230-50	230	1,1	2450	64	44	-30/60	13
HERON RH 355MV1	5	230-50	210	1	1400	48	54	-30/60	18
HERON RH 355MV2	6	230-50	400	2,6	1400	62	54	-30/60	19
HERON RH 400MV1	7	230-50	430	1,5	1380	54	54	-30/60	25
HERON RH 400MV2	8	230-50	510	1,5	1380	51	54	-30/60	26,5
HERON RH 450M	9	230-50	800	3,5	1350	64	54	-30/60	30
HERON RH 450T	10	400-50	1100	2,5	1400	67	54	-30/60	36
HERON RH 500T	11	400-50	1500	2,6	1400	65	54	-30/60	48

PRODUCT DIMENSIONS

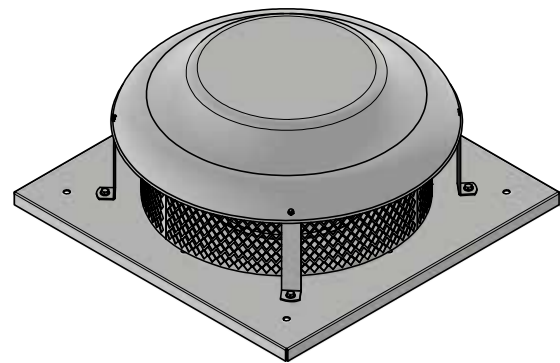
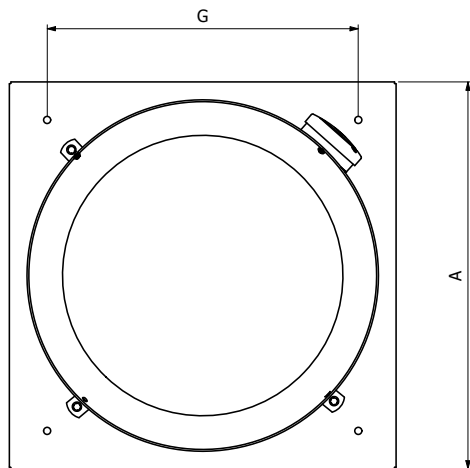
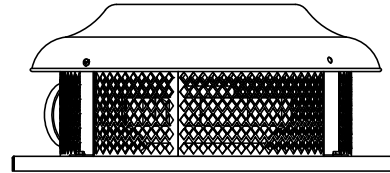
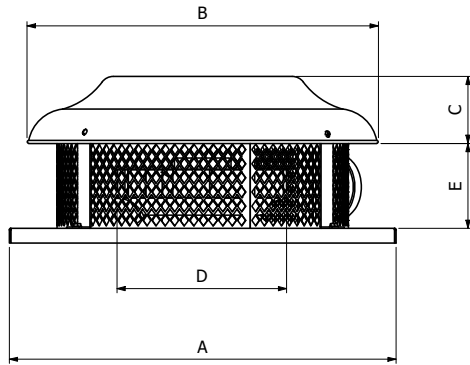

MODEL	A	B	C	Ø D	E	G
HERON RH 190M	350	330	105	110	90	290
HERON RH 225M	400	395	105	130	105	320
HERON RH 250M	450	460	110	150	120	360
HERON RH 280M	510	460	110	240	140	420
HERON RH 355MV1	595	500	80	235	180	495
HERON RH 355MV2	595	500	80	235	180	495
HERON RH 400MV1	595	530	80	270	180	495
HERON RH 400MV2	595	530	80	270	180	495
HERON RH 450M	665	530	80	285	220	565
HERON RH 450T	665	530	80	285	220	565
HERON RH 500T	800	900	100	320	265	690

HORIZONTAL OUTLET RADIAL ROOF FANS WITH EXTERNAL MOTOR



- Motor outside the air stream
- High efficiency backward curved impeller
- 120°C continuous operation
- Suitable for kitchen exhaust aspiration
- Rotational speed can be set with frequency inverter

HERON RHS - SYSTEM CURVE

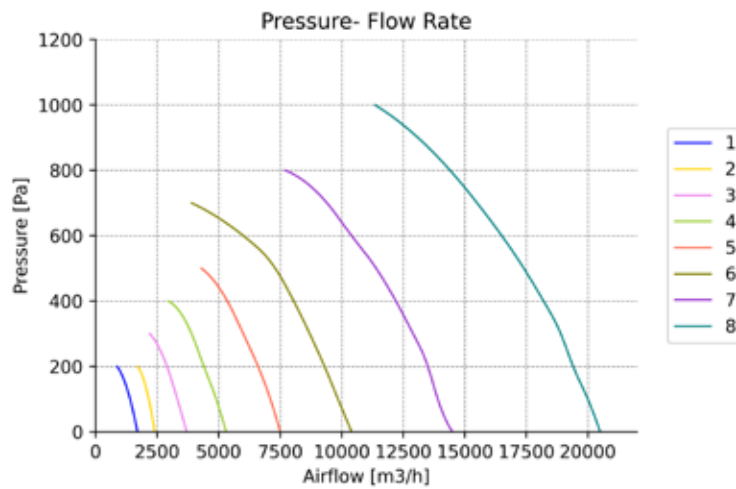

TECHNICAL PARAMETERS

MODEL	MODEL NUMBER	Voltage	Motor	Current	Rotation	Sound	Protecti-	Working	Mass
		Frequency	Power		Speed	Pressure	on Class	Range	
		V-Hz	kW	A	RPM	Lp(A) dB at 3m	IP	°C	Kg
HERON RHS 280T	1	400-50	0,25	0,27	1450	50	55	-25/60	57
HERON RHS 315T	2	400-50	0,25	0,8	1450	53	55	-25/60	65
HERON RHS 355T	3	400-50	0,37	1,2	1450	57	55	-25/60	68
HERON RHS 400T	4	400-50	0,55	2,1	1450	60	55	-25/60	74
HERON RHS 450T	5	400-50	1,1	3,6	1450	62	55	-25/60	92
HERON RHS 500T	6	400-50	1,5	5,3	1450	63	55	-25/60	102
HERON RHS 560T	7	400-50	3	8,7	1450	66	55	-25/60	138
HERON RHS 630T	8	400-50	5,5	11,8	1450	68	55	-25/60	171

PRODUCT DIMENSIONS

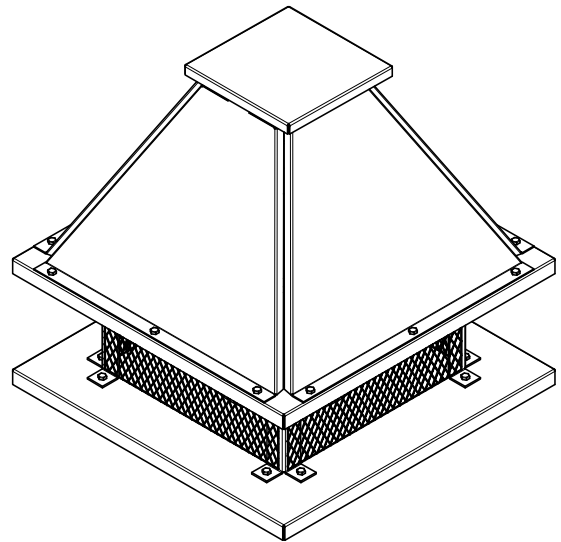
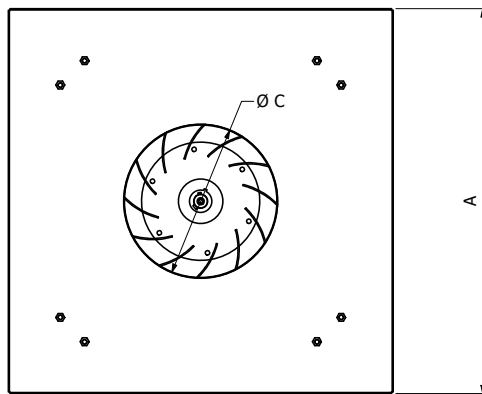
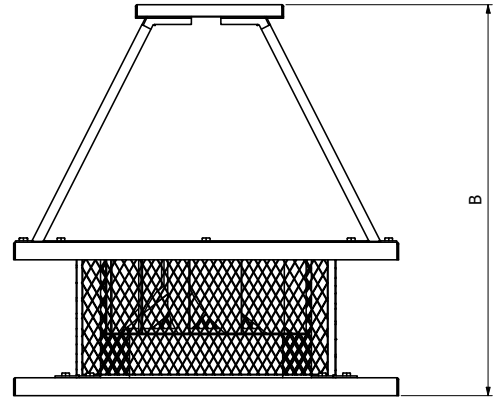
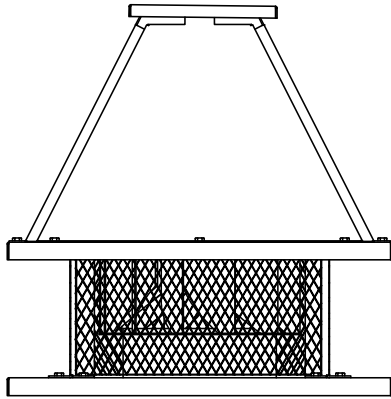

MODEL	A	B	ØC
HERON RHS 280T	500	500	190
HERON RHS 315T	550	550	205
HERON RHS 355T	600	600	230
HERON RHS 400T	650	650	250
HERON RHS 450T	700	650	280
HERON RHS 500T	700	650	320
HERON RHS 560T	800	700	360
HERON RHS 630T	850	700	410

VERTICAL OUTLET RADIAL ROOF FANS



- High efficiency backward curved impeller
- Suitable for aspiration
- Rotational speed can be set with speed controller and frequency inverter

HERON RV - SYSTEM CURVE

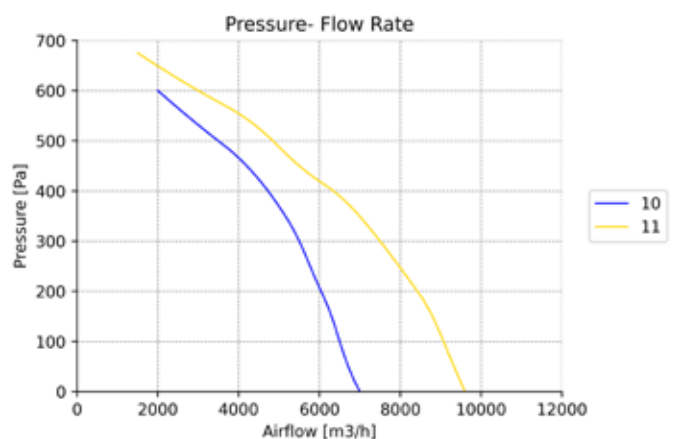
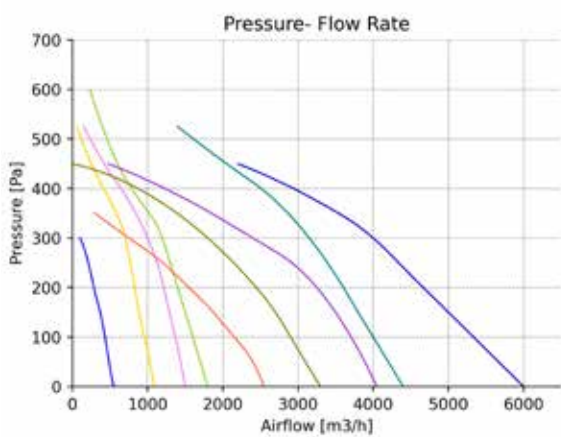

TECHNICAL PARAMETERS

MODEL	MODEL NUMBER	Voltage Frequency	Motor Power	Current	Rotation Speed	Sound Pressure	Protection Class	Working Range	Mass
		V-Hz	W	A	RPM	Lp(A) dB at 3m	IP	°C	Kg
HERON RV 190M	1	230-50	60	0,35	2700	53	55	-30/60	10
HERON RV 225M	2	230-50	135	0,6	2600	55	55	-30/60	15
HERON RV 250M	3	230-50	230	1,05	2700	57	55	-30/60	21
HERON RV 280M	4	230-50	230	1,1	2450	64	55	-30/60	25
HERON RV 355MV1	5	230-50	210	1	1400	48	55	-30/60	32
HERON RV 355MV2	6	230-50	400	2,6	1400	62	55	-30/60	33
HERON RV 400MV1	7	230-50	430	1,5	1380	54	55	-30/60	37
HERON RV 400MV2	8	230-50	510	1,5	1380	51	55	-30/60	38
HERON RV 450M	9	230-50	800	3,5	1350	64	55	-30/60	43
HERON RV 450T	10	400-50	1100	2,5	1400	67	55	-30/60	45
HERON RV 500T	11	400-50	1500	2,6	1400	65	55	-30/60	52

PRODUCT DIMENSIONS

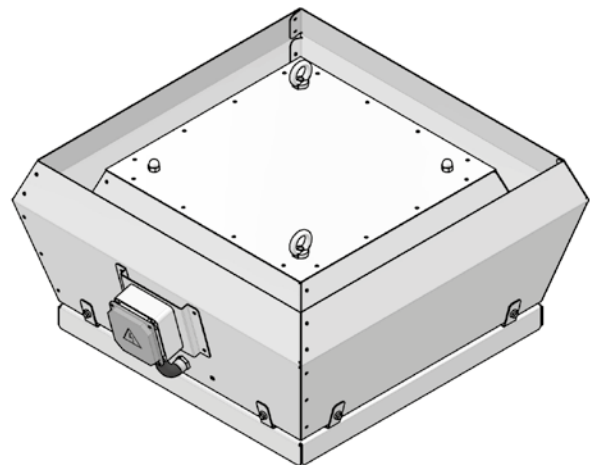
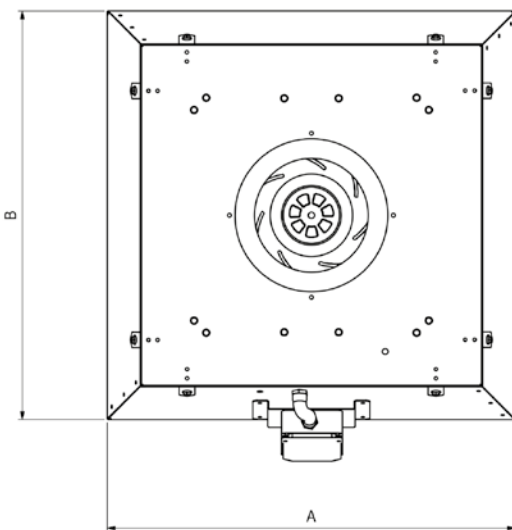
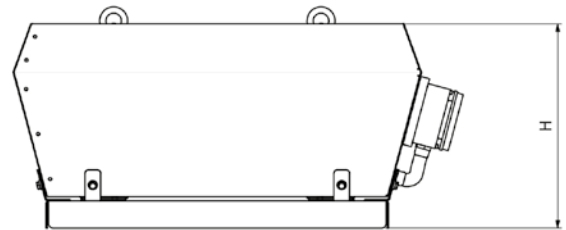
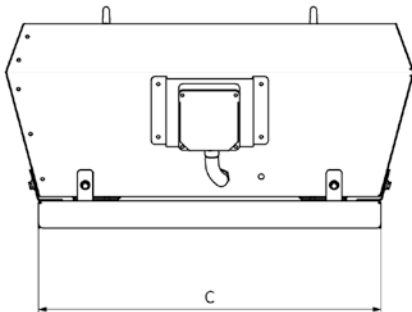

MODEL	A	B	C	H	Ø
HERON RV 190M	410	410	350	190	190
HERON RV 225M	525	525	440	265	225
HERON RV 250M	525	525	440	265	250
HERON RV 280M	615	615	500	342	280
HERON RV 355MV1	635	635	570	350	355
HERON RV 355MV2	635	635	570	350	355
HERON RV 400MV1	722	722	610	360	400
HERON RV 400MV2	722	722	610	360	400
HERON RV 450M	855	918	722	500	450
HERON RV 450T	875	938	735	459	450
HERON RV 500T	945	1006	794	498	500

VERTICAL OUTLET RADIAL ROOF FANS WITH EXTERNAL MOTOR



- Vertical Throw
- Motor outside the air stream
- 120°C continuous operation
- Backward curved impeller
- Suitable for kitchen exhaust aspiration
- Rotational speed can be set with frequency inverter

HERON RVS - SYSTEM CURVE

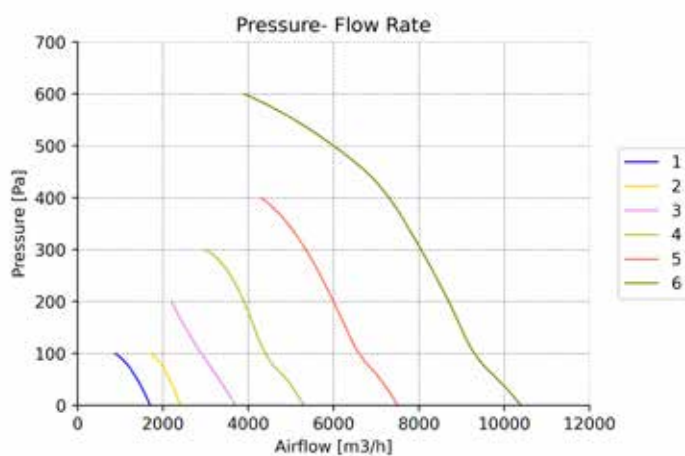

MODEL	MODEL NUMBER	Voltage Frequency	Motor Power	Current	Rotation Speed	Sound Pressure	Protection Class	Working Range	Mass
		V-Hz	kW	A	RPM	Lp(A) dB at 3m	IP	°C	Kg
HERON RVS 280T	1	400-50	0,25	0,27	1450	50	55	-25/60	64
HERON RVS 315T	2	400-50	0,25	0,8	1450	53	55	-25/60	72
HERON RVS 355T	3	400-50	0,37	1,2	1450	57	55	-25/60	75
HERON RVS 400T	4	400-50	0,55	2,1	1450	68	55	-25/60	81
HERON RVS 450T	5	400-50	1,1	3,6	1450	72	55	-25/60	99
HERON RVS 500T	6	400-50	1,5	5,3	1450	65	55	-25/60	109

PRODUCT DIMENSIONS

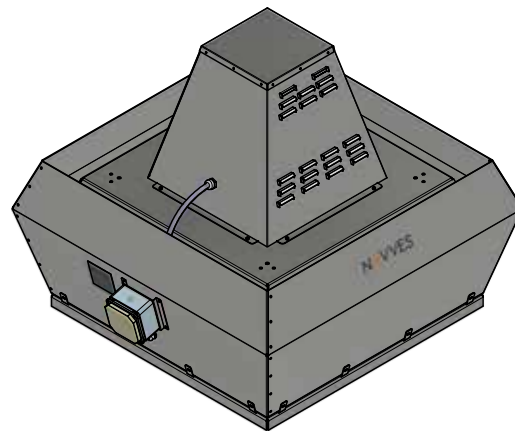
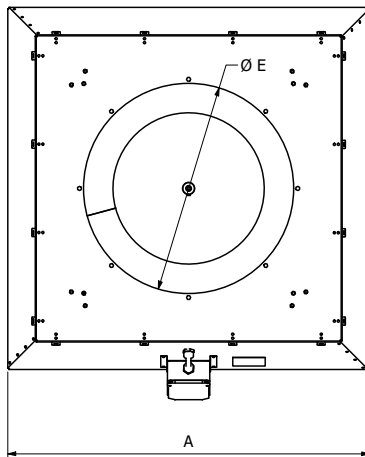
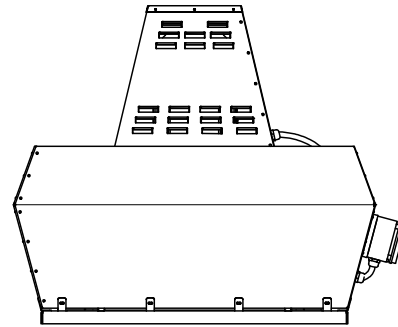
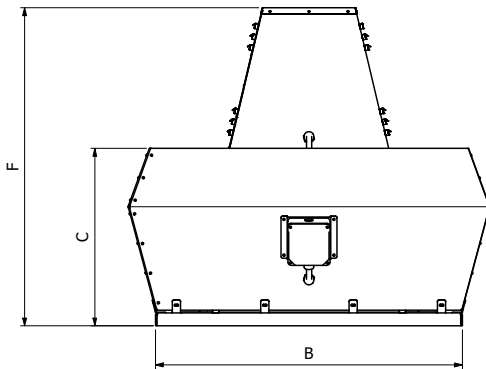

MODEL	A	B	C	D	ØE	F
HERON RVS 280T	480	380	215	350	190	380
HERON RVS 315T	560	450	340	510	207	470
HERON RVS 355T	750	610	365	600	233	510
HERON RVS 400T	750	610	415	600	256	565
HERON RVS 450T	900	750	465	670	287	630
HERON RVS 500T	930	780	455	700	320	660



HORIZONTAL AXIAL ROOF FANS



- Horizontal throw
- Rotational speed can be set with speed controller and frequency inverter
- Double speed motor option
- Adjustable propeller angle
- Can be used for fresh air supply or air exhaust up to 50°C

HERON AH - SYSTEM CURVE - 2 POLES

Ø400 / 3-4-5 Blade

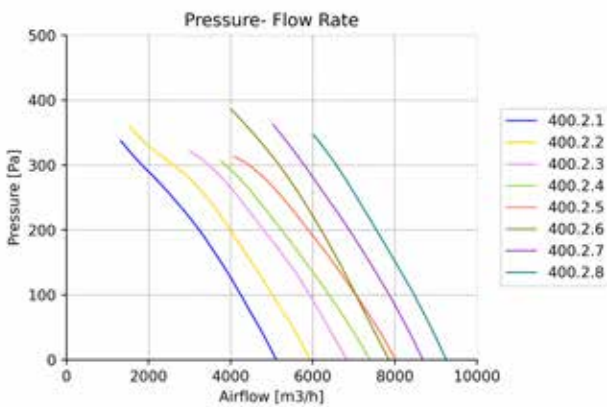

Ø400 / 6-8-10 Blade

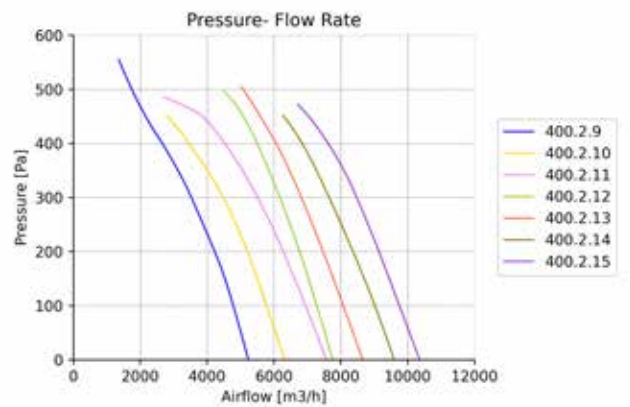

Ø450 / 3-4-6 Blade

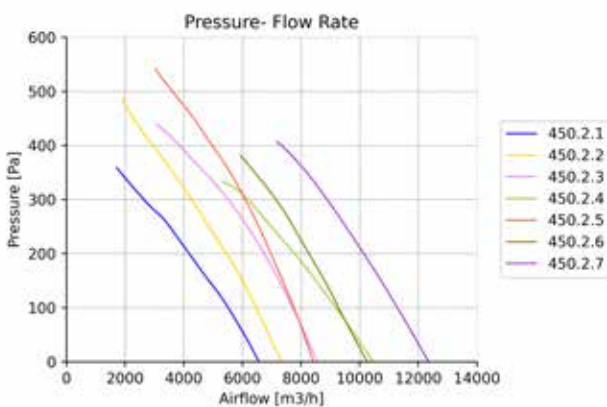

Ø450 / 5-6-8 Blade

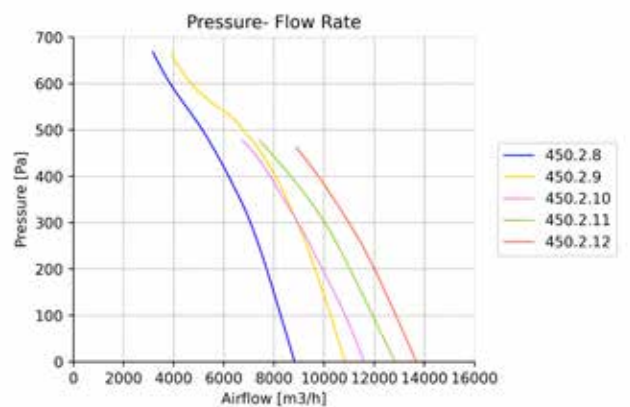

HERON AH - SYSTEM CURVE - 2 POLES

Ø450 / 10 Blade

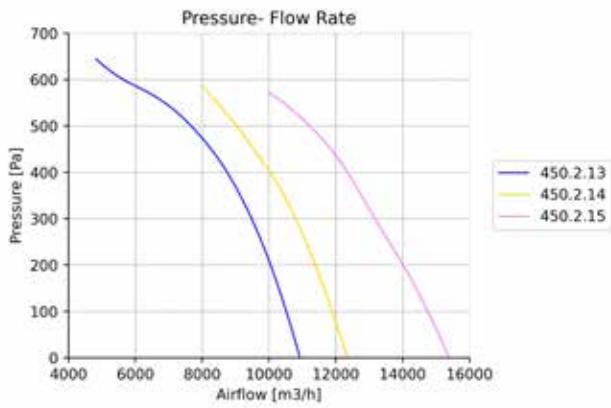

Ø500 / 3-4 Blade

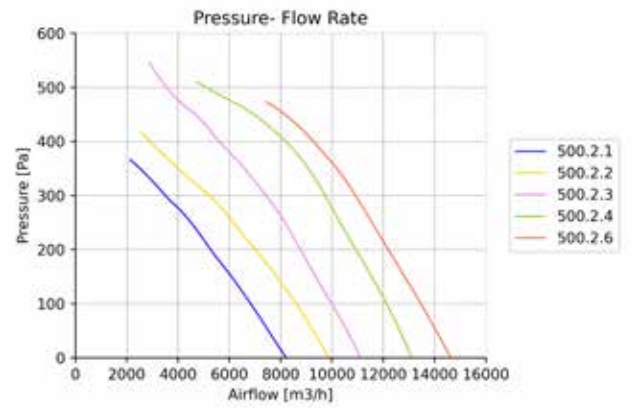

Ø500 / 5 Blade

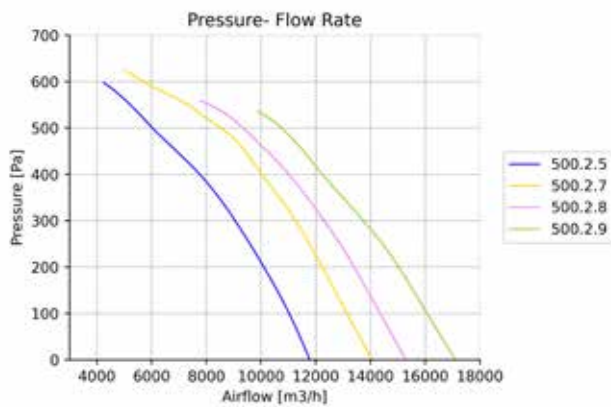

Ø500 / 10 Blade

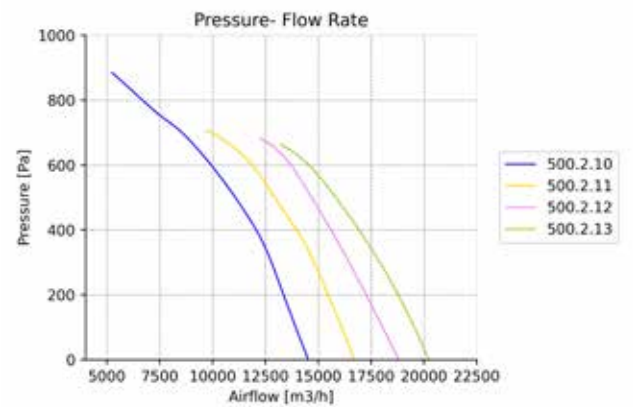

Ø560 / 3-4-5 Blade

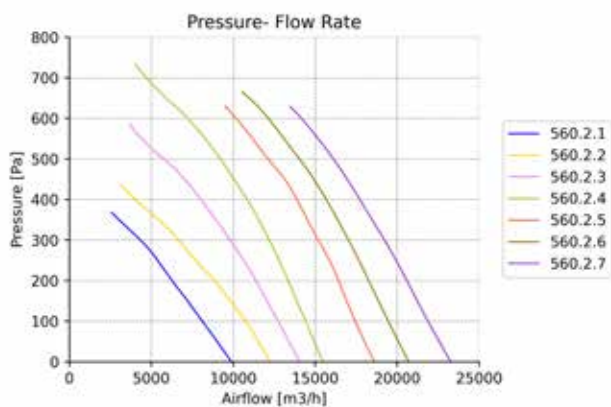

Ø560 / 6 Blade

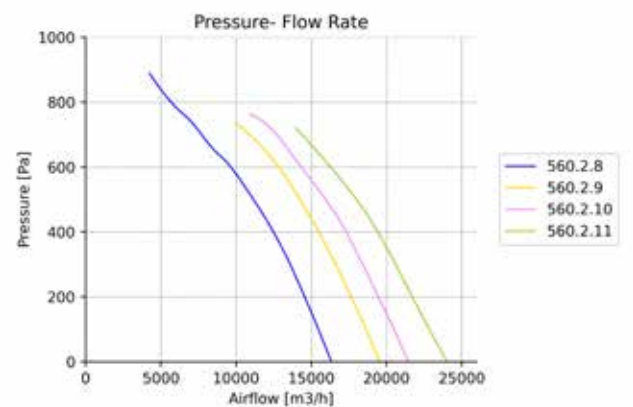

HERON AH - SYSTEM CURVE - 2 POLES

Ø560 / 10 Blade

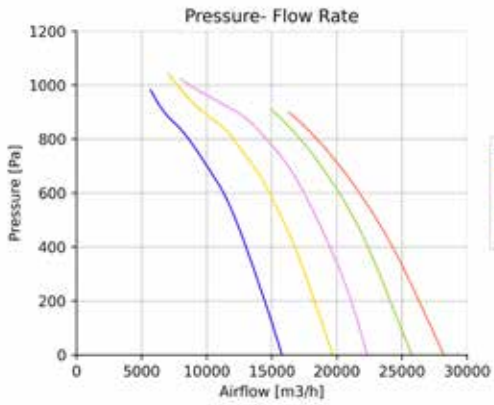

Ø630 / 3-4-5-6 Blade

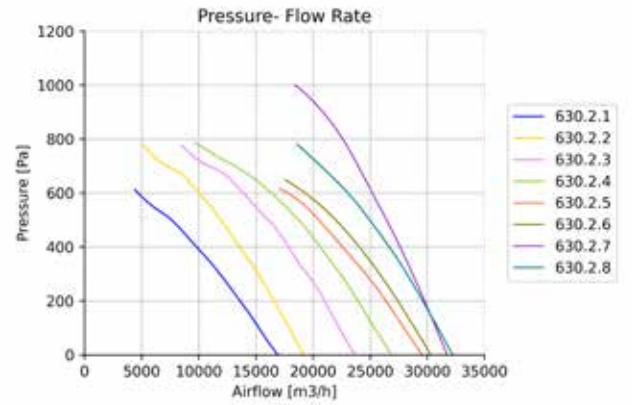

Ø630 / 6-10-12 Blade

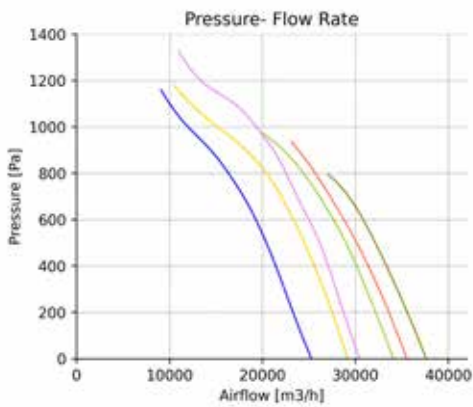

Ø710 / 3-6 Blade

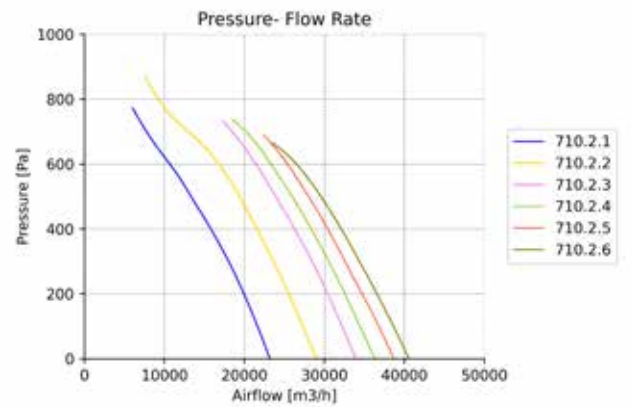

Ø710 / 6-12 Blade

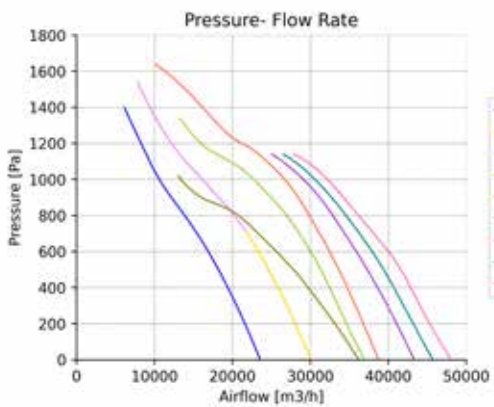

Ø800 / 3-6 Blade

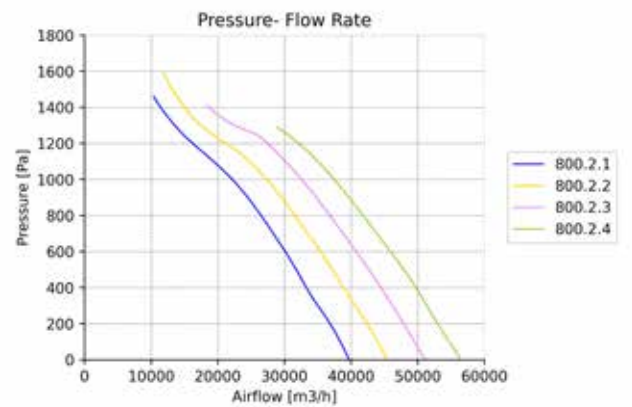

HERON AH - SYSTEM CURVE - 2 POLES

Ø800 / 6-6 Blade

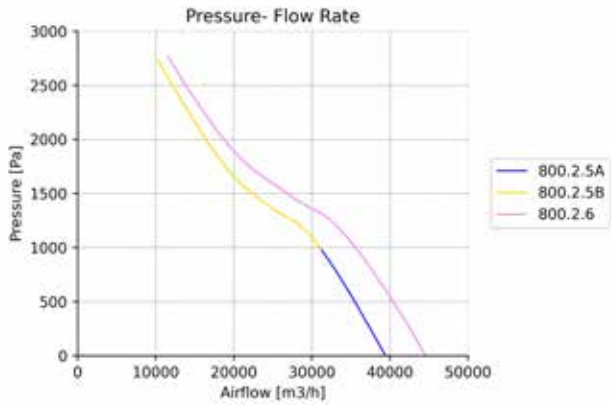

HERON AH - SYSTEM CURVE - 4 POLES

Ø400 / 6-8 Blade

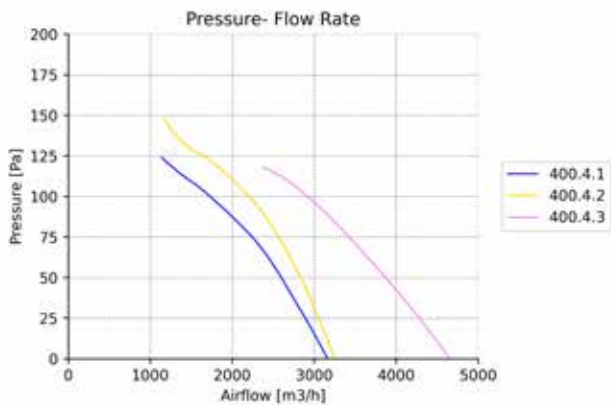

Ø450 / 6-8-10 Blade

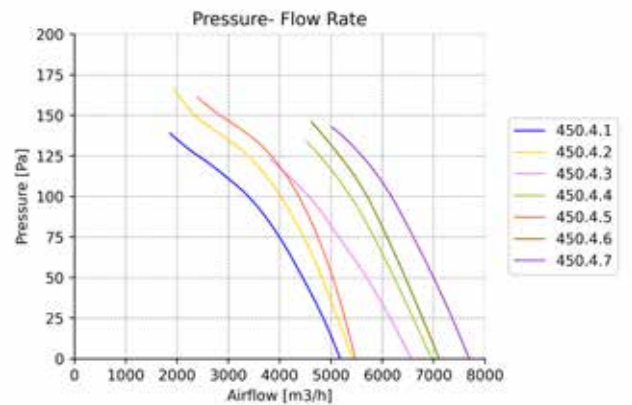

Ø500 / 6-8-10-12 Blade

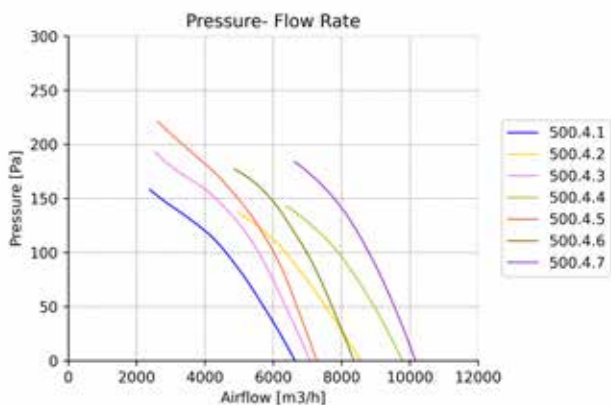

Ø560 / 3-4-6-8 Blade

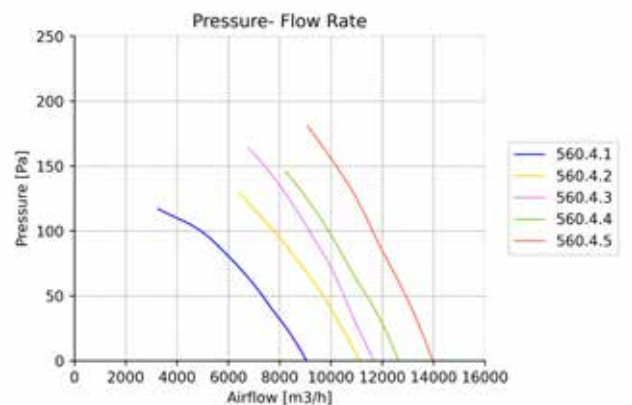

HERON AH - SYSTEM CURVE - 4 POLES

Ø560 / 10-12 Blade

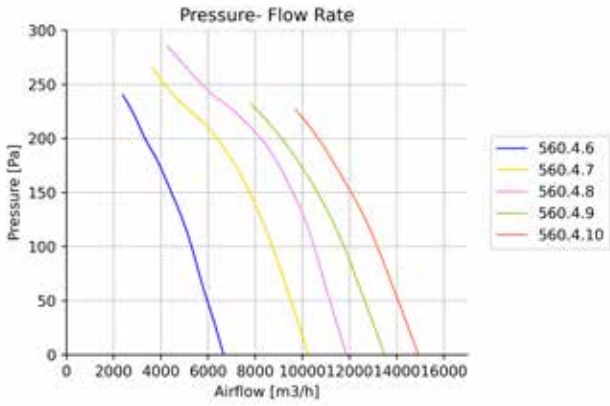

Ø630 / 5-6-8 Blade

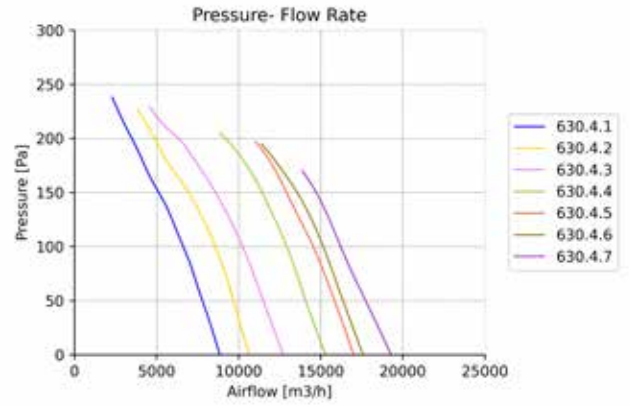

Ø630 / 10-12 Blade

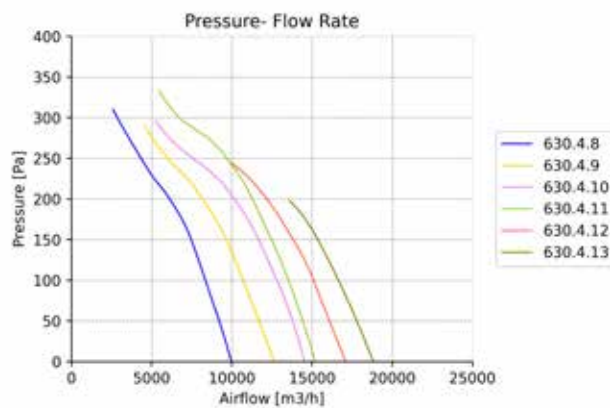

Ø630 / 9-12 Blade

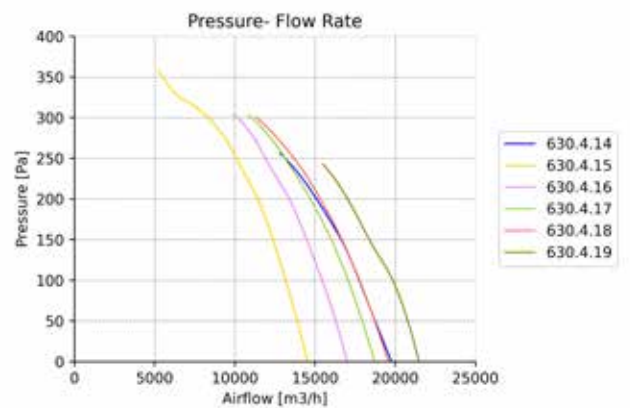

Ø710 / 5-6 Blade

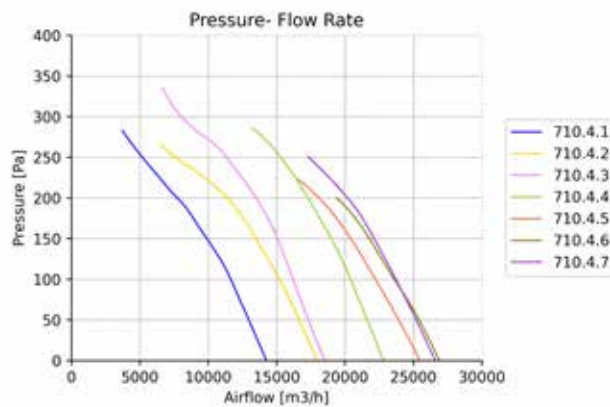

Ø710 / 9-12 Blade

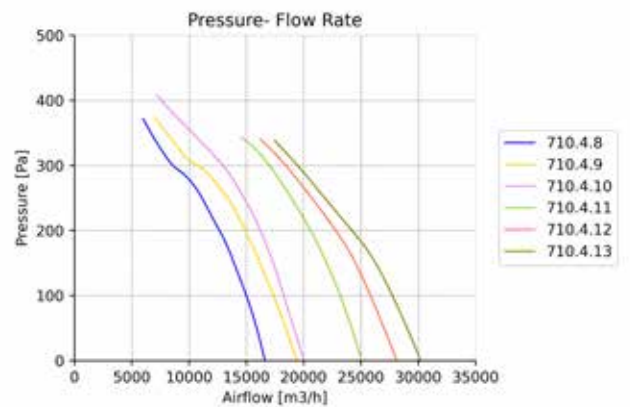

HERON AH - SYSTEM CURVE - 4 POLES

Ø800 / 6 Blade

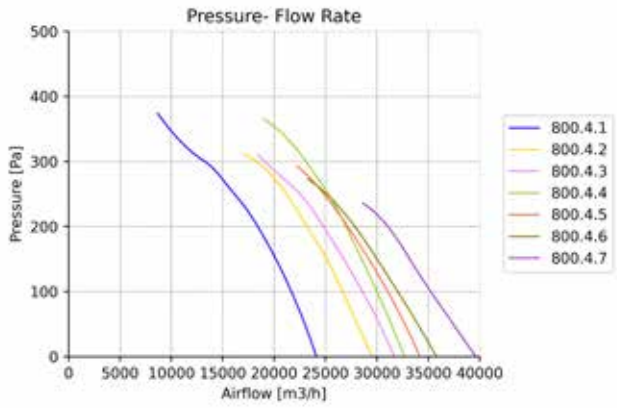

Ø800 / 8 Blade

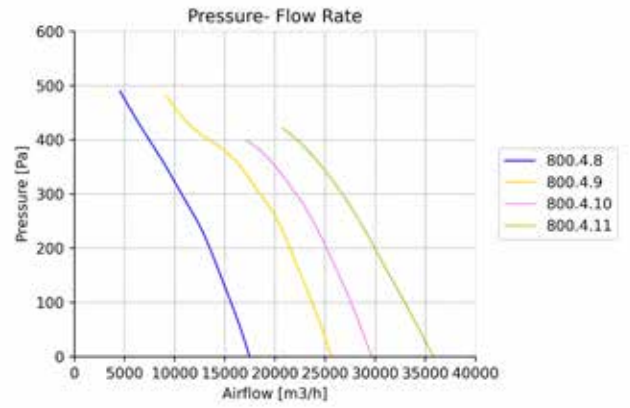

Ø800 / 9-12 Blade

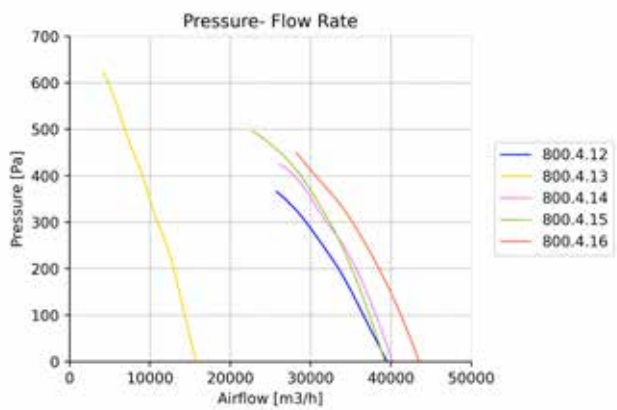

Ø800 / 6 Blade

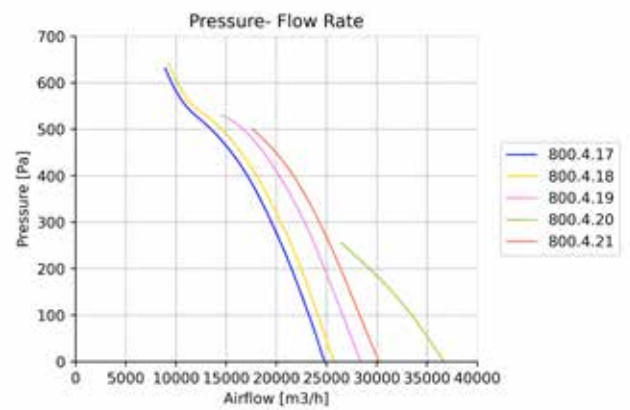

Ø900 / 6 Blade

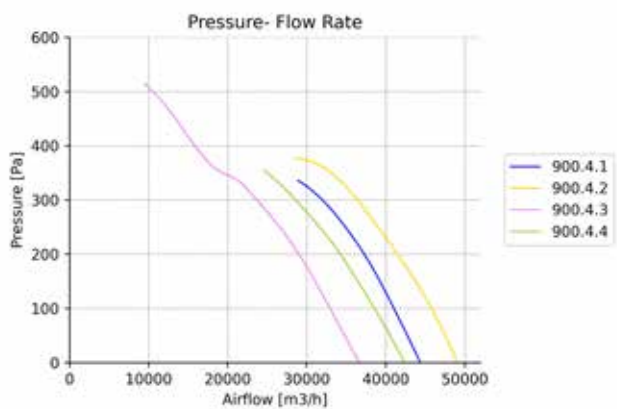

Ø900 / 8 Blade

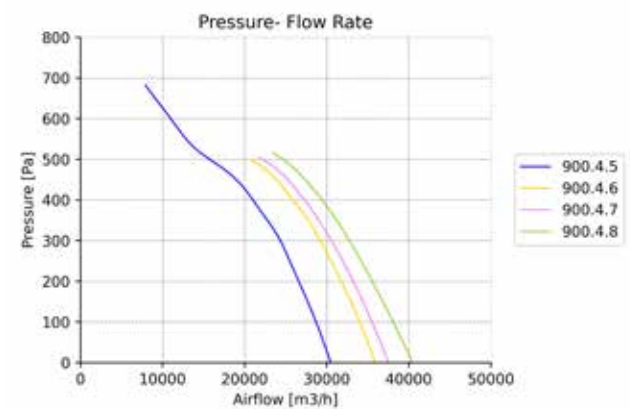

HERON AH - SYSTEM CURVE - 4 POLES

Ø900 / 9 Blade

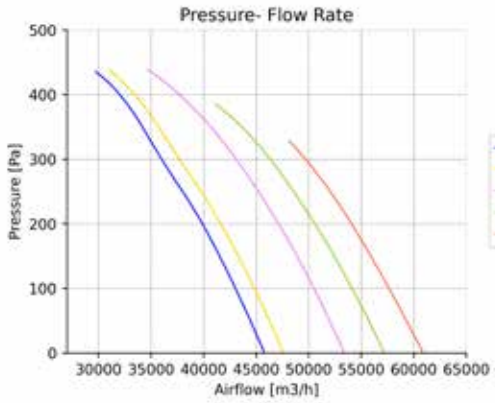

Ø900 / 12 Blade

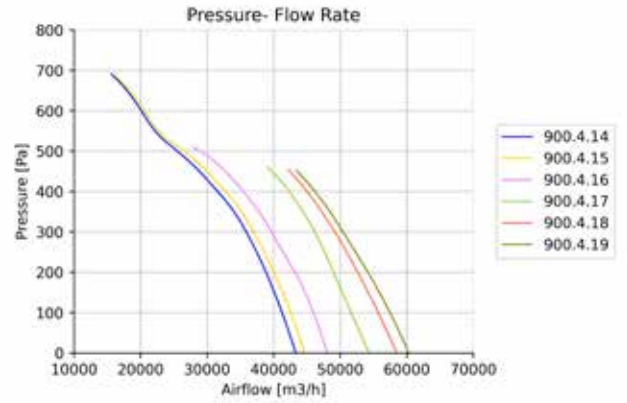

Ø900 / 6 Blade

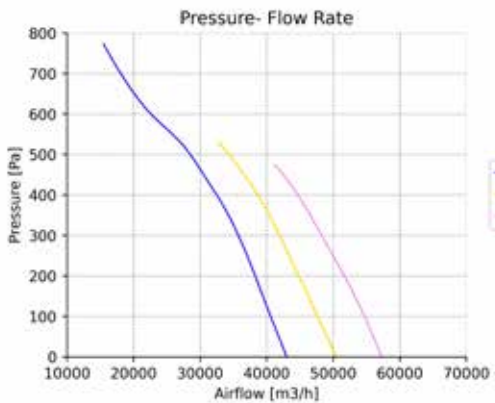

Ø1000 / 3 Blade

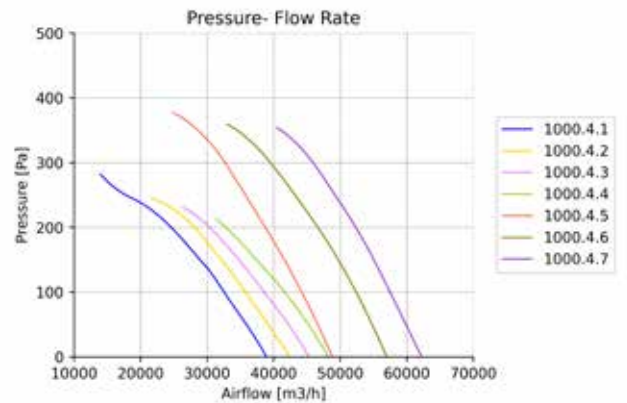

Ø1000 / 5-6 Blade

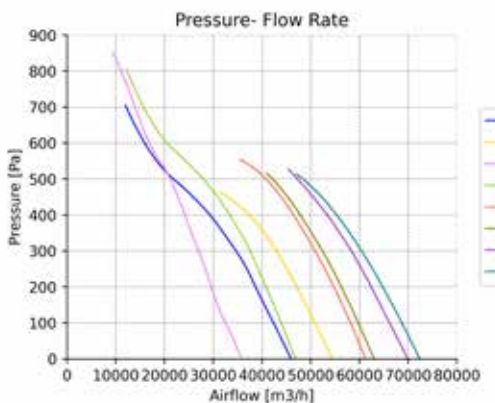

Ø1000 / 6 Blade

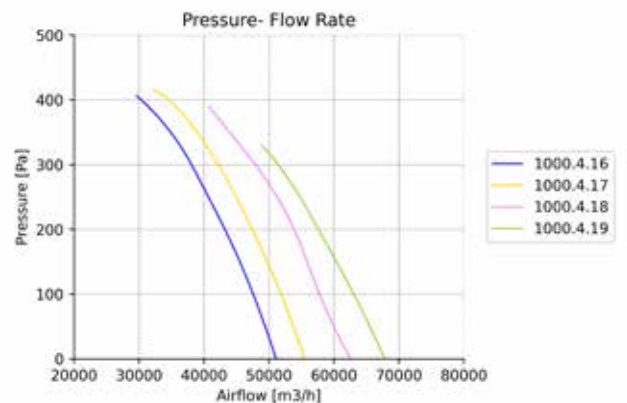

HERON AH - SYSTEM CURVE - 4 POLES

Ø1000 / 6 Blade

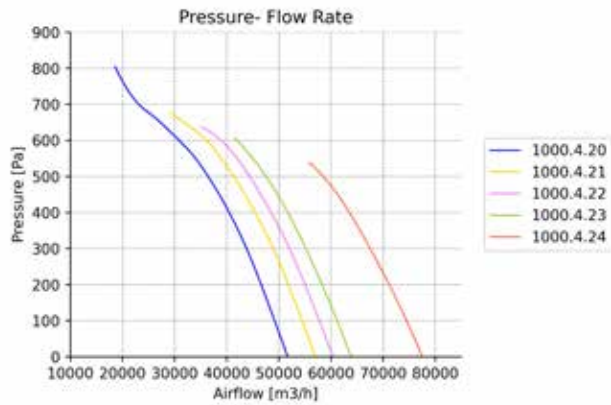

Ø1000 / 8 Blade

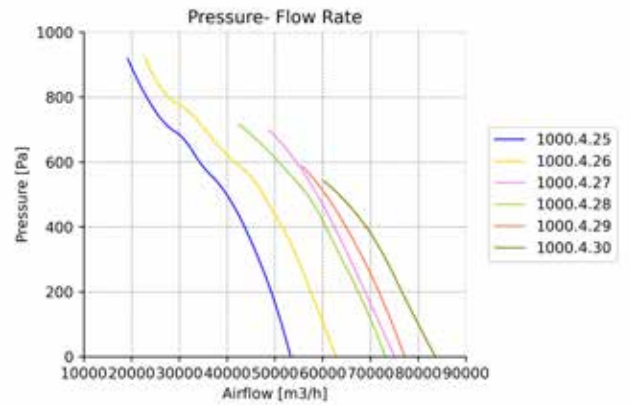

Ø1000 / 9 Blade

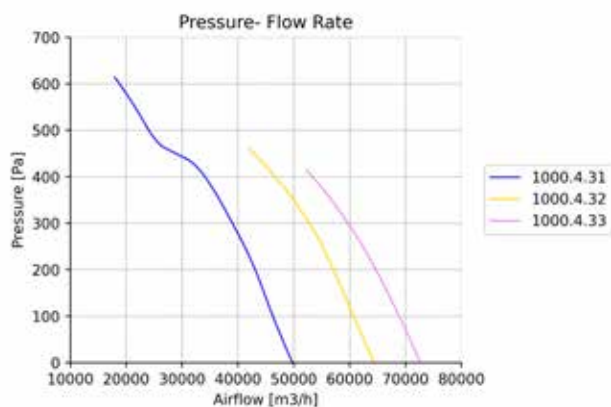

Ø1000 / 10 Blade

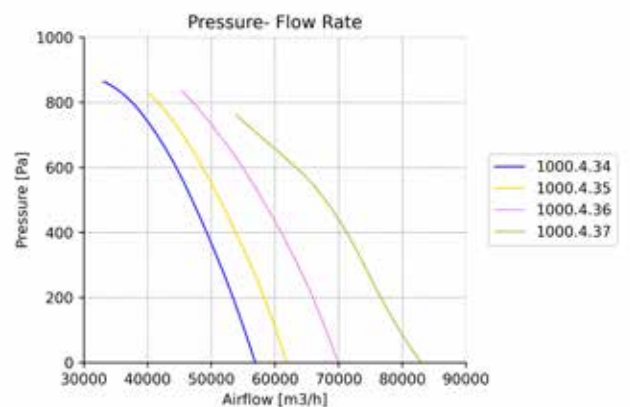

Ø1120 / 3 Blade

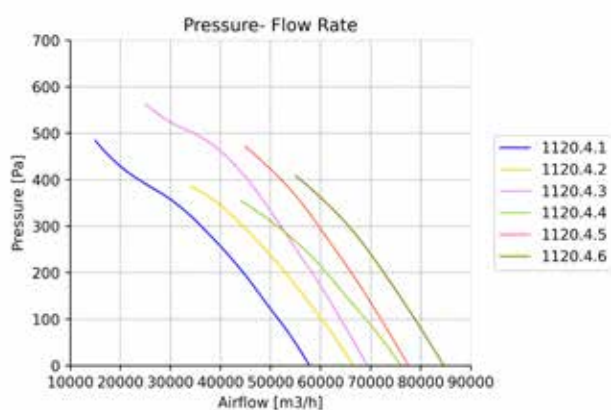

Ø1120 / 6 Blade

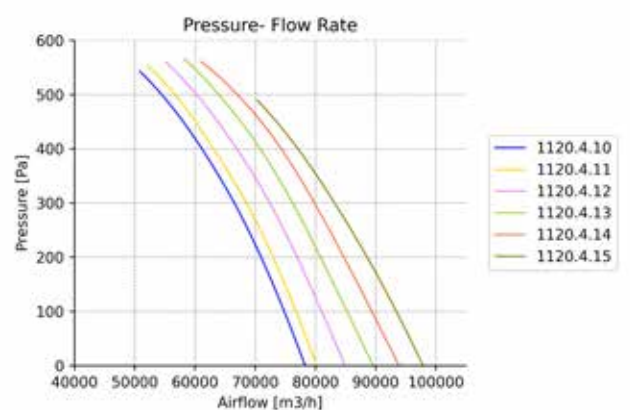

HERON AH - SYSTEM CURVE - 4 POLES

Ø1120 / 6 Blade

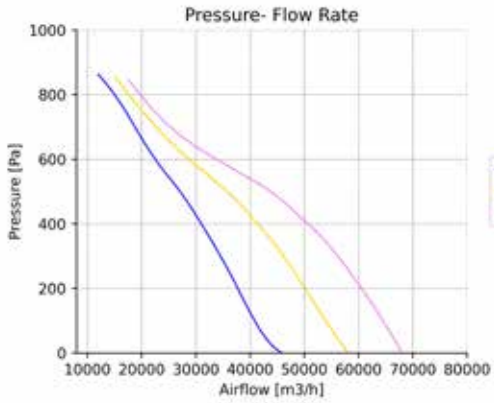

Ø1120 / 6 Blade

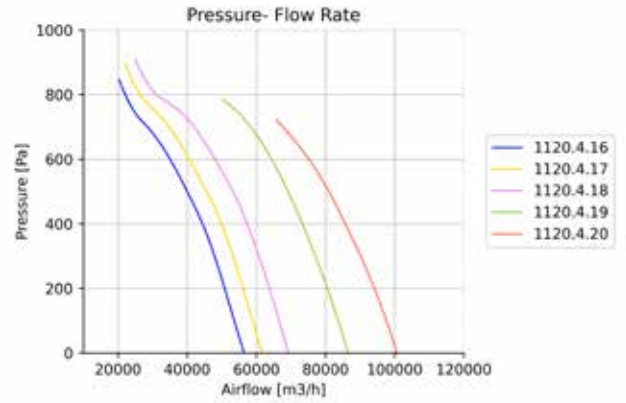

Ø1120 / 8 Blade

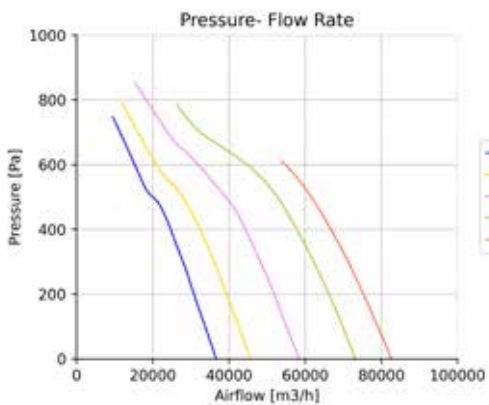

Ø1120 / 8 Blade

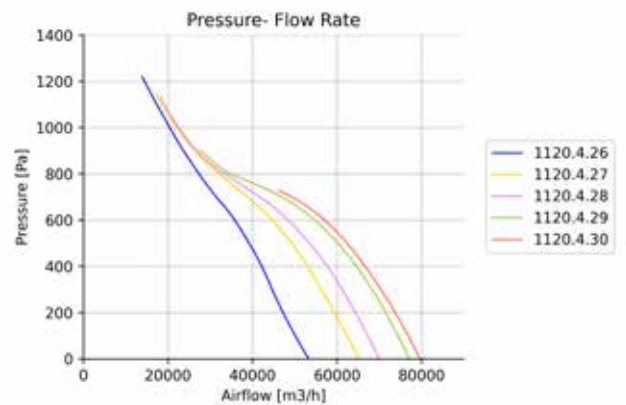

Ø1120 / 8 Blade

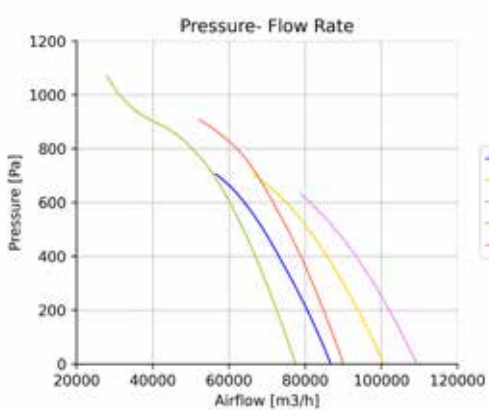

Ø1120 / 10-12 Blade

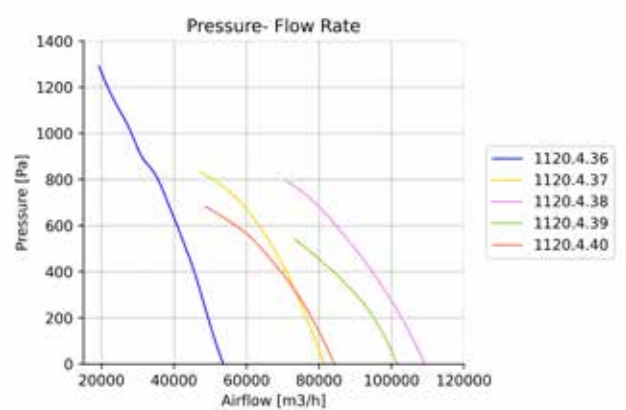

HERON AH - SYSTEM CURVE - 4 POLES

Ø1250 / 3 Blade

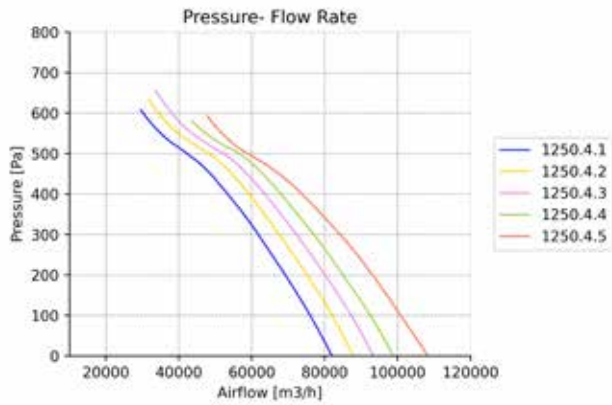

Ø1250 / 6 Blade

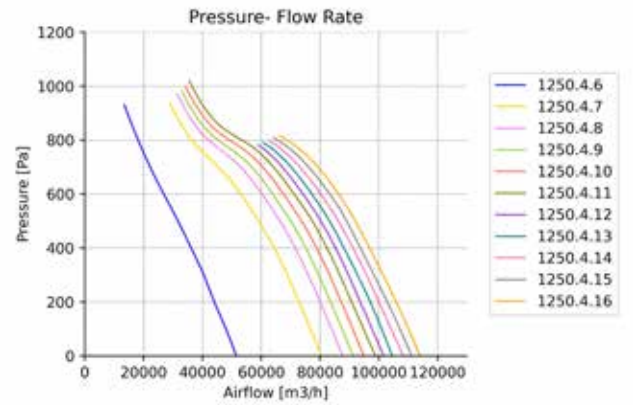

Ø1250 / 6 Blade

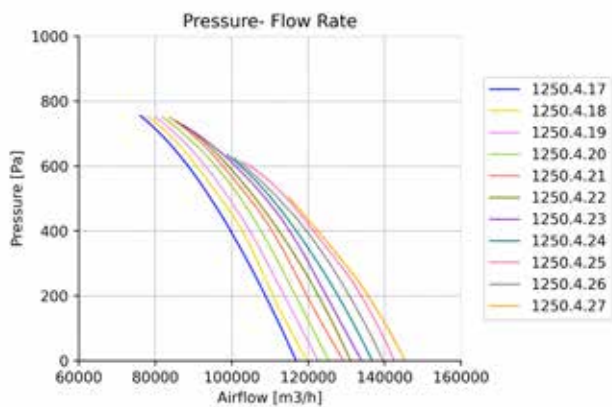

Ø1250 / 8 Blade

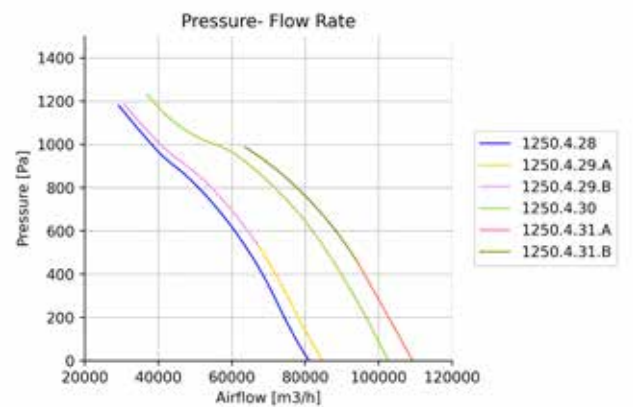

Ø1250 / 8 Blade

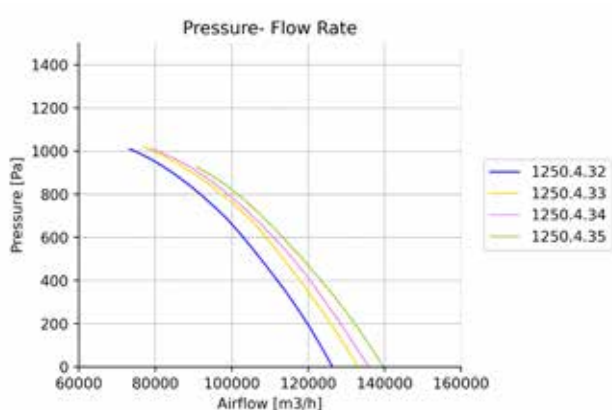

Ø1250 / 5 Blade

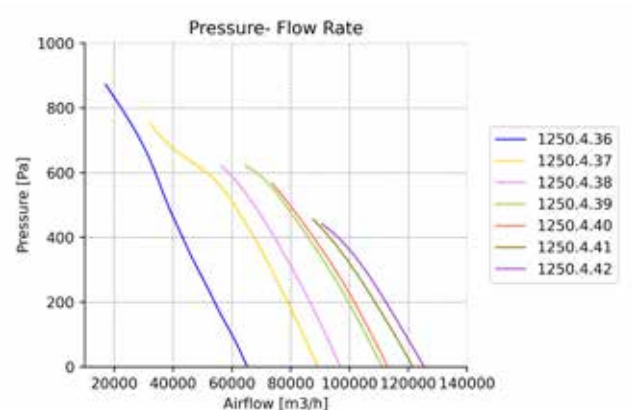

PRODUCT DIMENSIONS

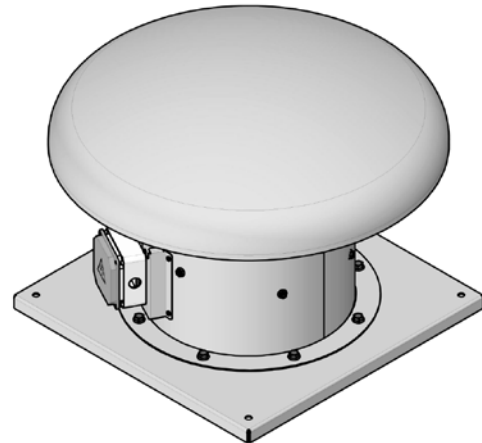
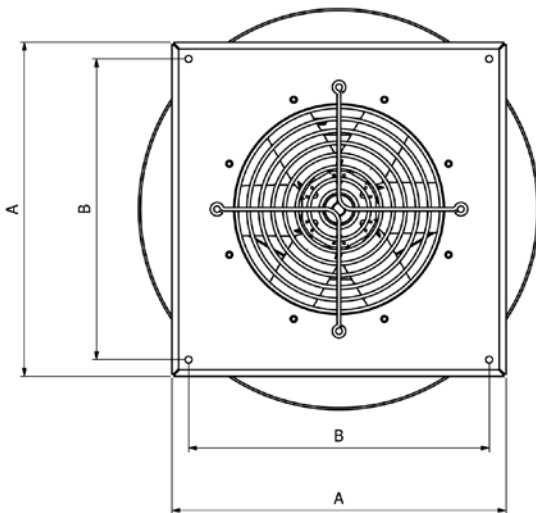
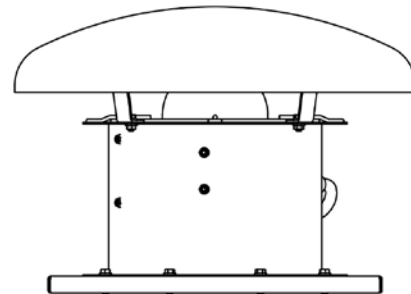
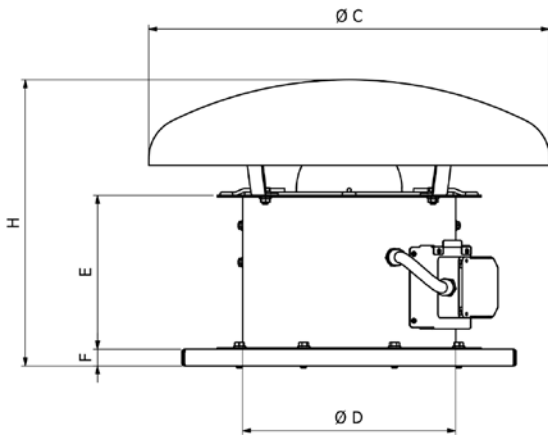

MODEL	MOTOR FRAME SIZE	A	B	C	ØD	E	F	H
HERON AH 400	63/71/80/90	650	600	600	400	230	25	430
HERON AH 450	63/71/80/90/110/112	650	600	900	450	250	30	550
HERON AH 500	63/71/80/90/110/112	750	700	900	500	250	30	550
HERON AH 560	71/80/90/110/112/132	750	700	900	560	300	30	550
HERON AH 630	71/80/90/110/112/132	1000	940	1200	630	350	40	660
HERON AH 630	160	1000	940	1200	630	550	40	860
HERON AH 710	80/90/110/112/132	1000	940	1200	710	350	40	660
HERON AH 710	160	1000	940	1200	710	550	40	860
HERON AH 800	80/90/110/112/132	1100	1000	1500	800	350	50	810
HERON AH 800	160	1100	1000	1500	800	550	50	1010
HERON AH 900	80/90/110/112/132	1300	1200	1500	900	350	50	810
HERON AH 900	160/180	1300	1200	1500	900	550	50	1010
HERON AH 1000	80/90/110/112/132	1300	1200	1500	1000	350	50	810
HERON AH 1000	160/180/200/225	1300	1200	1500	1000	550	50	1010

Over size which is not listed above, please check your representative to get technical information.

TECHNICAL PARAMETERS

MODEL	MODEL NUMBER	Voltage Frequency	Motor Power	Current	Rotation Speed	Sound Pressure	Protection Class	Working Range	Mass
		V-Hz	kW	A	RPM	Lp(A) dB at 3m	IP	°C	~ Kg
HERON AH 400P1U-2T0,37	400.2.1	400-50	0,37	1,5	2880	70,5	55	-20/+50	32
HERON AH 400P2U-2T0,55	400.2.2	400-50	0,55	1,6	2880	68,5	55	-20/+50	33
HERON AH 400P3U-2T0,75	400.2.3	400-50	0,75	1,7	2880	69,8	55	-20/+50	35
HERON AH 400P4U-2T0,75	400.2.4	400-50	0,75	1,7	2880	70,6	55	-20/+50	35
HERON AH 400P5U-2T1,1	400.2.5	400-50	1,1	2,3	2880	73,2	55	-20/+50	39
HERON AH 400P6U-2T1,1	400.2.6	400-50	1,1	2,3	2880	70,5	55	-20/+50	39
HERON AH 400P7U-2T1,5	400.2.7	400-50	1,5	3,3	2880	73	55	-20/+50	41
HERON AH 400P8U-2T2,2	400.2.8	400-50	2,2	4,5	2880	75,4	55	-20/+50	43
HERON AH 400P9U-2T0,75	400.2.9	400-50	0,75	1,7	2880	73,6	55	-20/+50	34
HERON AH 400P10U-2T0,75	400.2.10	400-50	0,75	1,7	2880	71,6	55	-20/+50	34
HERON AH 400P11U-2T1,1	400.2.11	400-50	1,1	2,3	2880	70,2	55	-20/+50	39
HERON AH 400P12U-2T1,5	400.2.12	400-50	1,5	3,3	2880	71,4	55	-20/+50	41
HERON AH 400P13U-2T1,5	400.2.13	400-50	1,5	3,3	2880	71,2	55	-20/+50	41
HERON AH 400P14U-2T2,2	400.2.14	400-50	2,2	4,5	2880	71,5	55	-20/+50	44
HERON AH 400P15U-2T3	400.2.15	400-50	3	5,9	2880	74,3	55	-20/+50	50
HERON AH 450P1U-2T0,55	450.2.1	400-50	0,55	1,6	2880	74	55	-20/+50	40
HERON AH 450P2U-2T0,75	450.2.2	400-50	0,75	1,7	2880	77,9	55	-20/+50	41
HERON AH 450P3U-2T1,1	450.2.3	400-50	1,1	2,3	2880	72,9	55	-20/+50	48
HERON AH 450P4U-2T1,1	450.2.4	400-50	1,1	2,3	2880	74,3	55	-20/+50	48
HERON AH 450P5U-2T1,1	450.2.5	400-50	1,1	2,3	2880	78	55	-20/+50	48
HERON AH 450P6U-2T1,5	450.2.6	400-50	1,5	3,3	2880	72,3	55	-20/+50	51
HERON AH 450P7U-2T2,2	450.2.7	400-50	2,2	4,5	2880	75,4	55	-20/+50	51
HERON AH 450P8U-2T1,5	450.2.8	400-50	1,5	3,3	2880	77,3	55	-20/+50	50
HERON AH 450P9U-2T2,2	450.2.9	400-50	2,2	4,5	2880	75,6	55	-20/+50	51
HERON AH 450P10U-2T2,2	450.2.10	400-50	2,2	4,5	2880	74,9	55	-20/+50	51
HERON AH 450P11U-2T3	450.2.11	400-50	3	5,9	2880	76	55	-20/+50	58
HERON AH 450P12U-2T4	450.2.12	400-50	4	7,9	2880	79,2	55	-20/+50	60
HERON AH 450P13U-2T3	450.2.13	400-50	3	5,9	2880	74,4	55	-20/+50	57
HERON AH 450P14U-2T3	450.2.14	400-50	3	5,9	2880	74,4	55	-20/+50	57
HERON AH 450P15U-2T5,5	450.2.15	400-50	5,5	10,3	2880	75,7	55	-20/+50	75
HERON AH 500P1U-2T0,75	500.2.1	400-50	0,75	1,7	2880	81,3	55	-20/+50	37
HERON AH 500P2U-2T1,1	500.2.2	400-50	1,1	2,3	2880	75,8	55	-20/+50	41
HERON AH 500P3U-2T1,5	500.2.3	400-50	1,5	3,3	2880	77,2	55	-20/+50	43
HERON AH 500P4U-2T2,2	500.2.4	400-50	2,2	4,5	2880	75,4	55	-20/+50	46
HERON AH 500P5U-2T2,2	500.2.6	400-50	2,2	4,5	2880	74,9	55	-20/+50	46
HERON AH 500P6U-2T2,2	500.2.5	400-50	2,2	4,5	2880	71,8	55	-20/+50	45
HERON AH 500P7U-2T3	500.2.7	400-50	3	5,9	2880	75,4	55	-20/+50	52
HERON AH 500P8U-2T3	500.2.8	400-50	3	5,9	2880	79	55	-20/+50	52
HERON AH 500P9U-2T4	500.2.9	400-50	4	7,9	2880	79,5	55	-20/+50	55
HERON AH 500P10U-2T4	500.2.10	400-50	4	7,9	2880	77,2	55	-20/+50	54
HERON AH 500P11U-2T5,5	500.2.11	400-50	5,5	10,3	2880	76,9	55	-20/+50	70
HERON AH 500P12U-2T7,5	500.2.12	400-50	7,5	13,6	2880	77,7	55	-20/+50	77
HERON AH 500P13U-2T7,5	500.2.13	400-50	7,5	13,6	2880	77,7	55	-20/+50	77
HERON AH 560P1U-2T0,75	560.2.1	400-50	0,75	1,7	2880	77,7	55	-20/+50	60

MODEL	MODEL NUMBER	Voltage Frequency	Motor Power	Current	Rotation Speed	Sound Pressure	Protection Class	Working Range	Mass
		V-Hz	kW	A	RPM	Lp(A) dB at 3m	IP	°C	~ Kg
HERON AH 560P2U-2T1,1	560.2.2	400-50	1,1	2,3	2880	75,4	55	-20/+50	61
HERON AH 560P3U-2T1,5	560.2.3	400-50	1,5	3,3	2880	78,7	55	-20/+50	64
HERON AH 560P4U-2T2,2	560.2.4	400-50	3	5,9	2880	79	55	-20/+50	65
HERON AH 560P5U-2T4	560.2.5	400-50	4	7,9	2880	77,7	55	-20/+50	76
HERON AH 560P6U-2T4	560.2.6	400-50	4	7,9	2880	78,8	55	-20/+50	76
HERON AH 560P7U-2T5,5	560.2.7	400-50	5,5	10,3	2880	80,6	55	-20/+50	92
HERON AH 560P8U-2T3	560.2.8	400-50	3	5,9	2880	77,7	55	-20/+50	72
HERON AH 560P9U-2T4	560.2.9	400-50	4	7,9	2880	78,2	55	-20/+50	76
HERON AH 560P10U-2T5,5	560.2.10	400-50	5,5	10,3	2880	78,5	55	-20/+50	91
HERON AH 560P11U-2T7,5	560.2.11	400-50	7,5	13,6	2880	80,3	55	-20/+50	98
HERON AH 560P12U-2T4	560.2.12	400-50	4	7,9	2880	79,3	55	-20/+50	76
HERON AH 560P13U-2T5,5	560.2.13	400-50	5,5	10,3	2880	80,7	55	-20/+50	91
HERON AH 560P14U-2T7,5	560.2.14	400-50	7,5	13,6	2880	79,4	55	-20/+50	98
HERON AH 560P15U-2T11	560.2.15	400-50	11	19,5	2880	80,1	55	-20/+50	126
HERON AH 560P16U-2T11	560.2.16	400-50	11	19,5	2880	79,8	55	-20/+50	126
HERON AH 630P1U-2T2,2	630.2.1	400-50	2,2	4,5	2880	78,7	55	-20/+50	81
HERON AH 630P2U-2T3	630.2.2	400-50	3	5,9	2880	79,8	55	-20/+50	88
HERON AH 630P3U-2T5,5	630.2.3	400-50	5,5	10,3	2880	78,2	55	-20/+50	107
HERON AH 630P4U-2T5,5	630.2.4	400-50	5,5	10,3	2880	80,3	55	-20/+50	107
HERON AH 630P5U-2T7,5	630.2.5	400-50	7,5	13,6	2880	83,5	55	-20/+50	114
HERON AH 630P6U-2T7,5	630.2.6	400-50	7,5	13,6	2880	81,4	55	-20/+50	114
HERON AH 630P7U-2T11	630.2.7	400-50	11	19,5	2880	83,7	55	-20/+50	143
HERON AH 630P8U-2T11	630.2.8	400-50	11	19,5	2880	81,7	55	-20/+50	143
HERON AH 630P9U-2T7,5	630.2.9	400-50	7,5	13,6	2880	83,4	55	-20/+50	114
HERON AH 630P10U-2T11	630.2.10	400-50	11	19,5	2880	81,6	55	-20/+50	143
HERON AH 630P11U-2T11	630.2.11	400-50	11	19,5	2880	81,7	55	-20/+50	142
HERON AH 630P12U-2T15	630.2.12	400-50	15	28,3	2880	81,6	55	-20/+50	157
HERON AH 630P13U-2T15	630.2.13	400-50	15	28,3	2880	83,7	55	-20/+50	157
HERON AH 630P14U-2T15	630.2.14	400-50	15	28,3	2880	81,5	55	-20/+50	157
HERON AH 710P1U-2T3	710.2.1	400-50	3	5,9	2880	84,8	55	-20/+50	91
HERON AH 710P2U-2T5,5	710.2.2	400-50	5,5	10,3	2880	82	55	-20/+50	112
HERON AH 710P3U-2T7,5	710.2.3	400-50	7,5	13,6	2880	82,3	55	-20/+50	119
HERON AH 710P4U-2T7,5	710.2.4	400-50	7,5	13,6	2880	83,1	55	-20/+50	119
HERON AH 710P5U-2T11	710.2.5	400-50	11	19,5	2880	83,9	55	-20/+50	142
HERON AH 710P6U-2T11	710.2.6	400-50	11	19,5	2880	84,9	55	-20/+50	142
HERON AH 710P7U-2T5,5	710.2.7	400-50	5,5	10,3	2880	92,5	55	-20/+50	106
HERON AH 710P8.AU-2T7,5	710.2.8A	400-50	7,5	13,6	2880	88,5	55	-20/+50	118
HERON AH 710P8.BU-2T11	710.2.8B	400-50	11	19,5	2880	88,5	55	-20/+50	141
HERON AH 710P9U-2T15	710.2.9	400-50	15	28,3	2880	81,4	55	-20/+50	160
HERON AH 710P10U-2T11	710.2.10	400-50	11	19,5	2880	86,5	55	-20/+50	141
HERON AH 710P11U-2T15	710.2.11	400-50	15	28,3	2880	83,3	55	-20/+50	158
HERON AH 710P12U-2T15	710.2.12	400-50	15	28,3	2880	86,5	55	-20/+50	160
HERON AH 710P13U-2T18,5	710.2.13	400-50	18,5	32,3	2880	87,5	55	-20/+50	182
HERON AH 710P14U-2T18,5	710.2.14	400-50	18,5	32,3	2880	87,5	55	-20/+50	182
HERON AH 800P1U-2T11	800.2.1	400-50	11	19,5	2880	87,5	55	-20/+50	141
HERON AH 800P2U-2T15	800.2.2	400-50	15	28,3	2880	88,5	55	-20/+50	155
HERON AH 800P3U-2T18,5	800.2.3	400-50	18,5	32,3	2880	90,5	55	-20/+50	177

HERON AH 800P4U-2T22	800.2.4	400-50	22	38,3	2880	91,5	55	-20/+50	214
HERON AH 800P5U-2T18,5	800.2.5	400-50	18,5	32,3	2880	91,5	55	-20/+50	187
HERON AH 800P6U-2T18,5	800.2.6	400-50	18,5	32,3	2880	91,5	55	-20/+50	187
HERON AH 800P7U-2T22	800.2.7	400-50	22	38,3	2880	91,5	55	-20/+50	219

MODEL	MODEL NUMBER	Voltage Frequency	Motor Power	Current	Rotation Speed	Sound Pressure	Protection Class	Working Range	Mass
		V-Hz	kW	A	RPM	Lp(A) dB at 3m	IP	°C	~ Kg
HERON AH 400P1U-4T0,37	400.4.1	400-50	0,37	1,13	1440	56,5	55	-20/+50	34
HERON AH 400P2U-4T0,37	400.4.2	400-50	0,37	1,13	1440	56,7	55	-20/+50	34
HERON AH 400P3U-4T0,37	400.4.3	400-50	0,37	1,13	1440	57,6	55	-20/+50	34
HERON AH 450P1U-4T0,37	450.4.1	400-50	0,37	1,13	1440	58,7	55	-20/+50	41
HERON AH 450P2U-4T0,37	450.4.2	400-50	0,37	1,13	1440	60,6	55	-20/+50	41
HERON AH 450P3U-4T0,37	450.4.3	400-50	0,37	1,13	1440	60,7	55	-20/+50	41
HERON AH 450P4U-4T0,55	450.4.4	400-50	0,55	1,55	1440	59,4	55	-20/+50	42
HERON AH 450P5U-4T0,37	450.4.5	400-50	0,37	1,13	1440	59,4	55	-20/+50	42
HERON AH 450P6U-4T0,55	450.4.6	400-50	0,55	1,55	1440	59,4	55	-20/+50	42
HERON AH 450P7U-4T0,75	450.4.7	400-50	0,75	2	1440	59,5	55	-20/+50	46
HERON AH 500P1U-4T0,37	500.4.1	400-50	0,37	1,13	1440	57,7	55	-20/+50	37
HERON AH 500P2U-4T0,55	500.4.2	400-50	0,55	1,55	1440	62,5	55	-20/+50	37
HERON AH 500P3U-4T0,37	500.4.3	400-50	0,37	1,13	1440	63,6	55	-20/+50	37
HERON AH 500P4U-4T0,75	500.4.4	400-50	0,75	2	1440	62,8	55	-20/+50	41
HERON AH 500P5U-4T0,55	500.4.5	400-50	0,55	1,55	1440	63,8	55	-20/+50	38
HERON AH 500P6U-4T0,75	500.4.6	400-50	0,75	2	1440	63,8	55	-20/+50	42
HERON AH 500P7U-4T1,1	500.4.7	400-50	1,1	2,6	1440	64,5	55	-20/+50	48
HERON AH 560P1U-4T0,37	560.4.1	400-50	0,37	1,13	1440	64,6	55	-20/+50	60
HERON AH 560P2U-4T0,55	560.4.2	400-50	0,55	1,55	1440	64,2	55	-20/+50	60
HERON AH 560P3U-4T0,75	560.4.3	400-50	0,75	2	1440	65,5	55	-20/+50	64
HERON AH 560P4U-4T0,75	560.4.4	400-50	0,75	2	1440	66	55	-20/+50	64
HERON AH 560P5U-4T1,1	560.4.5	400-50	1,1	2,6	1440	65,7	55	-20/+50	70
HERON AH 560P6U-4T0,37	560.4.6	400-50	0,37	1,13	1440	66,3	55	-20/+50	61
HERON AH 560P7U-4T0,75	560.4.7	400-50	0,75	2	1440	65,8	55	-20/+50	65
HERON AH 560P8U-4T1,1	560.4.8	400-50	1,1	2,6	1440	64,8	55	-20/+50	71
HERON AH 560P9U-4T1,1	560.4.9	400-50	1,1	2,6	1440	65,3	55	-20/+50	70
HERON AH 560P10U-4T1,5	560.4.10	400-50	1,5	3,5	1440	66,2	55	-20/+50	74
HERON AH 630P1U-4T0,55	630.4.1	400-50	0,55	1,55	1440	66,4	55	-20/+50	76
HERON AH 630P2U-4T0,55	630.4.2	400-50	0,55	1,55	1440	66	55	-20/+50	76
HERON AH 630P3U-4T0,75	630.4.3	400-50	0,75	2	1440	64,2	55	-20/+50	80
HERON AH 630P4U-4T1,1	630.4.4	400-50	1,1	2,6	1440	67,6	55	-20/+50	82
HERON AH 630P5U-4T1,5	630.4.5	400-50	1,5	3,5	1440	68,4	55	-20/+50	85
HERON AH 630P6U-4T0,75	630.4.6	400-50	0,75	2	1440	67,2	55	-20/+50	80
HERON AH 630P7U-4T2,2	630.4.7	400-50	2,2	5	1440	71,1	55	-20/+50	87
HERON AH 630P8U-4T0,75	630.4.8	400-50	0,75	2	1440	67,8	55	-20/+50	80
HERON AH 630P9U-4T0,75	630.4.9	400-50	0,75	2	1440	73	55	-20/+50	80
HERON AH 630P10U-4T1,1	630.4.10	400-50	1,1	2,6	1440	66,5	55	-20/+50	82
HERON AH 630P11U-4T1,5	630.4.11	400-50	1,5	3,5	1440	66,4	55	-20/+50	86
HERON AH 630P12U-4T1,5	630.4.12	400-50	1,5	3,5	1440	67	55	-20/+50	85
HERON AH 630P13U-4T2,2	630.4.13	400-50	2,2	5	1440	68	55	-20/+50	87
HERON AH 630P14U-4T2,2	630.4.14	400-50	2,2	5	1440	68,1	55	-20/+50	88
HERON AH 630P15U-4T1,5	630.4.15	400-50	1,5	3,5	1440	71,3	55	-20/+50	86

MODEL	MODEL NUMBER	Voltage Frequency	Motor Power	Current	Rotation Speed	Sound Pressure	Protection Class	Working Range	Mass
		V-Hz	kW	A	RPM	Lp(A) dB at 3m	IP	°C	~ Kg
HERON AH 630P16U-4T2,2	630.4.16	400-50	2,2	5	1440	71,2	55	-20/+50	88
HERON AH 630P17U-4T2,2	630.4.17	400-50	2,2	5	1440	71,1	55	-20/+50	88
HERON AH 630P18U-4T2,2	630.4.18	400-50	2,2	5	1440	71,4	55	-20/+50	88
HERON AH 630P19U-4T3	630.4.19	400-50	3	6,6	1440	72,8	55	-20/+50	95
HERON AH 710P1U-4T0,75	710.4.1	400-50	0,75	2	1440	71,8	55	-20/+50	84
HERON AH 710P2U-4T1,5	710.4.2	400-50	1,5	3,5	1440	69	55	-20/+50	89
HERON AH 710P3U-4T1,5	710.4.3	400-50	1,5	3,5	1440	71,9	55	-20/+50	89
HERON AH 710P4U-4T2,2	710.4.4	400-50	2,2	5	1440	72	55	-20/+50	91
HERON AH 710P5U-4T3	710.4.5	400-50	3	6,6	1440	72,8	55	-20/+50	97
HERON AH 710P6U-4T3	710.4.6	400-50	3	6,6	1440	73,5	55	-20/+50	97
HERON AH 710P7U-4T3	710.4.7	400-50	3	6,6	1440	74,1	55	-20/+50	98
HERON AH 710P8U-4T1,5	710.4.8	400-50	1,5	3,5	1440	69,8	55	-20/+50	91
HERON AH 710P9U-4T2,2	710.4.9	400-50	2,2	5	1440	68,2	55	-20/+50	93
HERON AH 710P10U-4T2,2	710.4.10	400-50	2,2	5	1440	73,8	55	-20/+50	92
HERON AH 710P11U-4T3	710.4.11	400-50	3	6,6	1440	73	55	-20/+50	98
HERON AH 710P12U-4T4	710.4.12	400-50	4	8,4	1440	73,5	55	-20/+50	110
HERON AH 710P13U-4T4	710.4.13	400-50	4	8,4	1440	72,5	55	-20/+50	108
HERON AH 710P14U-4T5,5	710.4.14	400-50	5,5	11,2	1440	73,5	55	-20/+50	119
HERON AH 800P1U-4T2,2	800.4.1	400-50	2,2	5	1440	76,8	55	-20/+50	101
HERON AH 800P2U-4T3	800.4.2	400-50	3	6,6	1440	75	55	-20/+50	107
HERON AH 800P3U-4T3	800.4.3	400-50	3	6,6	1440	74,1	55	-20/+50	107
HERON AH 800P4U-4T4	800.4.4	400-50	4	8,4	1440	75,1	55	-20/+50	124
HERON AH 800P5U-4T4	800.4.5	400-50	4	8,4	1440	75,3	55	-20/+50	124
HERON AH 800P6U-4T4	800.4.6	400-50	4	8,4	1440	74,6	55	-20/+50	124
HERON AH 800P7U-4T5,5	800.4.7	400-50	5,5	11,2	1440	76,1	55	-20/+50	135
HERON AH 800P8U-4T5,5	800.4.8	400-50	5,5	11,2	1440	76,8	55	-20/+50	135
HERON AH 800P9U-4T1,5	800.4.9	400-50	1,5	3,5	1440	79,2	55	-20/+50	99
HERON AH 800P10U-4T3	800.4.10	400-50	3	6,6	1440	78,1	55	-20/+50	108
HERON AH 800P11U-4T4	800.4.11	400-50	4	8,4	1440	76,7	55	-20/+50	125
HERON AH 800P12U-4T5,5	800.4.12	400-50	5,5	11,2	1440	75,7	55	-20/+50	136
HERON AH 800P13U-4T7,5	800.4.13	400-50	7,5	15,4	1440	76,7	55	-20/+50	142
HERON AH 800P14U-4T2,2	800.4.14	400-50	2,2	5	1440	78,3	55	-20/+50	102
HERON AH 800P15U-4T11	800.4.15	400-50	11	21,3	1440	77,1	55	-20/+50	199
HERON AH 800P16U-4T7,5	800.4.16	400-50	7,5	15,4	1440	76,9	55	-20/+50	144
HERON AH 800P17U-4T11	800.4.17	400-50	11	21,3	1440	77,4	55	-20/+50	199
HERON AH 800P18U-4T4	800.4.18	400-50	4	8,4	1440	77,8	55	-20/+50	131
HERON AH 800P19U-4T4	800.4.19	400-50	4	8,4	1440	78	55	-20/+50	131
HERON AH 800P20U-4T5,5	800.4.20	400-50	5,5	11,2	1440	77,5	55	-20/+50	142
HERON AH 800P21U-4T5,5	800.4.21	400-50	5,5	11,2	1440	76,9	55	-20/+50	142
HERON AH 900P1U-4T5,5	900.4.1	400-50	5,5	11,2	1440	82,7	55	-20/+50	145
HERON AH 900P2U-4T7,5	900.4.2	400-50	7,5	15,4	1440	76,5	55	-20/+50	152
HERON AH 900P3U-4T4	900.4.3	400-50	4	8,4	1440	76,3	55	-20/+50	135
HERON AH 900P4U-4T5,5	900.4.4	400-50	5,5	11,2	1440	76,4	55	-20/+50	146
HERON AH 900P5U-4T4	900.4.5	400-50	4	8,4	1440	79,9	55	-20/+50	135
HERON AH 900P6U-4T5,5	900.4.6	400-50	5,5	11,2	1440	79,1	55	-20/+50	146
HERON AH 900P7U-4T7,5	900.4.7	400-50	7,5	15,4	1440	79,2	55	-20/+50	153

MODEL	MODEL NUMBER	Voltage Frequency	Motor Power	Current	Rotation Speed	Sound Pressure	Protection Class	Working Range	Mass
		V-Hz	kW	A	RPM	Lp(A) dB at 3m	IP	°C	~ Kg
HERON AH 900P8U-4T7,5	900.4.8	400-50	7,5	15,4	1440	77,7	55	-20/+50	153
HERON AH 900P9U-4T7,5	900.4.9	400-50	7,5	15,4	1440	78,5	55	-20/+50	153
HERON AH 900P10U-4T7,5	900.4.10	400-50	7,5	15,4	1440	79,2	55	-20/+50	153
HERON AH 900P11U-4T11	900.4.11	400-50	11	21,3	1440	78,8	55	-20/+50	200
HERON AH 900P12U-4T11	900.4.12	400-50	11	21,3	1440	78,9	55	-20/+50	200
HERON AH 900P13U-4T15	900.4.13	400-50	15	29,8	1440	78	55	-20/+50	220
HERON AH 900P14U-4T7,5	900.4.14	400-50	7,5	15,4	1440	79,1	55	-20/+50	154
HERON AH 900P15U-4T7,5	900.4.15	400-50	7,5	15,4	1440	81,9	55	-20/+50	154
HERON AH 900P16U-4T11	900.4.16	400-50	11	21,3	1440	83,8	55	-20/+50	201
HERON AH 900P17U-4T15	900.4.17	400-50	15	29,8	1440	79,7	55	-20/+50	222
HERON AH 900P18U-4T15	900.4.18	400-50	15	29,8	1440	79,5	55	-20/+50	222
HERON AH 900P19U-4T15	900.4.19	400-50	15	29,8	1440	80,3	55	-20/+50	222
HERON AH 900P20U-4T11	900.4.20	400-50	11	21,3	1440	79,4	55	-20/+50	206
HERON AH 900P21U-4T11	900.4.21	400-50	11	21,3	1440	79,4	55	-20/+50	206
HERON AH 900P22U-4T15	900.4.22	400-50	15	29,8	1440	77,6	55	-20/+50	226
HERON AH 1000P1U-4T3	1000.4.1	400-50	3	6,6	1440	76,1	55	-20/+50	158
HERON AH 1000P2U-4T3	1000.4.2	400-50	3	6,6	1440	77	55	-20/+50	183
HERON AH 1000P3U-4T4	1000.4.3	400-50	4	8,4	1440	77,7	55	-20/+50	189
HERON AH 1000P4U-4T4	1000.4.4	400-50	4	8,4	1440	78,5	55	-20/+50	189
HERON AH 1000P5U-4T5,5	1000.4.5	400-50	5,5	11,2	1440	78,4	55	-20/+50	206
HERON AH 1000P6U-4T7,5	1000.4.6	400-50	7,5	15,4	1440	81,7	55	-20/+50	213
HERON AH 1000P7U-4T11	1000.4.7	400-50	11	21,3	1440	83,4	55	-20/+50	276
HERON AH 1000P8U-4T5,5	1000.4.8	400-50	5,5	11,2	1440	77,8	55	-20/+50	207
HERON AH 1000P9U-4T7,5	1000.4.9	400-50	7,5	15,4	1440	79,3	55	-20/+50	214
HERON AH 1000P10U-4T5,5	1000.4.10	400-50	5,5	11,2	1440	80,9	55	-20/+50	208
HERON AH 1000P11U-4T7,5	1000.4.11	400-50	7,5	15,4	1440	84	55	-20/+50	215
HERON AH 1000P12U-4T11	1000.4.12	400-50	11	21,3	1440	82	55	-20/+50	252
HERON AH 1000P13U-4T11	1000.4.13	400-50	11	21,3	1440	82,4	55	-20/+50	252
HERON AH 1000P14U-4T15	1000.4.14	400-50	15	29,8	1440	83,8	55	-20/+50	272
HERON AH 1000P15U-4T15	1000.4.15	400-50	15	29,8	1440	84,4	55	-20/+50	272
HERON AH 1000P16U-4T7,5	1000.4.16	400-50	7,5	15,4	1440	81,7	55	-20/+50	208
HERON AH 1000P17U-4T7,5	1000.4.17	400-50	7,5	15,4	1440	81,3	55	-20/+50	208
HERON AH 1000P18U-4T11	1000.4.18	400-50	11	21,3	1440	81,3	55	-20/+50	269
HERON AH 1000P19U-4T11	1000.4.19	400-50	11	21,3	1440	82	55	-20/+50	269
HERON AH 1000P20U-4T11	1000.4.20	400-50	11	21,3	1440	86,5	55	-20/+50	276
HERON AH 1000P21U-4T11	1000.4.21	400-50	11	21,3	1440	86,5	55	-20/+50	276
HERON AH 1000P22U-4T15	1000.4.22	400-50	15	29,8	1440	85,5	55	-20/+50	296
HERON AH 1000P23U-4T15	1000.4.23	400-50	15	29,8	1440	84,4	55	-20/+50	296
HERON AH 1000P24U-4T22	1000.4.24	400-50	22	42,5	1440	85,5	55	-20/+50	351
HERON AH 1000P25.AU-4T11	1000.4.25.A	400-50	11	21,3	1440	79,3	55	-20/+50	280
HERON AH 1000P25.BU-4T15	1000.4.25.B	400-50	15	29,8	1440	79,3	55	-20/+50	300
HERON AH 1000P26U-4T15	1000.4.26	400-50	15	29,8	1440	81	55	-20/+50	300
HERON AH 1000P27U-4T22	1000.4.27	400-50	22	42,5	1440	82,4	55	-20/+50	355
HERON AH 1000P28U-4T30	1000.4.28	400-50	30	55	1440	85,1	55	-20/+50	362
HERON AH 1000P29U-4T22	1000.4.29	400-50	22	42,5	1440	83,5	55	-20/+50	355
HERON AH 1000P30U-4T30	1000.4.30	400-50	30	55	1440	83,8	55	-20/+50	370

MODEL	MODEL NUMBER	Voltage Frequency	Motor Power	Current	Rotation Speed	Sound Pressure	Protection Class	Working Range	Mass
		V-Hz	kW	A	RPM	Lp(A) dB at 3m	IP	°C	~ Kg
HERON AH 1000P31U-4T7,5	1000.4.31	400-50	7,5	15,4	1440	84,8	55	-20/+50	209
HERON AH 1000P32U-4T11	1000.4.32	400-50	11	21,3	1440	81,9	55	-20/+50	270
HERON AH 1000P33U-4T15	1000.4.33	400-50	15	29,8	1440	81,4	55	-20/+50	290
HERON AH 1000P34U-4T22	1000.4.34	400-50	22	42,5	1440	88,5	55	-20/+50	351
HERON AH 1000P35U-4T22	1000.4.35	400-50	22	42,5	1440	88,5	55	-20/+50	351
HERON AH 1000P36U-4T30	1000.4.36	400-50	30	55	1440	87,5	55	-20/+50	366
HERON AH 1000P37U-4T37	1000.4.37	400-50	37	67	1440	86,5	55	-20/+50	466
HERON AH 1120P1U-4T5,5	1120.4.1	400-50	5,5	11,2	1440	81,5	55	-20/+50	304
HERON AH 1120P2U-4T7,5	1120.4.2	400-50	7,5	15,4	1440	82,1	55	-20/+50	311
HERON AH 1120P3U-4T11	1120.4.3	400-50	11	21,3	1440	83,6	55	-20/+50	329
HERON AH 1120P4U-4T11	1120.4.4	400-50	11	21,3	1440	83,8	55	-20/+50	327
HERON AH 1120P5U-4T15	1120.4.5	400-50	15	29,8	1440	85,1	55	-20/+50	349
HERON AH 1120P6U-4T18,5	1120.4.6	400-50	18,5	34,5	1440	86,5	55	-20/+50	410
HERON AH 1120P7U-4T7,5	1120.4.7	400-50	7,5	15,4	1440	83,1	55	-20/+50	313
HERON AH 1120P8U-4T11	1120.4.8	400-50	11	21,3	1440	86,5	55	-20/+50	329
HERON AH 1120P9U-4T11	1120.4.9	400-50	11	21,3	1440	85,5	55	-20/+50	329
HERON AH 1120P10U-4T15	1120.4.10	400-50	15	29,8	1440	84,3	55	-20/+50	349
HERON AH 1120P11U-4T15	1120.4.11	400-50	15	29,8	1440	83,8	55	-20/+50	349
HERON AH 1120P12U-4T18,5	1120.4.12	400-50	18,5	34,5	1440	85,5	55	-20/+50	410
HERON AH 1120P13U-4T22	1120.4.13	400-50	22	42,5	1440	86,5	55	-20/+50	425
HERON AH 1120P14U-4T22	1120.4.14	400-50	22	42,5	1440	87,5	55	-20/+50	425
HERON AH 1120P15U-4T22	1120.4.15	400-50	22	42,5	1440	86,5	55	-20/+50	425
HERON AH 1120P16U-4T11	1120.4.16	400-50	11	21,3	1440	88,5	55	-20/+50	329
HERON AH 1120P17U-4T15	1120.4.17	400-50	15	29,8	1440	88,5	55	-20/+50	349
HERON AH 1120P18U-4T15	1120.4.18	400-50	15	29,8	1440	88,5	55	-20/+50	349
HERON AH 1120P19U-4T22	1120.4.19	400-50	22	42,5	1440	86,5	55	-20/+50	425
HERON AH 1120P20U-4T30	1120.4.20	400-50	30	55	1440	89,5	55	-20/+50	440
HERON AH 1120P21U-4T5,5	1120.4.21	400-50	5,5	11,2	1440	89,5	55	-20/+50	301
HERON AH 1120P22U-4T7,5	1120.4.22	400-50	7,5	15,4	1440	89,5	55	-20/+50	308
HERON AH 1120P23U-4T11	1120.4.23	400-50	11	21,3	1440	85,1	55	-20/+50	323
HERON AH 1120P24U-4T15	1120.4.24	400-50	15	29,8	1440	84,6	55	-20/+50	343
HERON AH 1120P25U-4T18,5	1120.4.25	400-50	18,5	34,5	1440	83,6	55	-20/+50	405
HERON AH 1120P26U-4T11	1120.4.26	400-50	11	21,3	1440	89,5	55	-20/+50	333
HERON AH 1120P27U-4T15	1120.4.27	400-50	15	29,8	1440	89,5	55	-20/+50	353
HERON AH 1120P28U-4T15	1120.4.28	400-50	15	29,8	1440	88,5	55	-20/+50	353
HERON AH 1120P29U-4T18,5	1120.4.29	400-50	18,5	34,5	1440	87,5	55	-20/+50	414
HERON AH 1120P30U-4T18,5	1120.4.30	400-50	18,5	34,5	1440	87,5	55	-20/+50	414
HERON AH 1120P31U-4T22	1120.4.31	400-50	22	42,5	1440	87,5	55	-20/+50	429
HERON AH 1120P32U-4T30	1120.4.32	400-50	30	55	1440	86,5	55	-20/+50	444
HERON AH 1120P33U-4T37	1120.4.33	400-50	37	67	1440	86,5	55	-20/+50	544
HERON AH 1120P34U-4T22	1120.4.34	400-50	22	42,5	1440	88,5	55	-20/+50	425
HERON AH 1120P35U-4T30	1120.4.35	400-50	30	55	1440	87,5	55	-20/+50	440
HERON AH 1120P36U-4T15	1120.4.36	400-50	15	29,8	1440	90,5	55	-20/+50	358
HERON AH 1120P37U-4T22	1120.4.37	400-50	22	42,5	1440	87,5	55	-20/+50	434
HERON AH 1120P38U-4T45	1120.4.38	400-50	45	80	1440	87,5	55	-20/+50	649
HERON AH 1120P39U-4T22	1120.4.39	400-50	22	42,5	1440	83,1	55	-20/+50	421

MODEL	MODEL NUMBER	Voltage Frequency	Motor Power	Current	Rotation Speed	Sound Pressure	Protection Class	Working Range	Mass
		V-Hz	kW	A	RPM	Lp(A) dB at 3m	IP	°C	~ Kg
HERON AH 1120P40U-4T30	1120.4.40	400-50	30	55	1440	84,1	55	-20/+50	436
HERON AH 1250P1U-4T11	1250.4.1	400-50	11	21,3	1440	89,5	55	-20/+50	355
HERON AH 1250P2U-4T15	1250.4.2	400-50	15	29,8	1440	88,5	55	-20/+50	375
HERON AH 1250P3U-4T18,5	1250.4.3	400-50	18,5	34,5	1440	88,5	55	-20/+50	415
HERON AH 1250P4U-4T18,5	1250.4.4	400-50	18,5	34,5	1440	88,5	55	-20/+50	415
HERON AH 1250P5U-4T22	1250.4.5	400-50	22	42,5	1440	88,5	55	-20/+50	430
HERON AH 1250P6U-4T11	1250.4.6	400-50	11	21,3	1440	93,5	55	-20/+50	355
HERON AH 1250P7U-4T18,5	1250.4.7	400-50	18,5	34,5	1440	94,5	55	-20/+50	415
HERON AH 1250P8U-4T22	1250.4.8	400-50	22	42,5	1440	94,5	55	-20/+50	430
HERON AH 1250P9U-4T22	1250.4.9	400-50	22	42,5	1440	94,5	55	-20/+50	430
HERON AH 1250P10U-4T22	1250.4.10	400-50	22	42,5	1440	94,5	55	-20/+50	430
HERON AH 1250P11U-4T30	1250.4.11	400-50	30	55	1440	92,5	55	-20/+50	483
HERON AH 1250P12U-4T30	1250.4.12	400-50	30	55	1440	93,5	55	-20/+50	483
HERON AH 1250P13U-4T30	1250.4.13	400-50	30	55	1440	87,5	55	-20/+50	483
HERON AH 1250P14U-4T30	1250.4.14	400-50	30	55	1440	93,5	55	-20/+50	483
HERON AH 1250P15U-4T30	1250.4.15	400-50	30	55	1440	88,5	55	-20/+50	483
HERON AH 1250P16U-4T30	1250.4.16	400-50	30	55	1440	89,5	55	-20/+50	483
HERON AH 1250P17U-4T37	1250.4.17	400-50	37	67	1440	89,5	55	-20/+50	583
HERON AH 1250P18U-4T37	1250.4.18	400-50	37	67	1440	89,5	55	-20/+50	583
HERON AH 1250P19U-4T37	1250.4.19	400-50	37	67	1440	89,5	55	-20/+50	583
HERON AH 1250P20U-4T45	1250.4.20	400-50	45	80	1440	89,5	55	-20/+50	683
HERON AH 1250P21U-4T45	1250.4.21	400-50	45	80	1440	89,5	55	-20/+50	683
HERON AH 1250P22U-4T45	1250.4.22	400-50	45	80	1440	89,5	55	-20/+50	683
HERON AH 1250P23U-4T45	1250.4.23	400-50	45	80	1440	47,5	55	-20/+50	683
HERON AH 1250P24U-4T45	1250.4.24	400-50	45	80	1440	90,5	55	-20/+50	683
HERON AH 1250P25U-4T55	1250.4.25	400-50	55	96,8	1440	91,5	55	-20/+50	713
HERON AH 1250P26U-4T55	1250.4.26	400-50	55	96,8	1440	91,5	55	-20/+50	713
HERON AH 1250P27U-4T55	1250.4.27	400-50	55	96,8	1440	91,5	55	-20/+50	713
HERON AH 1250P28U-4T22	1250.4.28	400-50	22	42,5	1440	94,5	55	-20/+50	430
HERON AH 1250P29.AU-4T22	1250.4.29.A	400-50	22	42,5	1440	94,5	55	-20/+50	430
HERON AH 1250P29.BU-4T30	1250.4.29.B	400-50	30	55	1440	94,5	55	-20/+50	483
HERON AH 1250P30.AU-4T30	1250.4.30.A	400-50	30	55	1440	92,5	55	-20/+50	483
HERON AH 1250P30.BU-4T37	1250.4.30.B	400-50	37	67	1440	92,5	55	-20/+50	583
HERON AH 1250P31.AU-4T30	1250.4.31.A	400-50	30	55	1440	92,5	55	-20/+50	483
HERON AH 1250P31.BU-4T37	1250.4.31.B	400-50	37	67	1440	92,5	55	-20/+50	583
HERON AH 1250P32U-4T45	1250.4.32	400-50	45	80	1440	90,5	55	-20/+50	683
HERON AH 1250P33U-4T55	1250.4.33	400-50	55	96,8	1440	89,5	55	-20/+50	713
HERON AH 1250P34U-4T55	1250.4.34	400-50	55	96,8	1440	89,5	55	-20/+50	713
HERON AH 1250P35U-4T55	1250.4.35	400-50	55	96,8	1440	89,5	55	-20/+50	713
HERON AH 1250P36U-4T11	1250.4.36	400-50	11	21,3	1440	82,5	55	-20/+50	360
HERON AH 1250P37U-4T18,5	1250.4.37	400-50	18,5	34,5	1440	84,8	55	-20/+50	420
HERON AH 1250P38U-4T22	1250.4.38	400-50	22	42,5	1440	85,4	55	-20/+50	435
HERON AH 1250P39U-4T30	1250.4.39	400-50	30	55	1440	90,5	55	-20/+50	488
HERON AH 1250P40U-4T30	1250.4.40	400-50	30	55	1440	91,5	55	-20/+50	488
HERON AH 1250P41U-4T37	1250.4.41	400-50	37	67	1440	88,5	55	-20/+50	588
HERON AH 1250P42U-4T37	1250.4.42	400-50	37	67	1440	89,5	55	-20/+50	588

NOVVES

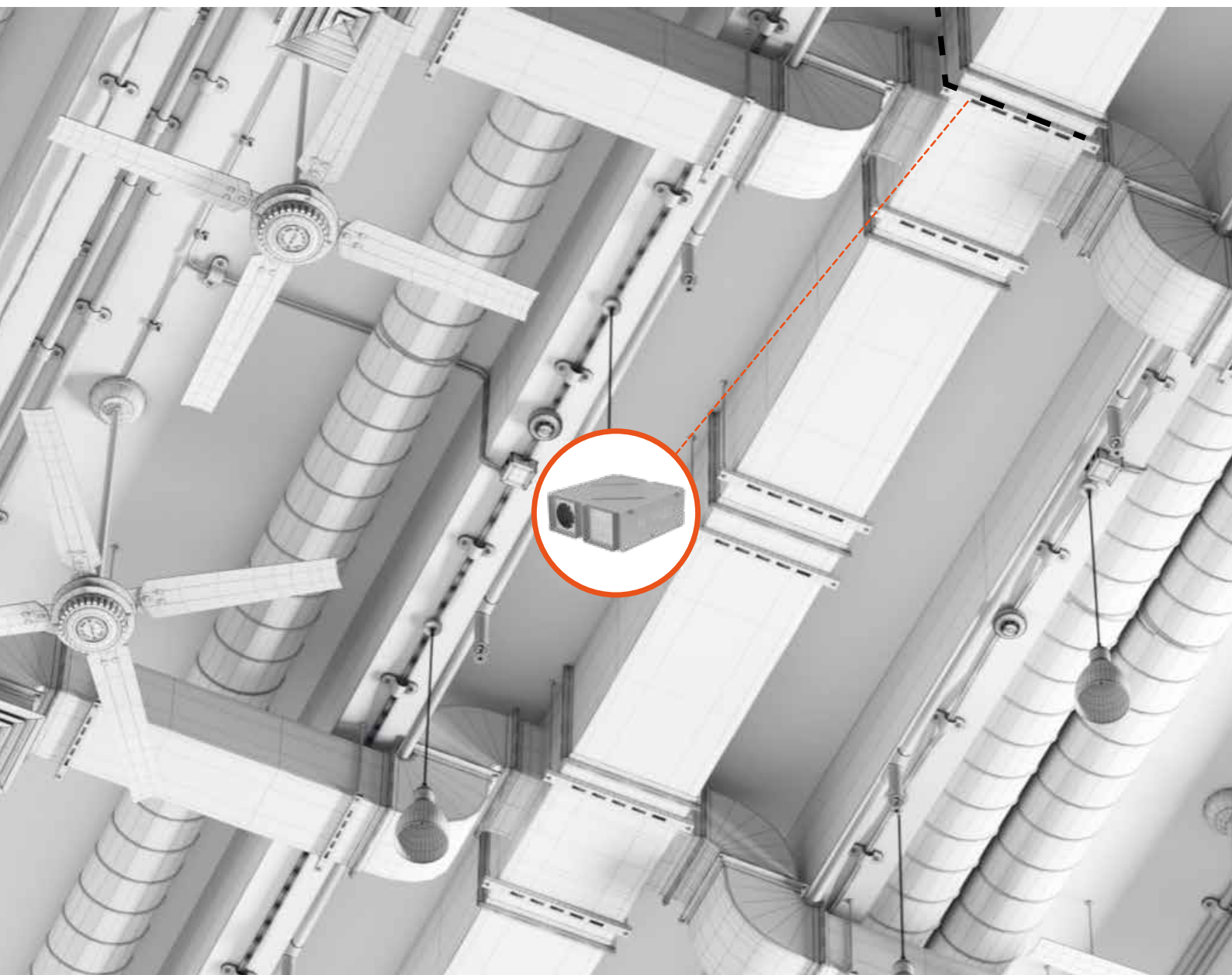

Caracal
Heat Recovery Fan

CARACAL SERIES



General

Caracal series fans provide controlled air conditioning in order to meet the need for fresh air and increase the existing air quality in social areas such as offices, schools, hotels, hospitals, business centers, shopping centers, show centers, cafeterias. CARACAL D series has been produced to provide climate control by performing heat transfer without mixing the exhausted air and the fresh air taken from outside through the aluminum plate heat recovery exchanger.

A part of the energy to be spent for heating or cooling the fresh air is gained from the air to be exhausted in the environment, thus reducing the initial investment and operating costs of the air conditioning systems and saving energy.

Body

The body is made of galvanized sheet. Coating options with epoxy paint or electrostatic powder paint are also available. Body consists of high efficiency plate heat exchanger, external rotor motor fan, filters and control panel components. Optionally, it is also possible to produce with an electric heater. Polyethylene insulation material is used for sound insulation and heat insulation of the device. There is also a condensation pan designed to remove condensation in the Plate heat exchanger. Fresh air and exhaust fans and filters together with the heat recovery exchanger are compactly collected in a case. Polyethylene insulation material is used in the sound and heat insulation of the product.

Impeller

A backward curved, sparse and aerodynamically designed plug fan is used in the device. While this design provides regular flow, at the same time, since the fans are directly connected to the motor, belt-pulley problems are eliminated and maintenance costs are reduced. Impellers dynamically and statically balanced in accordance with ISO 1940

Motor

All models are equipped with an external rotor motor with a closed structure and suitable for operation up to a maximum of 40°C.

IP Class

All models of this Series are in IP 44 protection, F insulation class.

Control

Control of electric heater or heater/cooler coils, if any, can be done on the control panel of the heat recovery device. Ventilation at desired capacities can be operated with manual or automatic time adjustment on the touch color screen of the room panel connected to the control panel. When the desired room temperature is set, the heating equipment works automatically and adjusts the capacity. Fault warnings also appear on the room panel display. If a sensor (optional) is added, filter contamination status information can also be obtained.

Fan Code

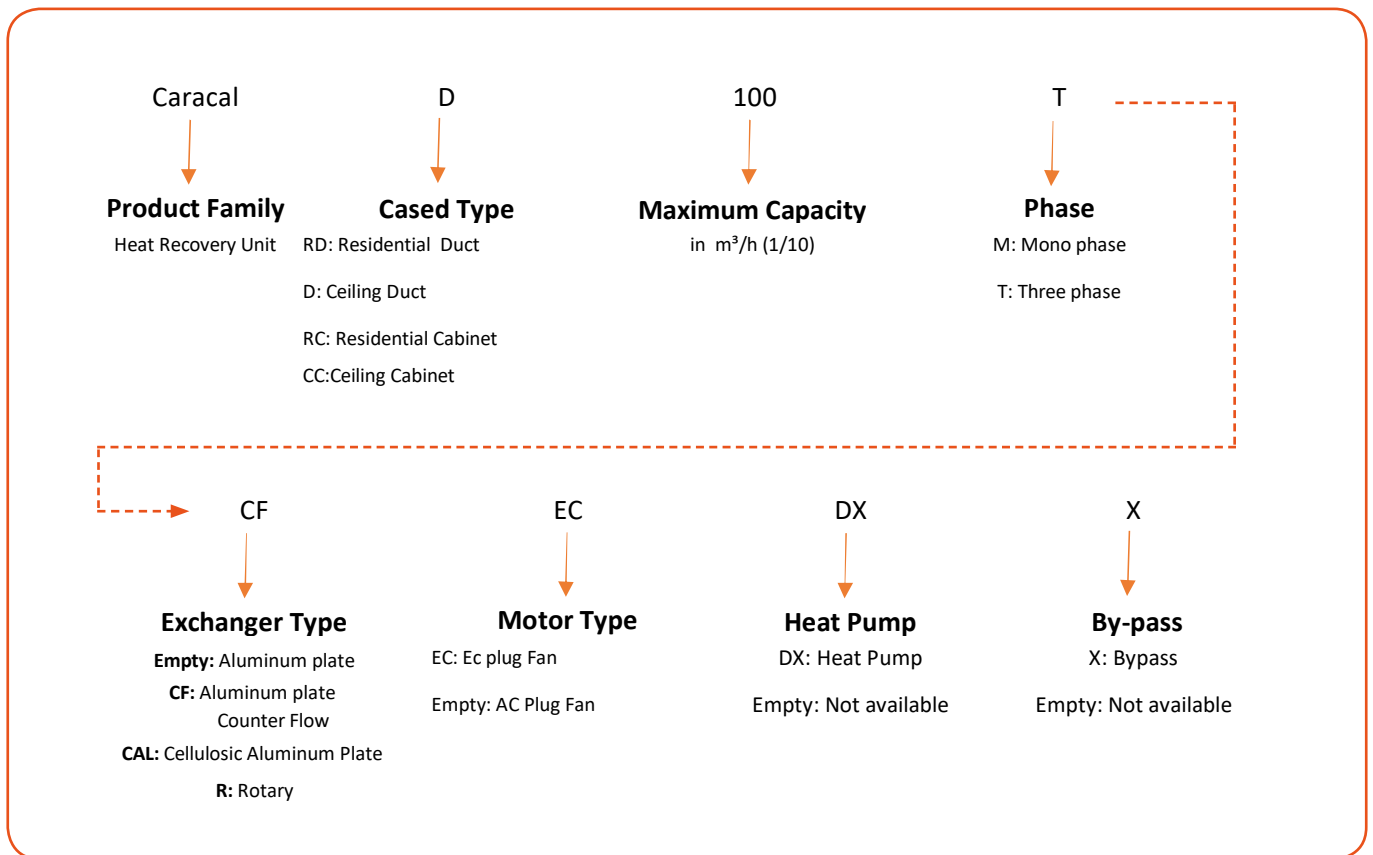

HEAT RECOVERY UNITS



- Body manufactured from high quality galvanized sheet
- Suitable for max. 40°C operation
- Washable G2 Filter
- Touch Control Panel are included
- Rotational speed can be set with speed controller
- Eurovent certificated recuperator has been used for heat efficiency.

CARACAL D - SYSTEM CURVE

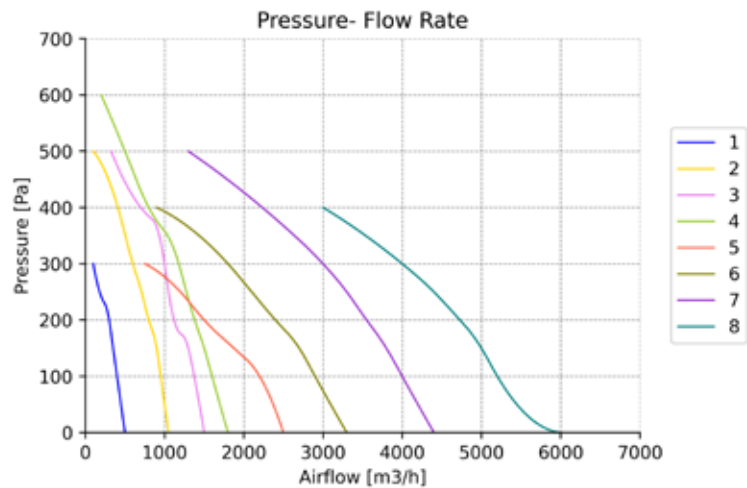

CONTROL TOUCH PANEL



- User friendly interface
- Suitable for every Caracal D series
- Multiple language options
- Digital input and output assign
- Timer
- Alarm report
- Colourful touch panel
- BMS can take info from modbus protocol

CONTROL TOUCH PANEL		VOLTAGE
Model		V
AETP01		230

TECHNICAL PARAMETERS

MODEL	MODEL NUMBER	Voltage Frequency	Motor Power	Current	Rotation Speed	Sound Pressure	Protection Class	Working Range	Mass
		V-Hz	W	A	RPM	Lp(A) dB at 3m	IP	°C	Kg
CARACAL D 50	1	230-50	60x2	0,35	2700	48	44	-30/60	54
CARACAL D 100	2	230-50	135x2	0,6	2600	50	44	-30/60	71
CARACAL D 150	3	230-50	230x2	1,05	2700	52	44	-30/60	79
CARACAL D 200	4	230-50	230x2	1,1	2450	59	44	-30/60	97
CARACAL D 250	5	230-50	210x2	1	1400	43	54	-30/60	121
CARACAL D 300	6	230-50	400x2	2,6	1400	57	54	-30/60	147,5
CARACAL D 400	7	230-50	510x2	1,5	1380	46	54	-30/60	168,5
CARACAL D 600	8	230-50	800x2	3,5	1350	59	54	-30/60	175

PRODUCT DIMENSIONS

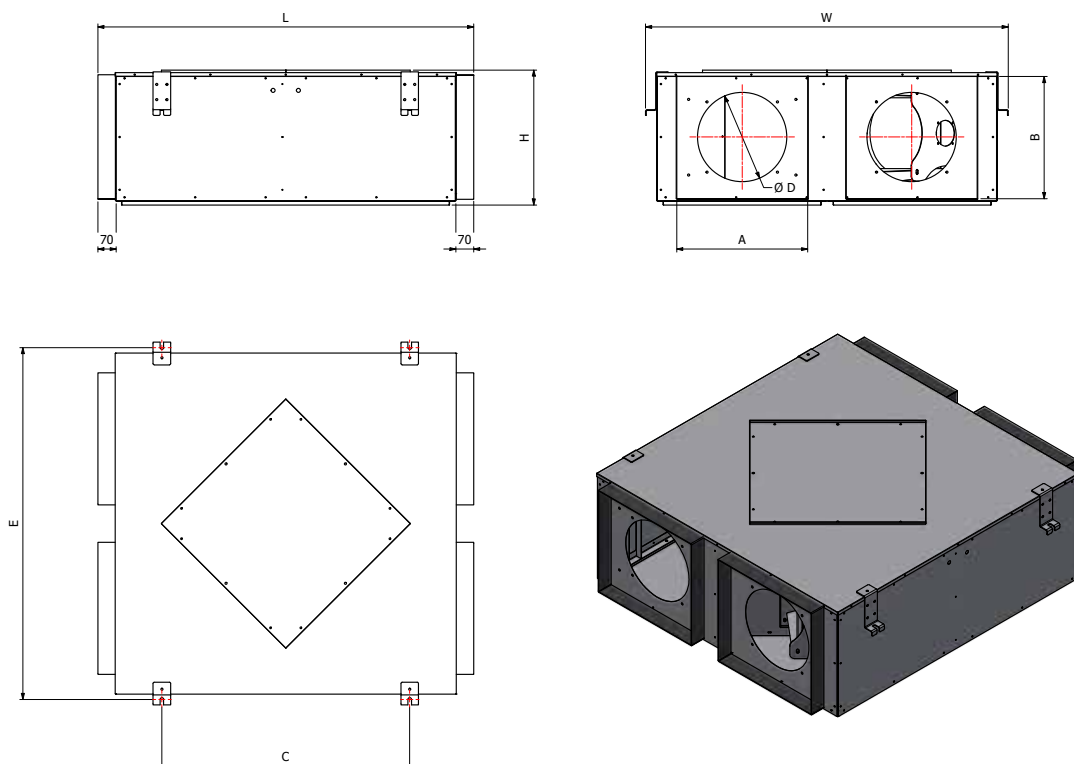

MODEL	L	W	H	A	B	C	E	ØD
CARACAL D 50	1110 mm	963 mm	505 mm	300 mm	326 mm	510 mm	920 mm	200 mm
CARACAL D 100	1172 mm	1120 mm	505 mm	418 mm	443 mm	664 mm	1077 mm	250 mm
CARACAL D 150	1172 mm	1120 mm	505 mm	418 mm	443 mm	664 mm	1070 mm	300 mm
CARACAL D 200	1172 mm	1120 mm	505 mm	418 mm	443 mm	664 mm	1070 mm	300 mm
CARACAL D 250	1312 mm	1260 mm	505 mm	475 mm	445 mm	804 mm	1215 mm	355 mm
CARACAL D 300	1492 mm	1440 mm	555 mm	525 mm	495 mm	984 mm	1397 mm	355 mm
CARACAL D 400	1492 mm	1440 mm	555 mm	525 mm	495 mm	984 mm	1397 mm	400 mm
CARACAL D 600	1692 mm	1652 mm	700 mm	640 mm	680 mm	1184mm	1597 mm	400 mm

NOVVES

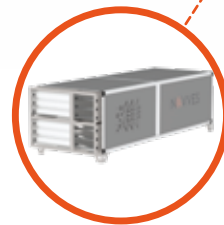
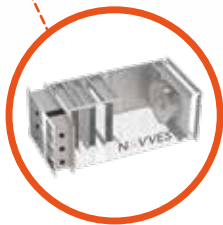

Fox
Shelter Fan



FOX SERIES

General

The Fox series is designed for use in shelters built for protection from the effects of radioactive fallout, nuclear weapons, biological and chemical warfare agents, and natural disasters. While the air taken from outside is passed through the G4 filter in normal times, in the case of protection against a chemical threat, it is passed through the active carbon filter and nuclear hepa filter and given into the shelter.

Body

Fox-C heat and sound insulated double-walled body and FOX-D single-walled body are made of galvanized sheet metal. The body is also available with an electrostatic powder coating option. Thanks to the bypass air control damper, contamination of sensitive filters is prevented except in emergencies.

Impeller

It consists of backward curved and sparsely adjusted radial blades. The propellers are dynamically and statically balanced in accordance with ISO 1940.

Motor

The fans in this series are produced with an external rotor motor with a closed structure and are suitable for operation up to a maximum of 40°C. Synchronous motor was used in the design of FOX-D Series fans, and asynchronous motor was used in the design of FOX-C Series fans.

IP Class

FOX-D is in IP 44 and FOX-C is in IP55 protection and F insulation class.

Control

Fans with single-phase motors can be operated directly with the on/off switch, while fans with three-phase motors can be operated directly with the help of the MCC panel. The speed adjustment of the models with single-phase motors is made by the speed switch, and the speed of the models with three-phase motors is made by the frequency inverter.

Fan Code

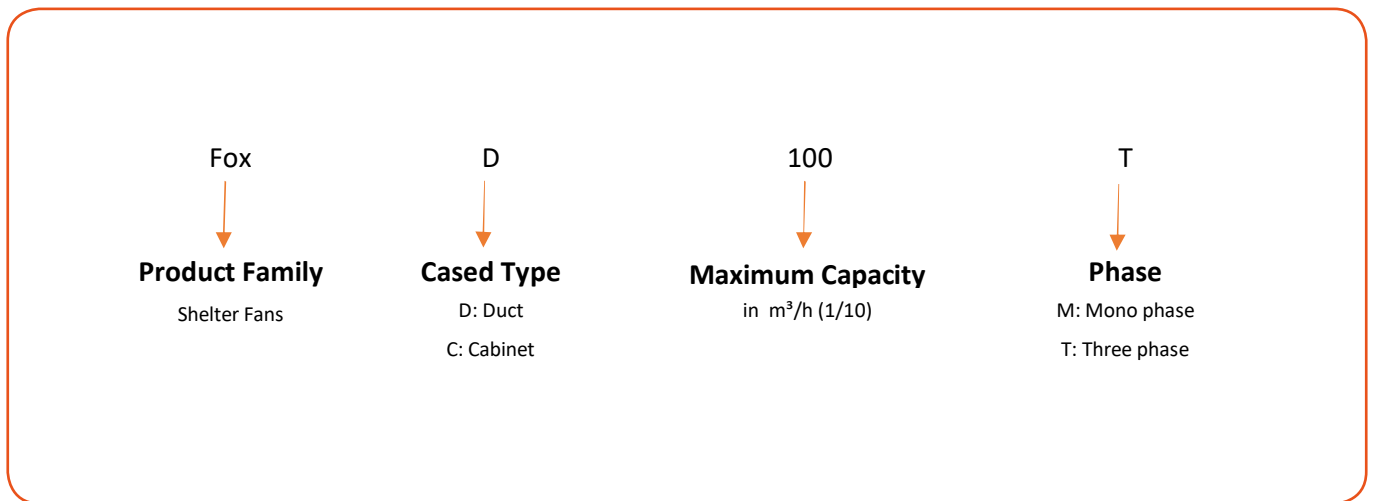



DUCT TYPES SHELTER FANS



- Body manufactured from high quality galvanized sheet
- Motor outside the air stream
- Backward curved impeller
- Suitable for max. 40°C operation
- With G4 filter, hepa filter and carbon filter
- With By-pass damper

FOX D - SYSTEM CURVE

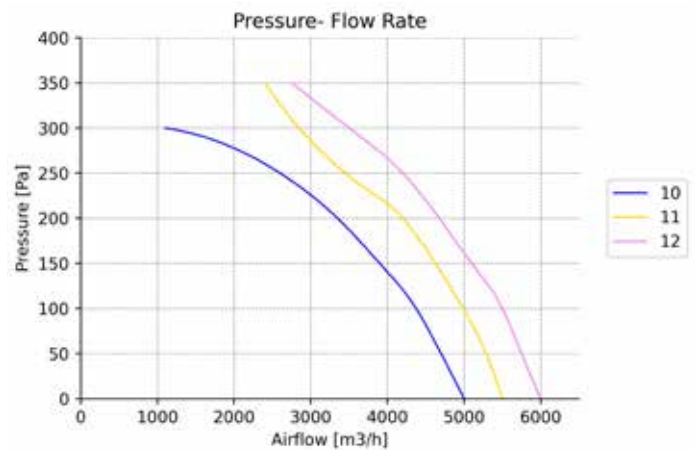
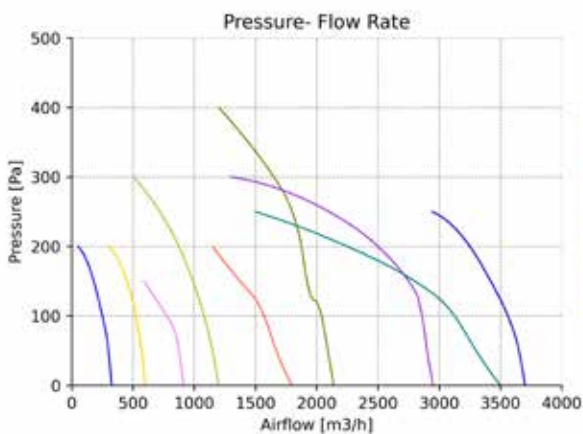

TECHNICAL PARAMETERS

MODEL	MODEL NUMBER	Voltage	Motor	Current	Rotation	Sound	Protection	Working	Mass
		Frequency	Power		Speed	Pressure	Class	Range	
		V-Hz	W	A	RPM	Lp(A) dB at 3m	IP	°C	Kg
FOX D 25M	1	230-50	80	0,38	2470	55	44	-30/60	33
FOX D 50M	2	230-50	105	0,44	2700	60	44	-30/60	34
FOX D 75M	3	230-50	105	0,44	2650	60	44	-30/60	34
FOX D 100M	4	230-50	145	0,61	2750	62	44	-30/60	58
FOX D 150M	5	230-50	350	1,2	1400	69	44	-30/60	58
FOX D 200M	6	230-50	135	0,6	1400	53	54	-30/60	77
FOX D 250M	7	230-50	170	0,78	1400	62	54	-30/60	82
FOX D 300M	8	230-50	240	1,1	1400	54	54	-30/60	83
FOX D 350M	9	230-50	510	2,35	1400	56	54	-30/60	96
FOX D 400M	10	230-50	510	2,35	1400	59	54	-30/60	97
FOX D 450M	11	230-50	510	2,35	1400	69	54	-30/60	109
FOX D 500M	12	230-50	510	2,35	1400	72	54	-30/60	116

PRODUCT DIMENSIONS

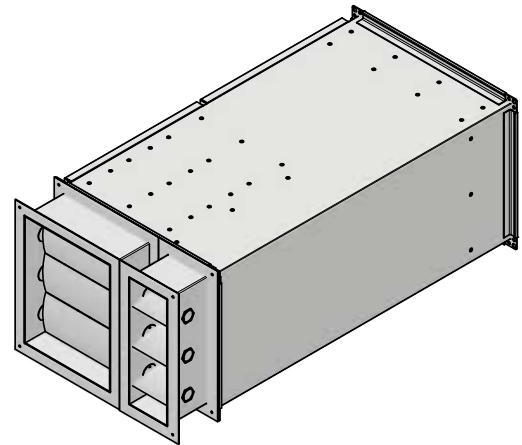
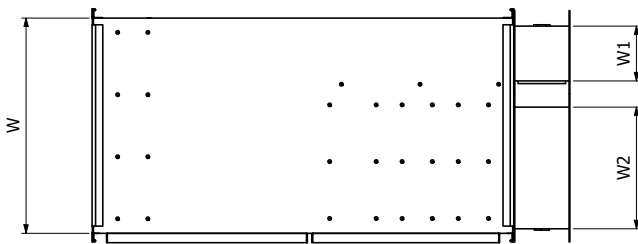
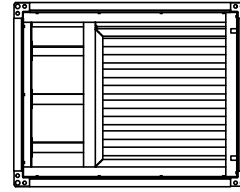
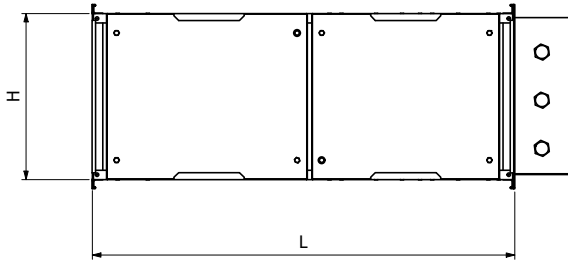

MODEL	W1	W2 (FILTER)	W	H	L	PLUG FAN
FOX D 25M	150	310	460	355	700	190-063
FOX D 50M	150	310	460	355	700	225-089
FOX D 75M	150	310	460	355	700	225-089
FOX D 100M	250	600	850	460	800	250-080
FOX D 150M	250	600	850	460	800	280-080
FOX D 200M	280	570	850	660	900	355-145
FOX D 250M	280	570	850	660	950	355-164
FOX D 300M	280	570	850	660	950	400-147
FOX D 350M	280	570	850	660	1050	400-188
FOX D 400M	280	570	850	660	1050	400-185
FOX D 450M	350	800	1150	660	1100	450-218
FOX D 500M	350	800	1150	660	1100	450-209



CABINET TYPES SHELTER FANS



- Double-walled cabinet, 20mm fiberglass insulation
- Body manufactured from high quality galvanized sheet
- Motor outside the air stream
- Backward curved impeller
- Suitable for max. 40°C operation
- G4 filter, hepa filter and carbon filter
- With By-pass damper
- Rotational speed can be set with frequency inverter

FOX C - SYSTEM CURVE

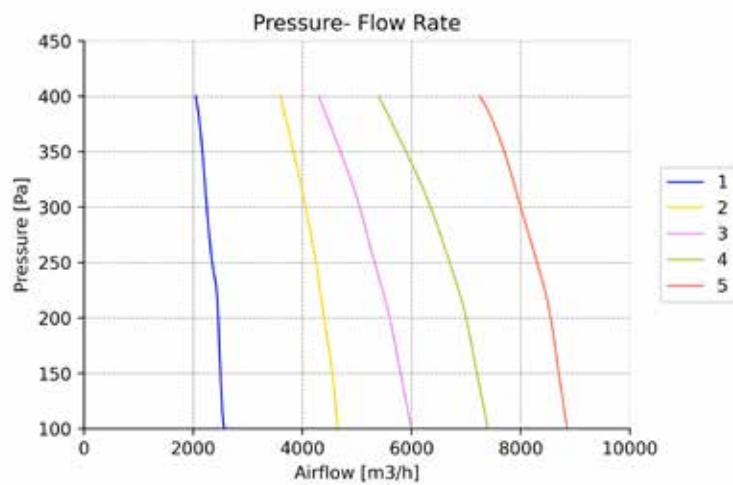

TECHNICAL PARAMETERS

MODEL	MODEL NUMBER	Voltage Frequency	Motor Power	Current	Rotation Speed	Sound Pressure	Protection Class	Working Range	Mass
		V-Hz	kW	A	RPM	Lp(A) dB at 3m	IP	°C	Kg
FOX C 200T	1	400-50	1,1	2,6	1400	57	54	-30/60	169
FOX C 360T	2	400-50	1,5	3,5	1400	63	54	-30/60	197
FOX C 430T	3	400-50	2,2	5	1400	66	54	-30/60	230
FOX C 540T	4	400-50	3	6,6	1400	76	54	-30/60	249
FOX C 720T	5	400-50	4	8,2	1400	78	54	-30/60	267

PRODUCT DIMENSIONS

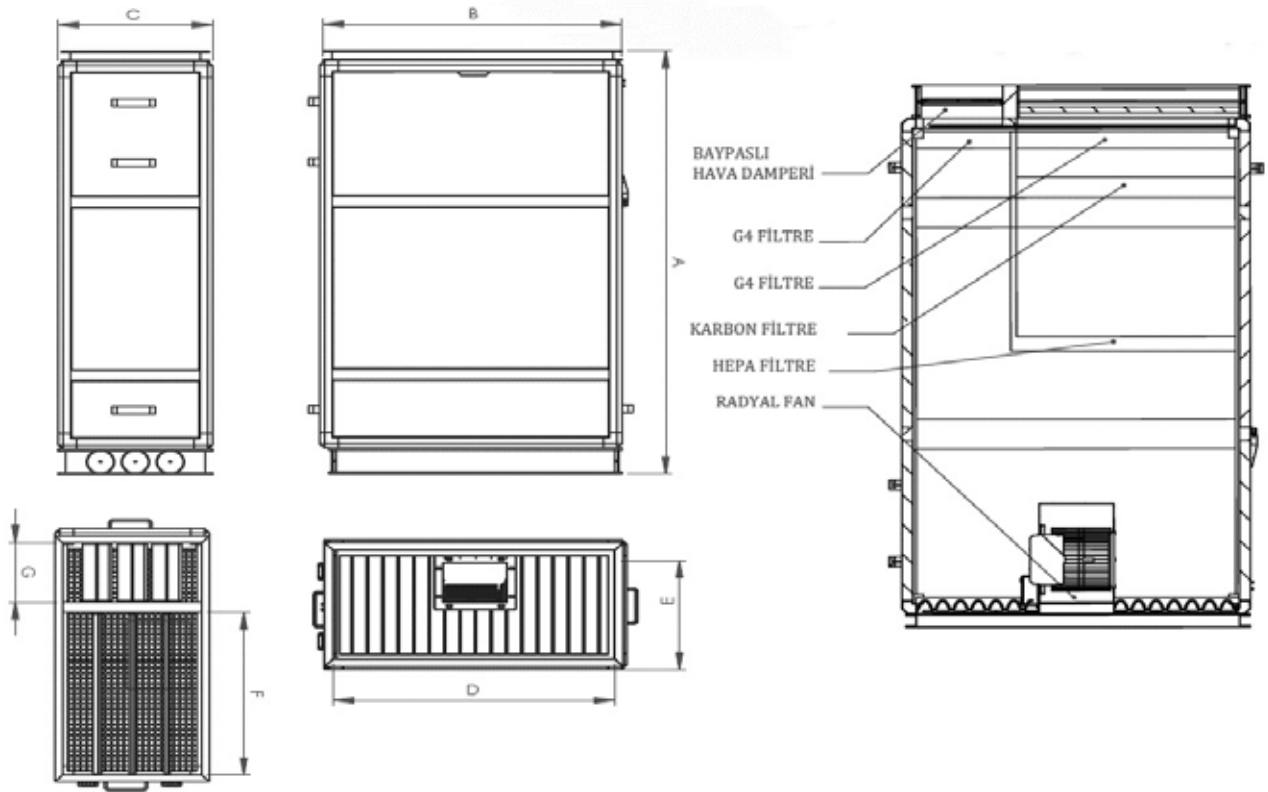

MODEL	A	B	C	D	E	F
FOX C 200T	2660	910	570	830	490	160
FOX C 360T	2760	1020	750	940	670	270
FOX C 430T	2860	1020	750	940	670	270
FOX C 540T	2960	1370	750	1290	670	270
FOX C 720T	3060	1670	850	1590	770	270

NOVVES

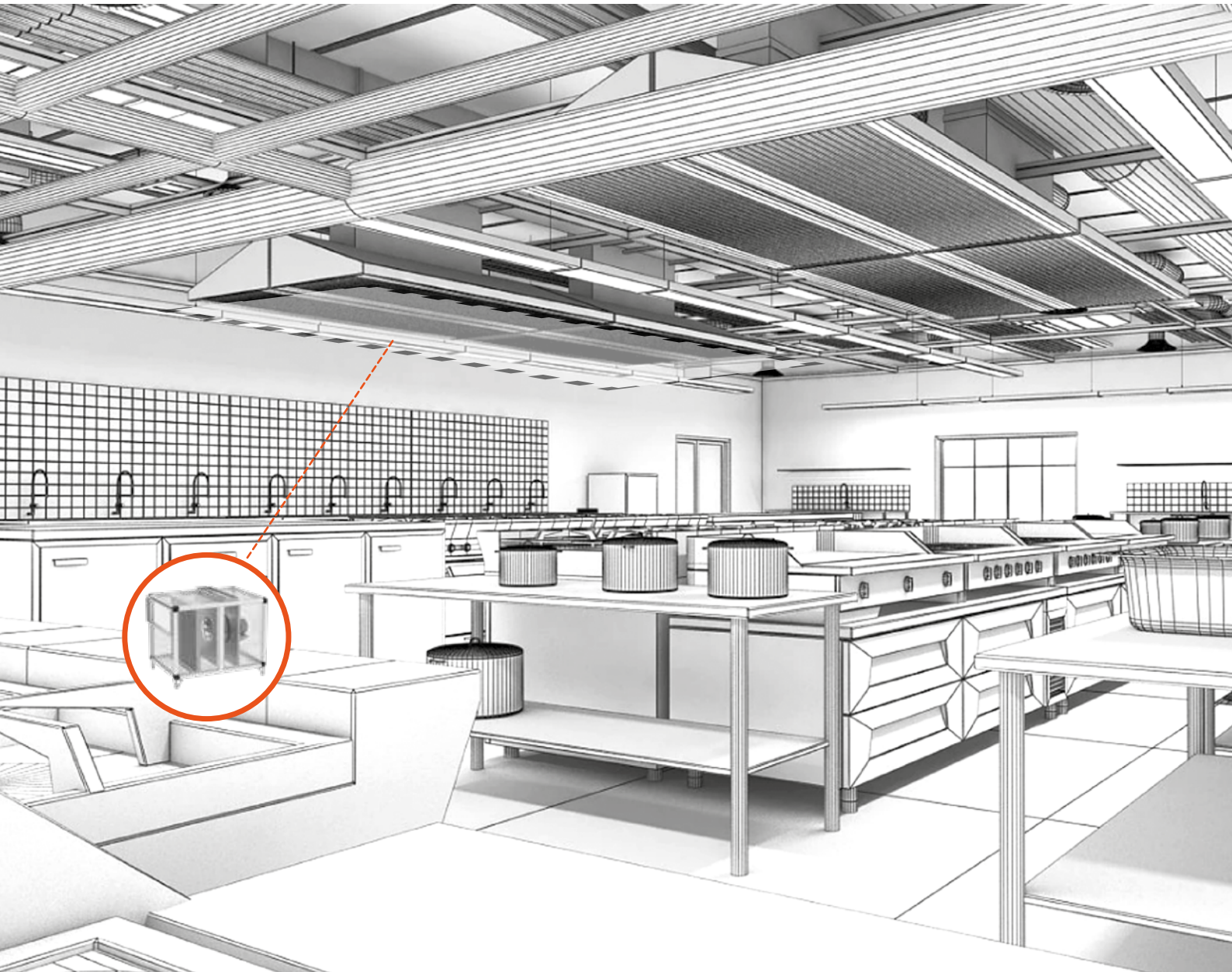

Butterfly
Kitchen Fan

BUTTERFLY SERIES



General

It is used to evacuate air in areas such as industrial kitchens where hot and oily air is intense. The air to be exhausted to the outside environment is purified from particles such as oil, thanks to the oil trap filter. Thanks to the intervention cover, the product can be cleaned and maintained effortlessly.

Body

The body, which is made of double-walled galvanized sheet with heat and sound insulation, is also available in galvanized options covered with electrostatic powder paint. It works silently thanks to insulation.

With the option to choose the direction of the air discharge and suction nozzles, unnecessary pressure losses are prevented and maximum efficiency is ensured. If it is used outdoors, roof accessories must be used.

Impeller

The fan blades are backward curved and sparsely designed, aerodynamically curved and provide regular flow. The propeller is dynamically balanced in accordance with ISO 1940.

Motor

Since the motor is out of the air flow, it is resistant to high temperature. All models are equipped with a three-phase asynchronous motor. The device is suitable to work with high performance at maximum 120°C.

IP Class

All models of this Series are in IP 55 protection, F insulation class.

Control

Fans can work directly with the help of MCC board. The speed can be adjusted by frequency inverter.

Fan Code

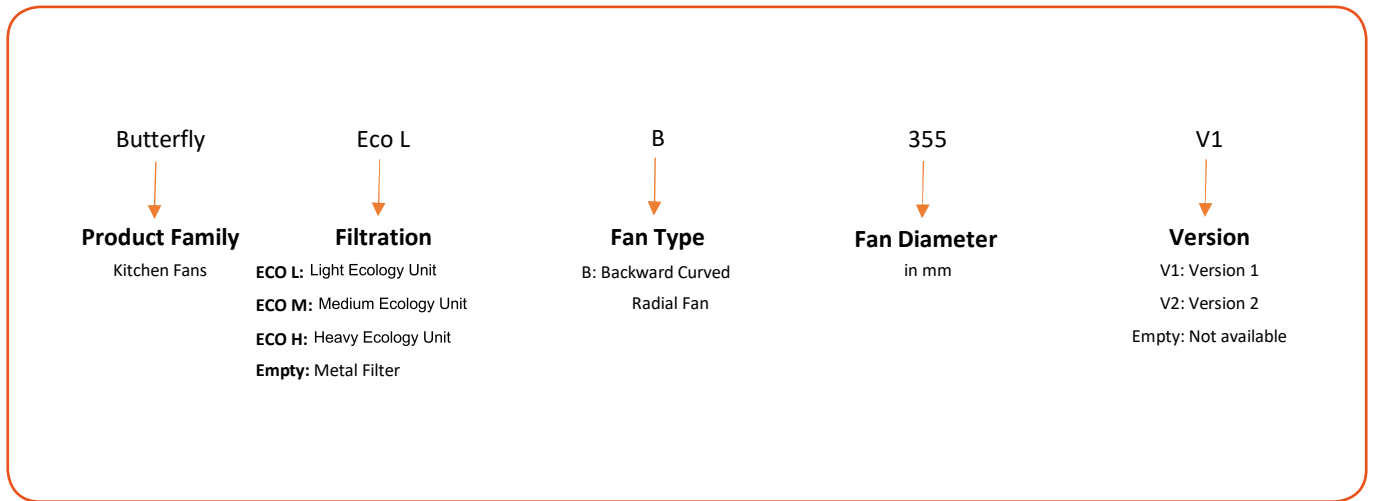

KITCHEN FANS WITH METAL FILTER



- Body manufactured from high quality galvanized sheet
- Double-walled, 20mm glass wool filling
- Motor outside the air stream
- Backward curved impeller
- Metal grease holder filter
- Rotational speed can be set with frequency inverter

BUTTERFLY B - SYSTEM CURVE

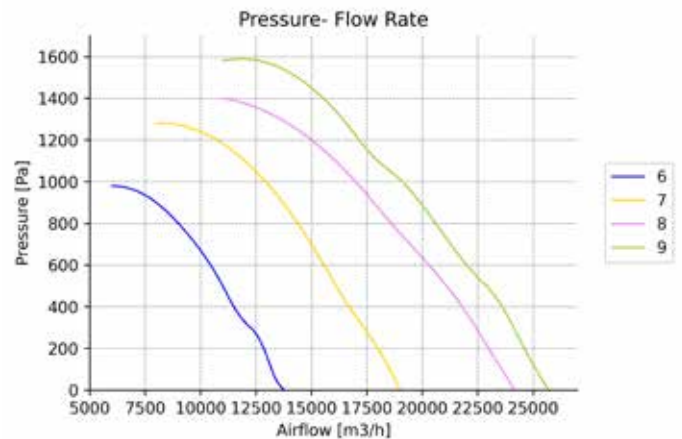
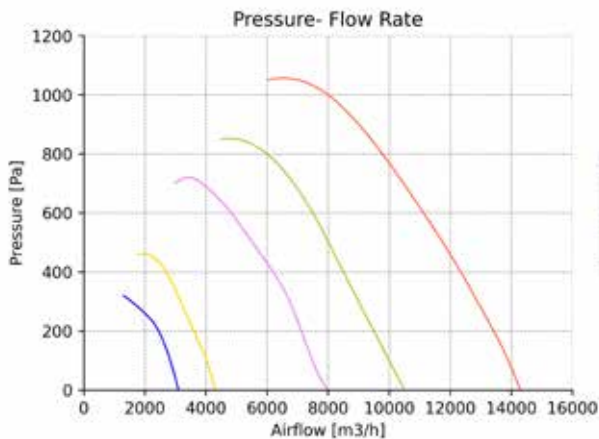

TECHNICAL PARAMETERS

MODEL	MODEL NUMBER	Voltage	Motor	Current	Rotation	Sound	Protection	Working	Mass
		Frequency	Power		Speed	Pressure	Class	Range	
		V-Hz	kW	A	RPM	Lp(A) dB at 3m	IP	°C	Kg
BUTTERFLY B 355	1	380-50	0,37	1,2	1450	60	55	-30/+120	57
BUTTERFLY B 400	2	380-50	0,75	2,1	1450	71	55	-30/+120	62
BUTTERFLY B 450	3	380-50	1,1	3,6	1450	75	55	-30/+120	69
BUTTERFLY B 500	4	380-50	1,5	5,3	1450	78	55	-30/+120	107
BUTTERFLY B 560 V1	5	380-50	2,2	6,6	1450	79	55	-30/+120	140
BUTTERFLY B 560 V2	6	380-50	3	8,7	1450	81	55	-30/+120	143
BUTTERFLY B 630	7	380-50	4	11,8	1450	83	55	-30/+120	193
BUTTERFLY B 710 V1	8	380-50	5,5	15,8	1450	85	55	-30/+120	212
BUTTERFLY B 710V2	9	380-50	7,5	22,5	1450	87	55	-30/+120	230

PRODUCT DIMENSIONS

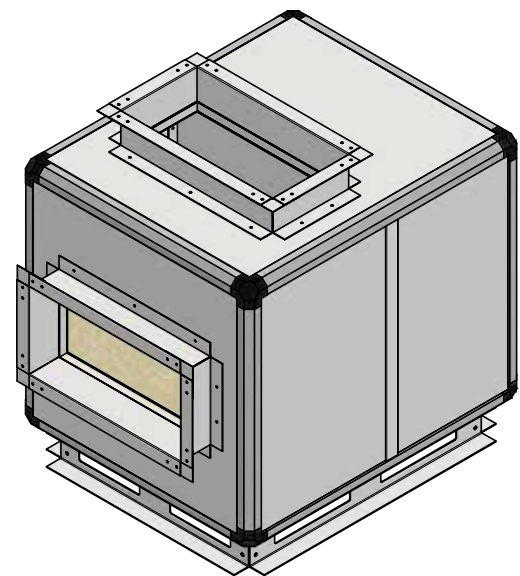
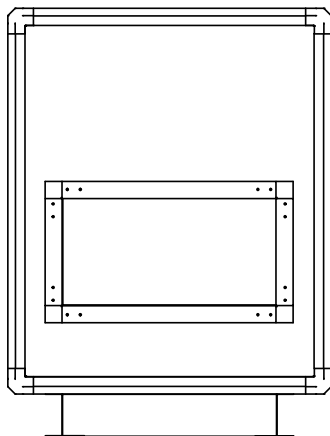
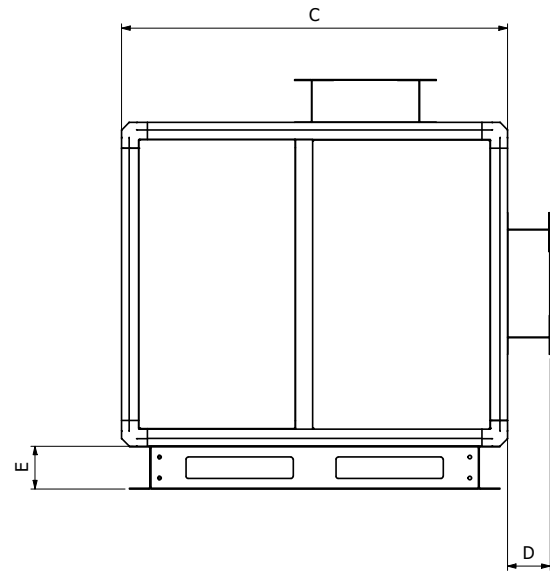
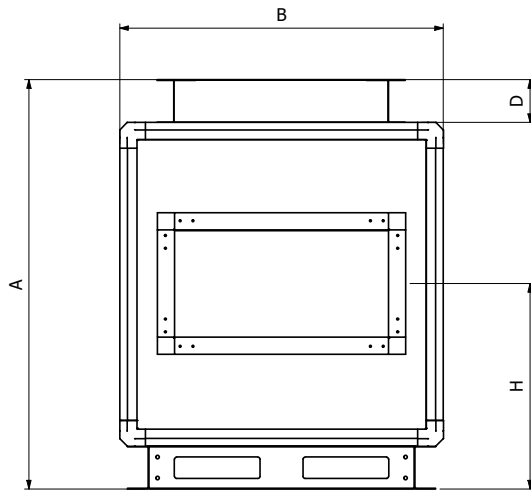

MODEL	A	B	C	D	E	H	Suction & Blowing Size
BUTTERFLY B 355	765	665	740	100	100	433	400x200
BUTTERFLY B 400	810	710	820	100	100	455	500x250
BUTTERFLY B 500	855	755	840	100	100	477	600x350
BUTTERFLY B 560V1	965	865	960	100	100	533	600x350
BUTTERFLY B 560V2	965	865	960	100	100	533	600x350
BUTTERFLY B 630	1090	990	1040	100	100	595	700x400
BUTTERFLY B 710V1	1140	1040	1220	100	100	620	800X500
BUTTERFLY B 710V2	1140	1040	1220	100	100	620	800X500

NOVVES

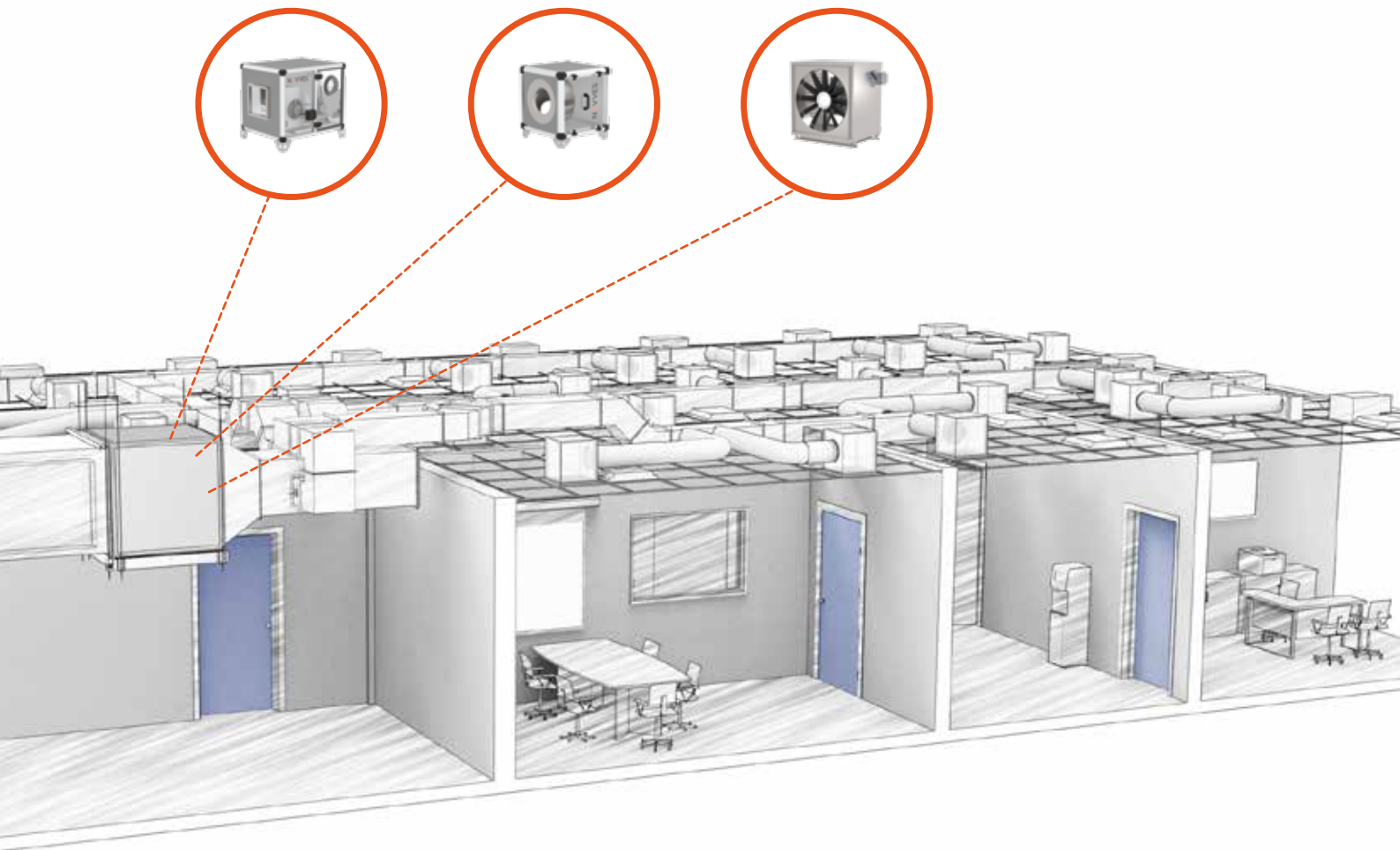

Turtle
Cabinet Fan

TURTLE SERIES**General**

Turtle Series fans can be used as fresh air fans and exhaust fans. With the intervention cover, the product can be cleaned and maintained effortlessly. Stone wool between the walls provides acoustic insulation. Due to its compact structure, it offers the opportunity to be mounted directly on the floor.

Body

The body, which is made of double-walled galvanized sheet with heat and sound insulation, is also available in galvanized options covered with electrostatic powder paint. It works silently thanks to insulation. In Turtle-B, BP series models, with the option to choose the direction of the air discharge and suction nozzles, unnecessary pressure losses are prevented and maximum efficiency is ensured. If it is used outdoors, roof accessories must be used.

Impeller

Turtle-B, BP series fan blades are backward curved and sparsely designed, aerodynamically curved and provide regular flow. The Turtle-A series is designed with aerodynamically optimized aerofoil axial blade. The core structure of the blade is made of aluminum alloy, and the blade are made of glass reinforced polypropylene. Propellers dynamically and statically balanced in accordance with ISO 1940.

Motor

Asynchronous motor is used. The device is suitable for operation up to a maximum of 50°C.

IP Class

All models of this series are in IP 55 protection, F insulation class.

Control

Turtle BP, A series models can work directly with the help of MCC board. Speed adjustment can be made with frequency inverter. Since Turtle B series has a belt and pulley system, the fan speed can be adjusted to meet the working conditions optimally.

Fan Code

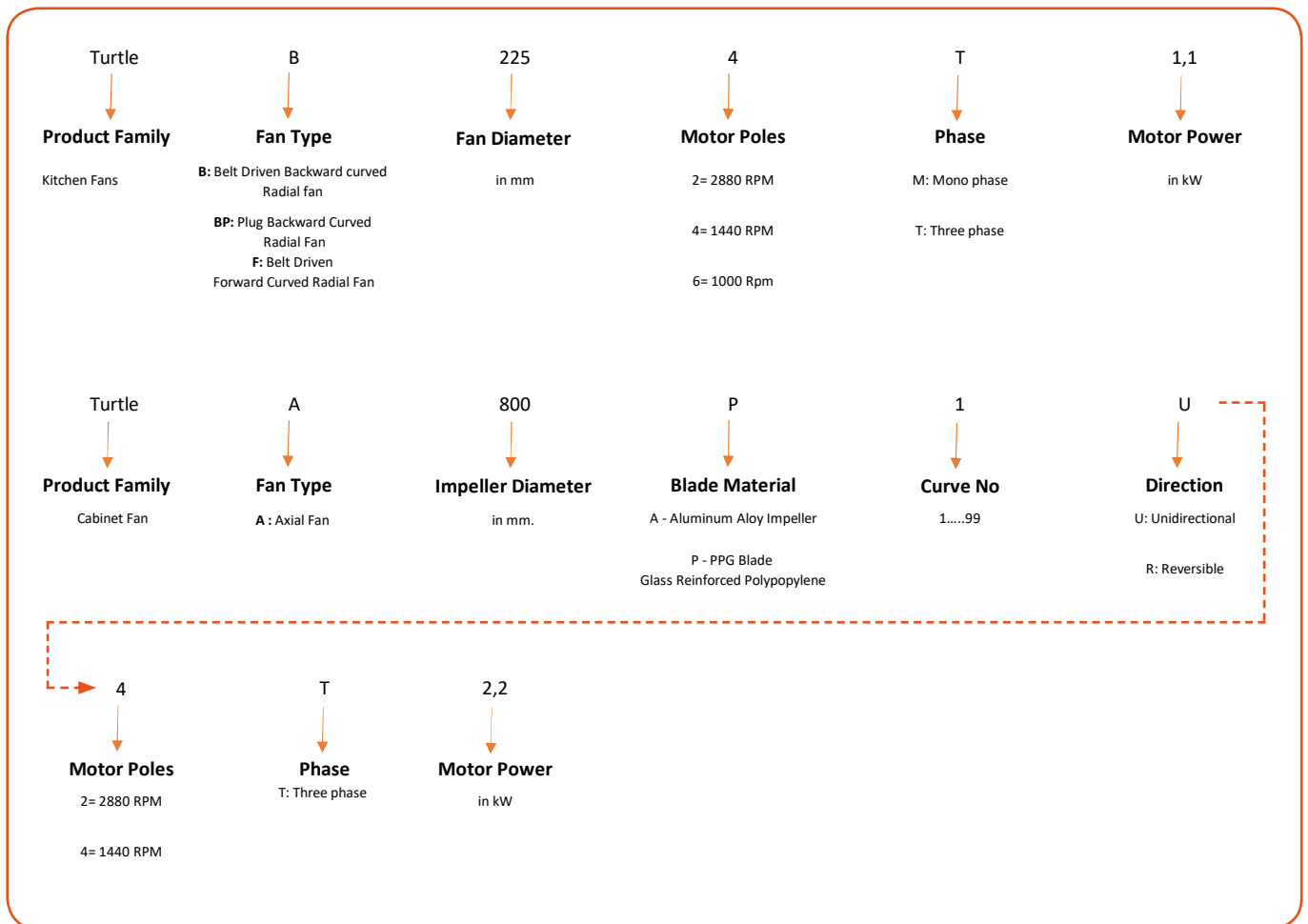

BELT DRIVEN BACKWARDS CURVED CABINET FANS



- Belt-drive fan
- Body manufactured from high quality galvanized sheet
- Double-walled cabinet, 20mm fiberglass insulation
- Backward curved impeller
- Rotational speed can be set with frequency inverter

TURTLE B - SYSTEM CURVE

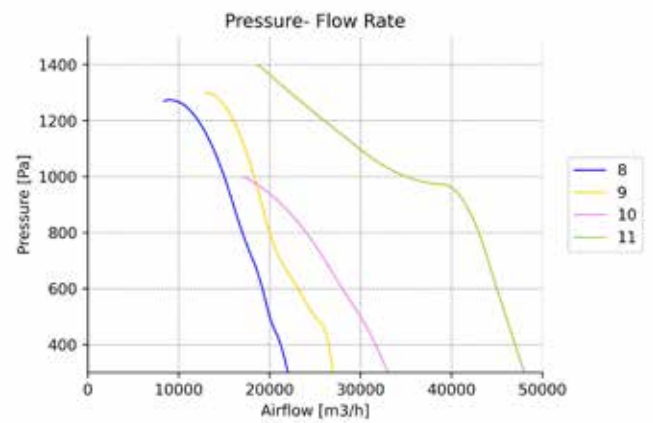
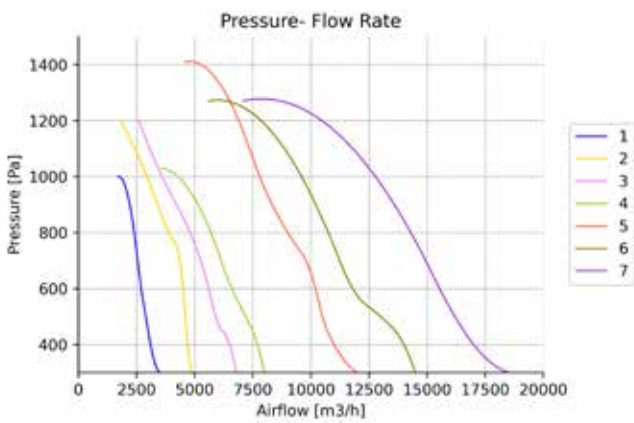

INLET - OUTLET CONNECTION OPTIONS

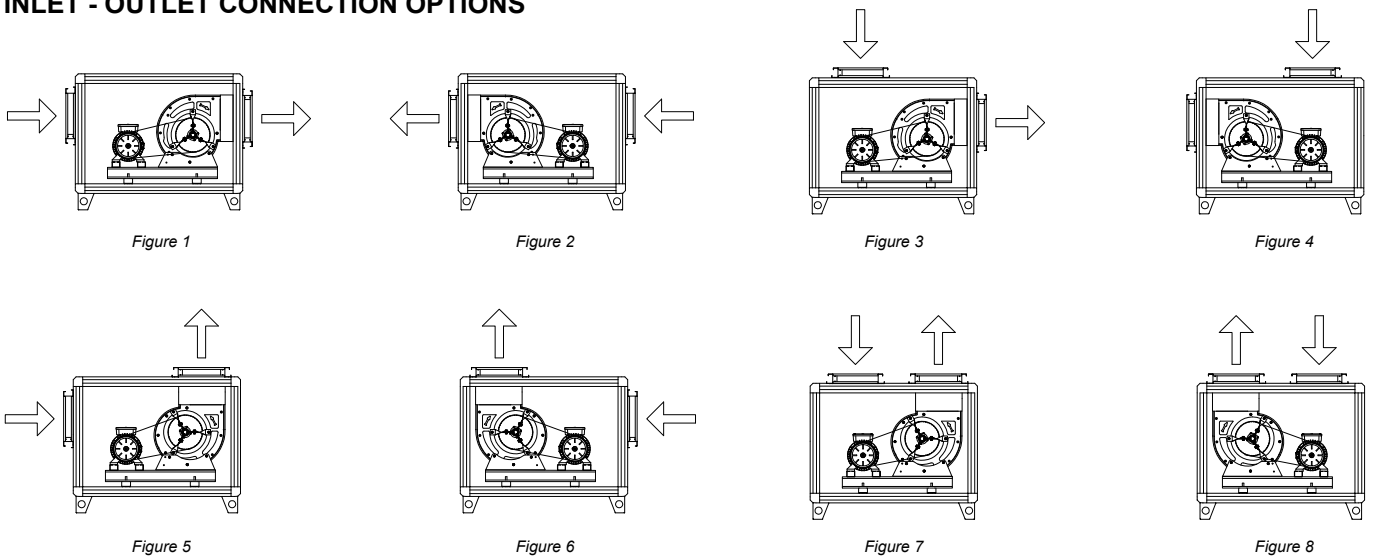

TECHNICAL PARAMETERS

MODEL	Model Number	Voltage	Frequency	Motor Power	Current	Rotation Speed	Sound Pressure	Protection Class	Working Range	Mass
		V	Hz	W	A	RPM	Lp(A) dB at 3m	IP	°C	Kg
TURTLE B 225 4T1,1	1	400	50	1,1	2,6	1420	48	55	-30/90	22
TURTLE B 250 4T1,5	2	400	50	1,5	3,5	1430	50	55	-30/90	30
TURTLE B 280 4T2,2	3	400	50	2,2	5	1435	51	55	-30/90	40
TURTLE B 315 4T3	4	400	50	3	6,6	1435	55	55	-30/90	65
TURTLE B 355 4T4	5	400	50	4	8,4	1455	58	55	-30/90	90
TURTLE B 400 4T4	6	400	50	4	8,4	1455	60	55	-30/90	112
TURTLE B 450 4T5,5	7	400	50	5,5	11,2	1465	62	55	-30/90	151
TURTLE B 500 4T7,5	8	400	50	7,5	15,4	1465	63	55	-30/90	160
TURTLE B 560 4T11	9	400	50	11	21,3	1465	66	55	-30/90	231
TURTLE B 630 4T11	10	400	50	11	21,3	1465	70	55	-30/90	271
TURTLE B 710 4T15	11	400	50	15	29,8	1465	78	55	-30/90	300

PRODUCT DIMENSIONS

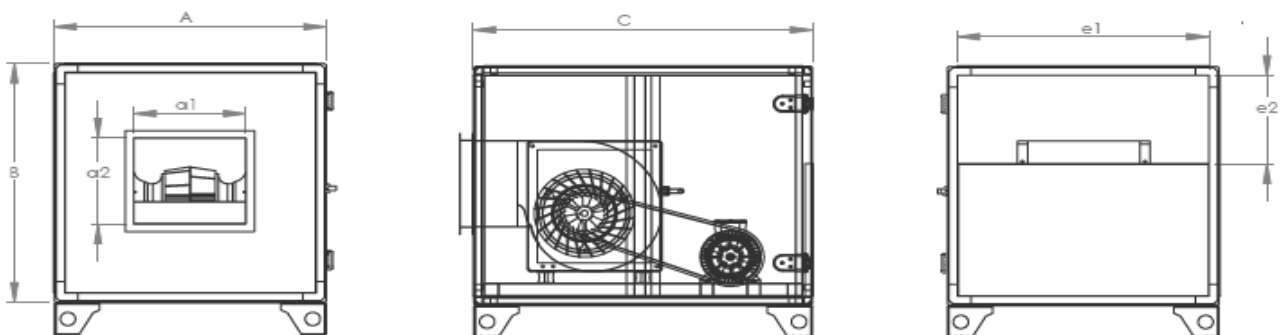

MODEL	A	B	C	a1	a2	e1	e2
TURTLE B 250	700	700	900	322	322	620	230
TURTLE B 280	800	800	1000	360	360	720	280
TURTLE B 315	900	900	1100	404	404	820	330
TURTLE B 355	1000	1000	1200	453	453	920	380
TURTLE B 400	1100	1100	1300	507	507	1020	430
TURTLE B 450	1200	1200	1400	570	570	1120	480
TURTLE B 500	1300	1300	1500	630	630	1220	530

PLUG BACKWARDS CURVED CABINET FANS

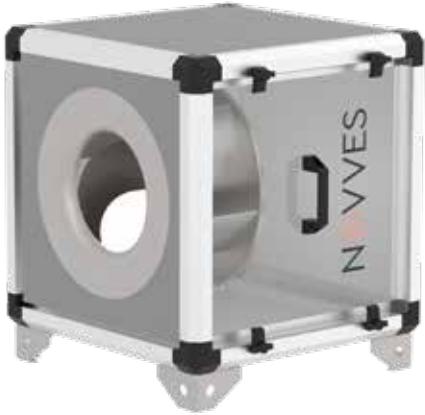

- Body manufactured from high quality galvanized sheet
- Double-walled cabinet, 20mm fiberglass insulation
- Backward curved impeller
- Rotational speed can be set with frequency inverter

TURTLE BP - SYSTEM CURVE

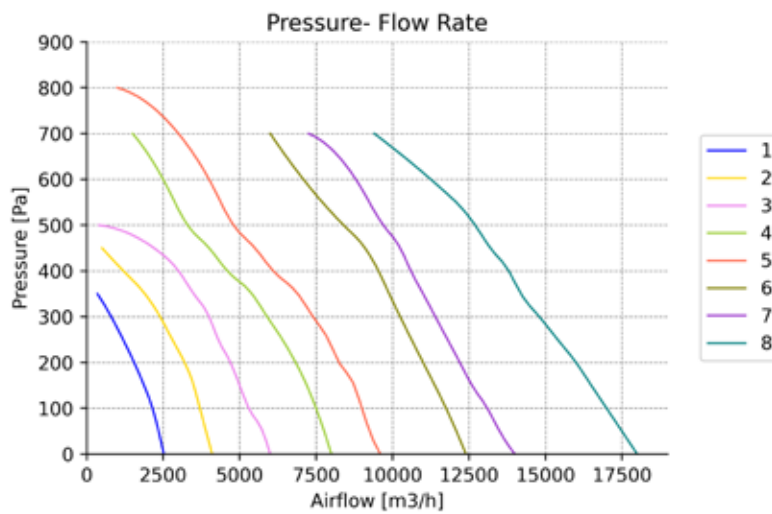

INLET - OUTLET CONNECTION OPTIONS

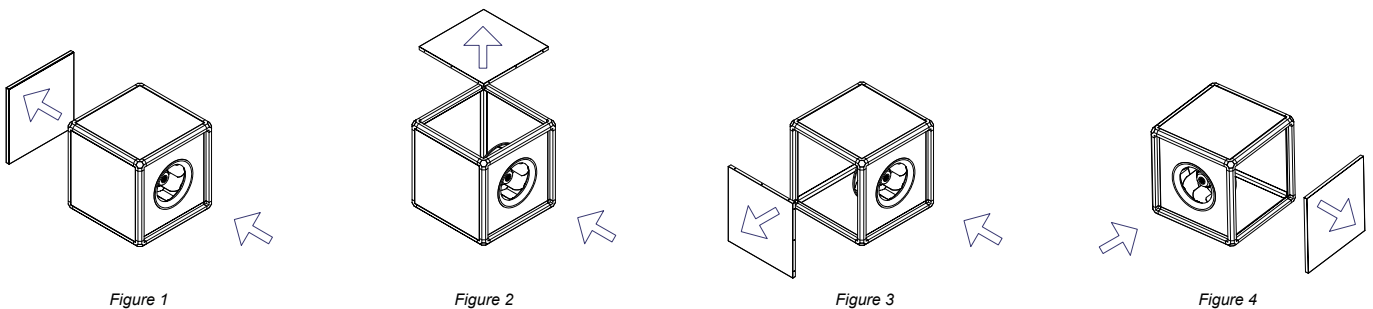

TECHNICAL PARAMETERS

MODEL	Model Number	Voltage	Frequency	Motor Power	Current	Rotation Speed	Sound Pressure	Protection Class	Working Range	Mass
		V	Hz	W	A	RPM	Lp(A) dB at 3m	IP	°C	Kg
TURTLE BP 355	1	230	50	0,21	1	1400	55	54	-30/60	61
TURTLE BP 400	2	230	50	0,43	1,5	1380	50	54	-30/60	93
TURTLE BP 450	3	230	50	0,8	3,5	1350	53	54	-30/60	100
TURTLE BP 500 V1	4	230	50	1,52	2,7	1400	54	54	-30/60	101
TURTLE BP 500 V2	5	230	50	1,5	2,6	1400	55	54	-30/60	123
TURTLE BP 560	6	230	50	2,74	4,58	1350	57	54	-30/60	141
TURTLE BP 630 V1	7	230	50	4,31	6,88	1334	67	54	-30/60	176
TURTLE BP 630 V2	8	230	50	4,31	6,88	1334	73	54	-30/60	208

PRODUCT DIMENSIONS

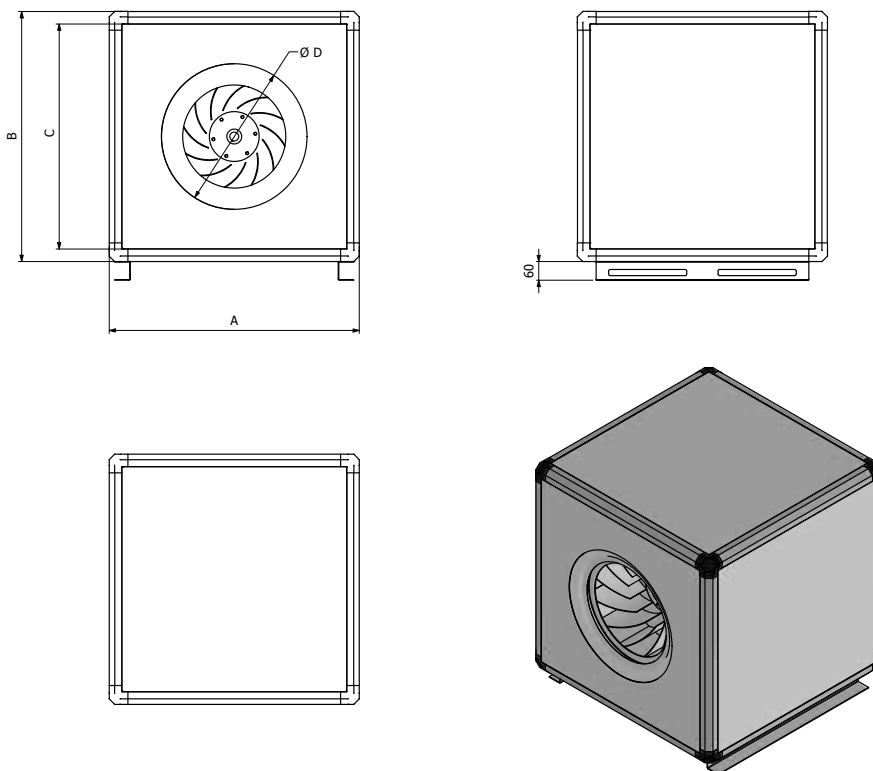

MODEL	A	B	C	D
TURTLE BP 355	500	500	520	330
TURTLE BP 400	670	670	590	375
TURTLE BP 450	670	670	590	420
TURTLE BP 500 V1	670	670	590	460
TURTLE BP 500 V2	800	800	720	460
TURTLE BP 560	800	800	720	520
TURTLE BP 630 V1	800	800	720	635
TURTLE BP 630 V2	1000	1000	920	635



PLUG FORWARDS CURVED CABINET FANS



- Double suction
- Low pressure forward curved radial impeller blades
- Body manufactured from galvanized sheet
- Monophase, 4-6 pole motors
- Suitable for speed controller
- 7”- 12” rotor diameter range

TURTLE F - SYSTEM CURVE

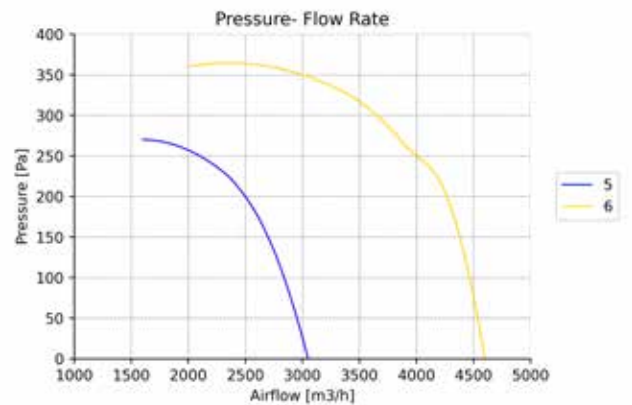
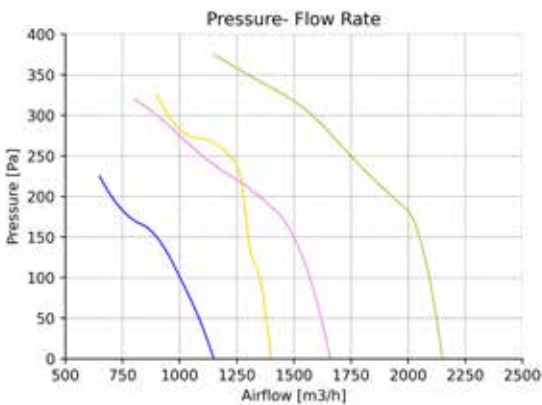

TECHNICAL PARAMETERS

MODEL	MODEL NUMBER	Voltage Frequency	Motor Power	Current	Rotation Speed	Sound Pressure	Protection Class	Working Range	Mass
		V-Hz	kW	A	RPM	Lp(A) dB at 3m	IP	°C	~ Kg
TURTLE F 7-7 4T0.15	1	220-50	0,15	1,4	1400	50	20	-10/40	6,7
TURTLE F 9-7 4T0.375	2	220-50	0,375	4	1400	69	20	-10/40	11,3
TURTLE F 9-9 4T0.45	3	220-50	0,45	5	1400	69	20	-10/40	12,4
TURTLE F 10-10 4T0.55	4	220-50	0,55	4,9	1400	63	20	-10/40	14,6
TURTLE F 12-12 6T0.75	5	220-50	0,75	5,9	970	69	20	-10/40	26,5
TURTLE F 12-12 6T1.27	6	220-50	1,27	7,7	960	73	20	-10/40	35

PRODUCT DIMENSIONS

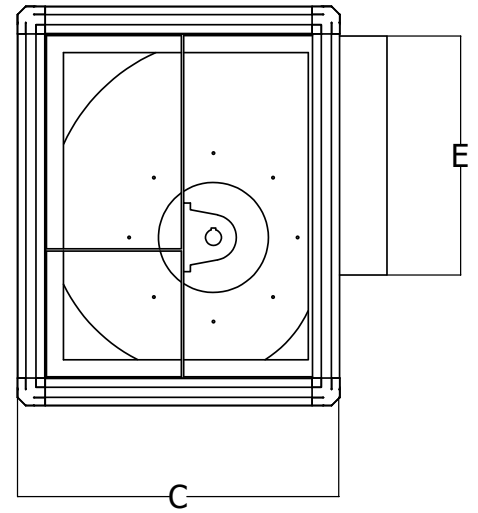
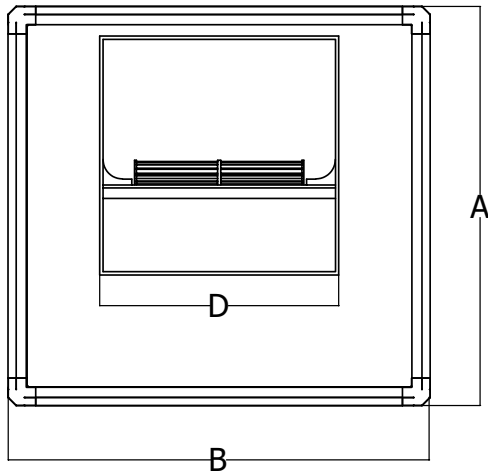

MODEL	A	B	C	D	E
TURTLE F 7-7 4T0.15	380	450	320	260	230
TURTLE F 9-7 4T0.375	450	485	380	260	280
TURTLE F 9-9 4T0.45	450	550	380	260	280
TURTLE F 10-10 4T0.55	510	595	420	360	310
TURTLE F 12-12 6T0.75	600	730	490	420	370
TURTLE F 12-12 6T1.27	600	730	490	420	370



AXIAL CABINET FANS



- Body is electrostatic powder painted for resistance to corrosion, optionally, body can be manufactured from hot dip galvanized sheet
- Double speed option
- Adjustable propeller angle
- Blade made of glass fiber composite materials
- Suitable for horizontal and vertical mounting
- The Fan can be used for fresh air or air exhaust up to 50°C
- Rotational speed can be set with frequency inverter

TURTLE A - SYSTEM CURVE - 2 POLES

Ø400 / 3-4-5 Blade

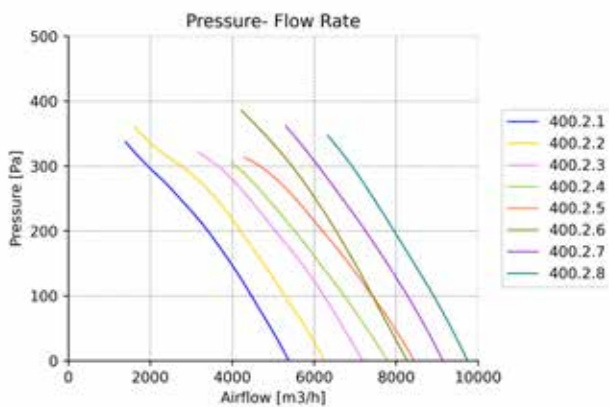

Ø400 / 6-8-10 Blade

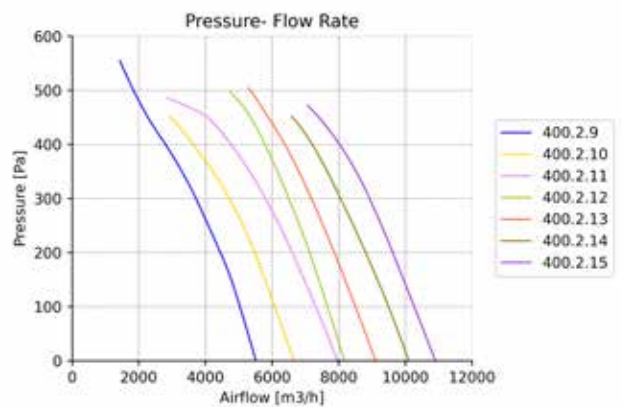

Ø450 / 3-4-6 Blade

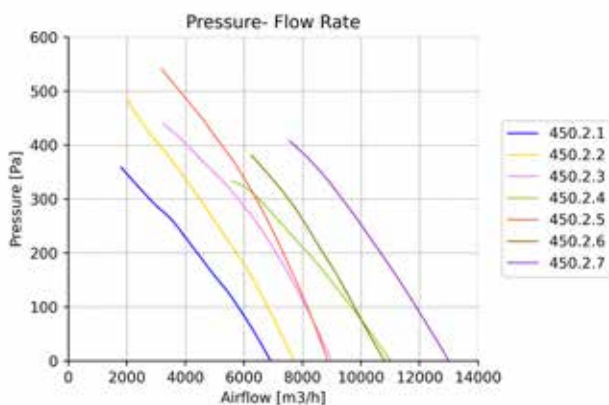

Ø450 / 5-6-8 Blade

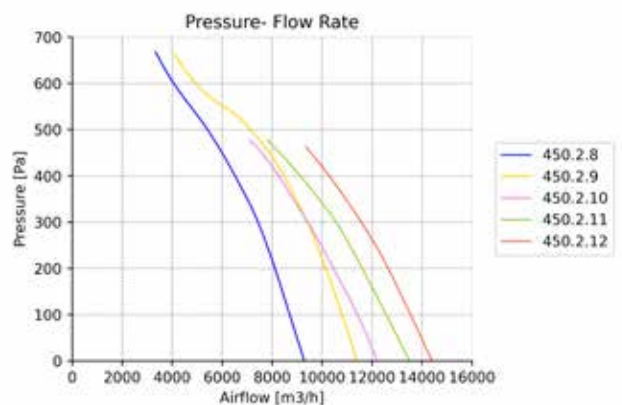

TURTLE A - SYSTEM CURVE - 2 POLES

Ø450 / 10 Blade

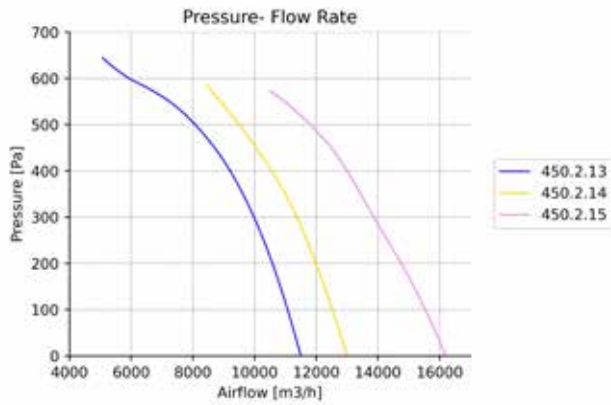

Ø500 / 3-4 Blade

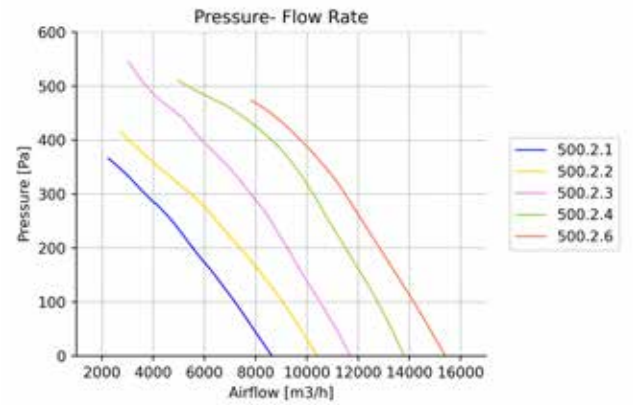

Ø500 / 5 Blade

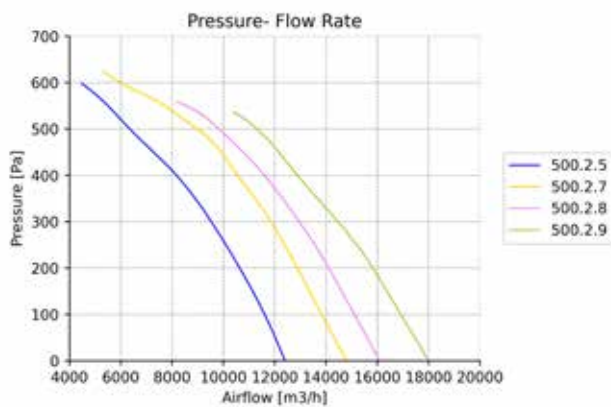

Ø500 / 10 Blade

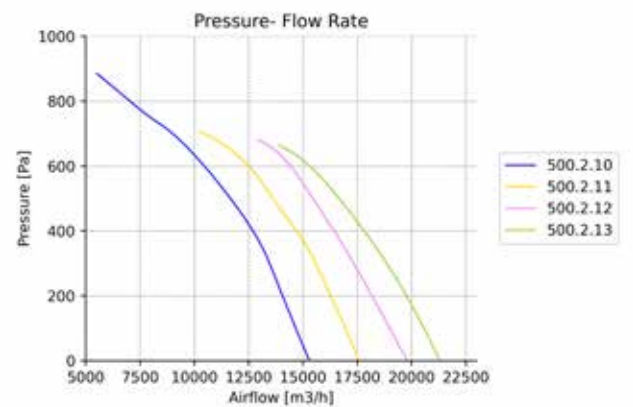

Ø560 / 3-4-5 Blade

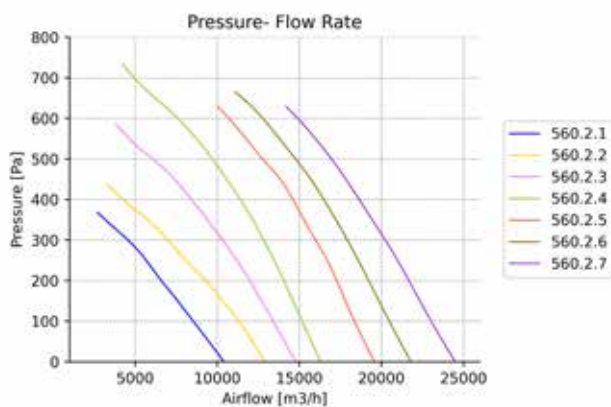

Ø560 / 6 Blade

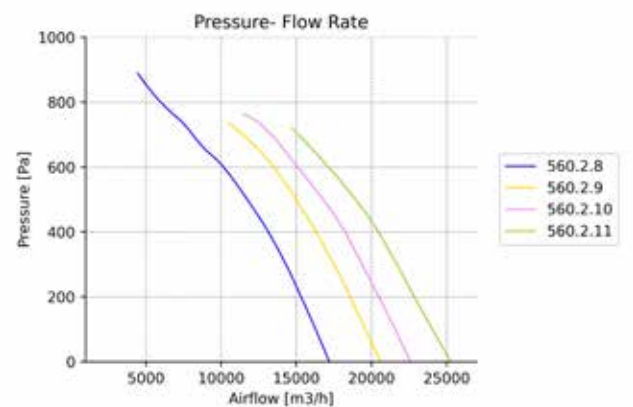

TURTLE A - SYSTEM CURVE - 2 POLES

Ø560 / 10 Blade

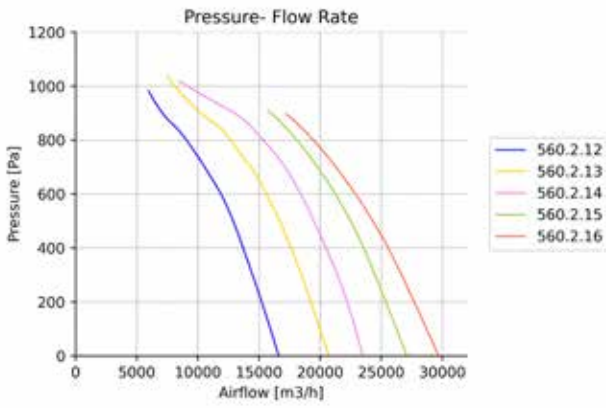

Ø630 / 3-4-5-6 Blade

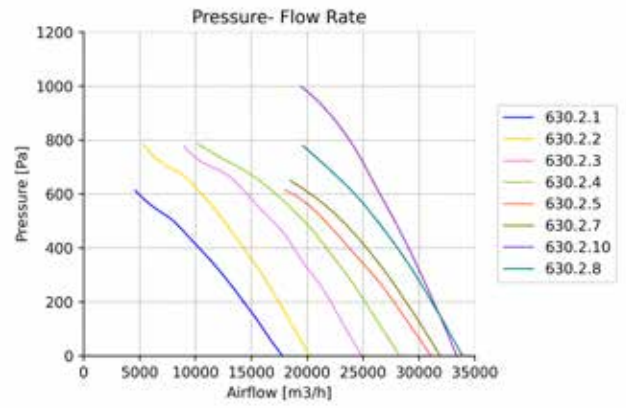

Ø630 / 6-10-12 Blade

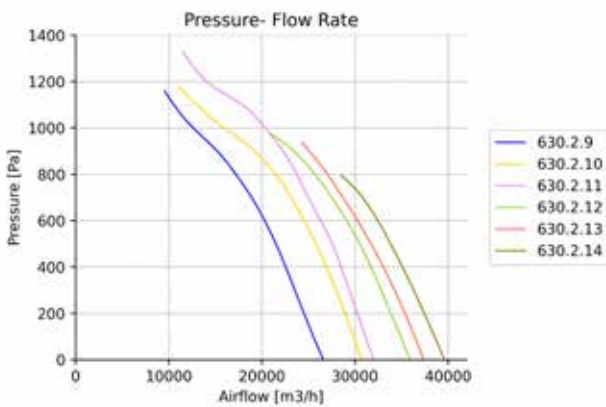

Ø710 / 3-6 Blade

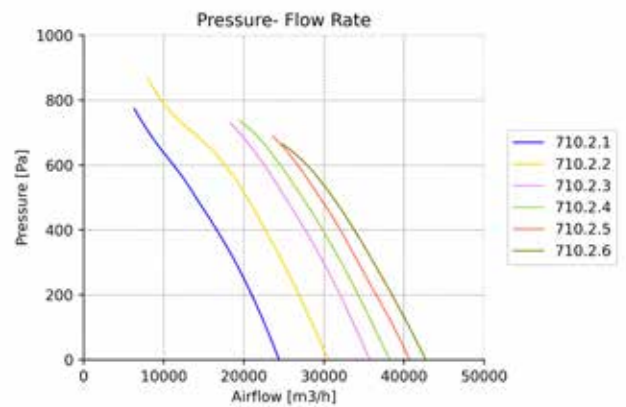

Ø710 / 6-12 Blade

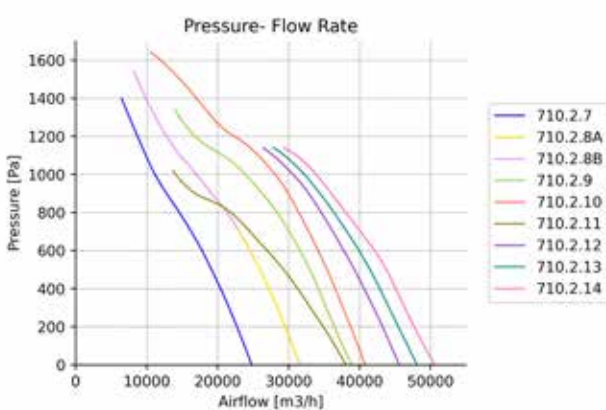

Ø800 / 3-6 Blade

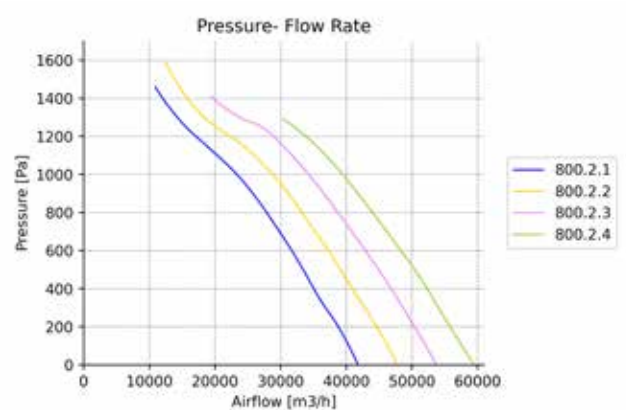

TURTLE A - SYSTEM CURVE - 2 POLES

Ø800 / 6-6 Blade

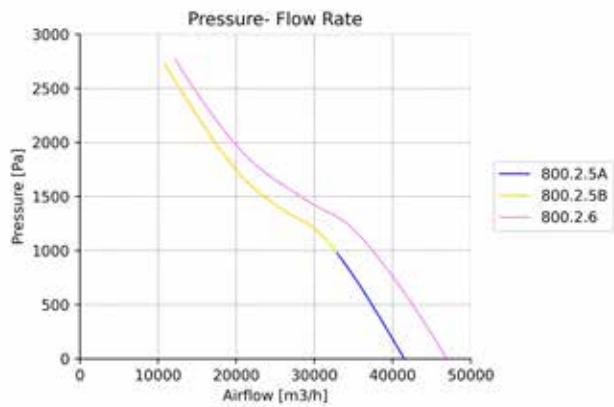

TURTLE A - SYSTEM CURVE - 4 POLES

Ø400 / 6-8 Blade

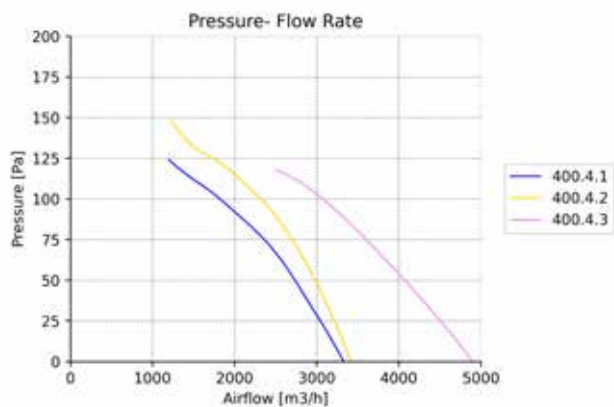

Ø450 / 6-8-10 Blade

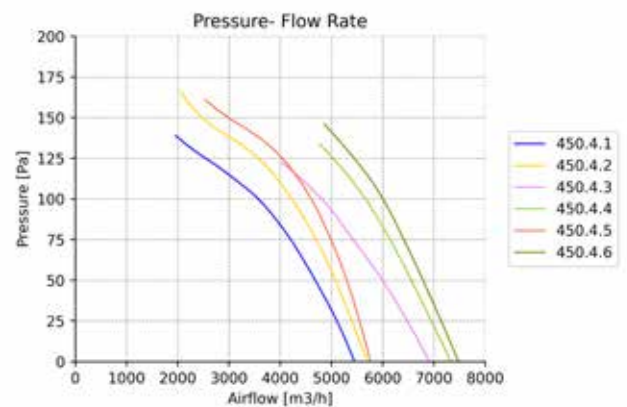

Ø500 / 6-8-10-12 Blade

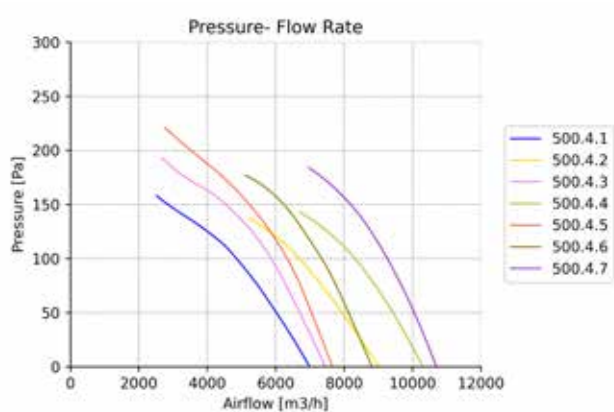

Ø560 / 3-4-6-8 Blade

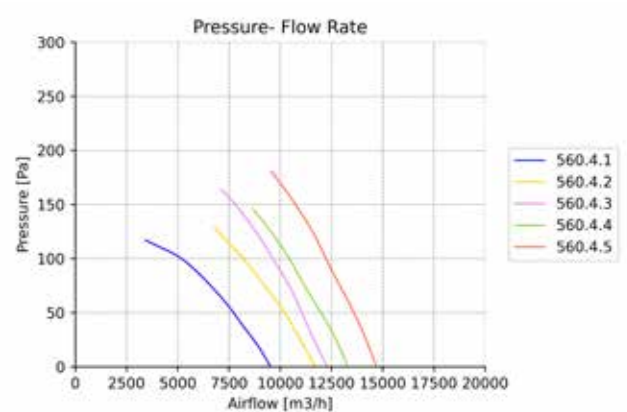

TURTLE A - SYSTEM CURVE - 4 POLES

Ø560 / 10-12 Blade

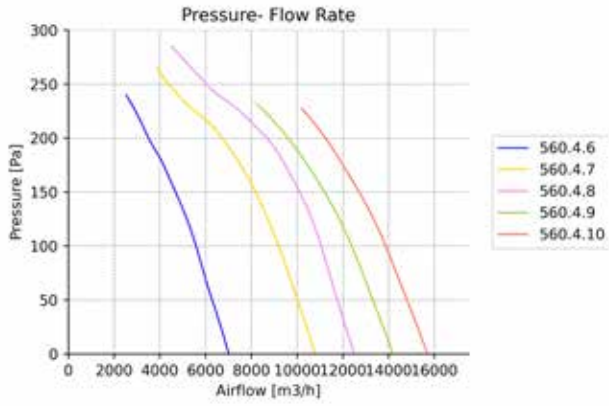

Ø630 / 5-6-8 Blade

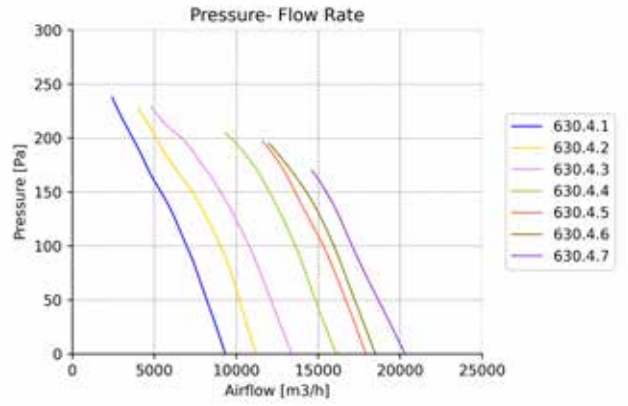

Ø630 / 10-12 Blade

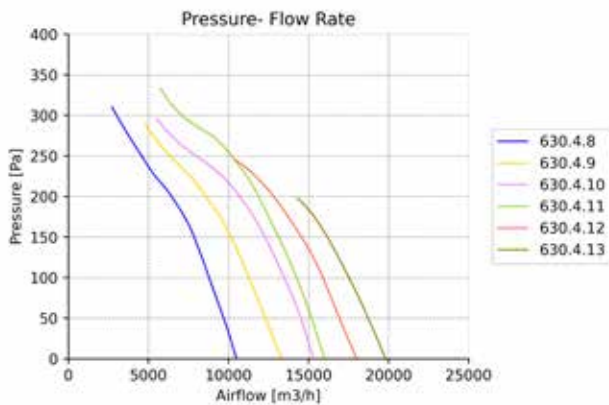

Ø630 / 9-12 Blade

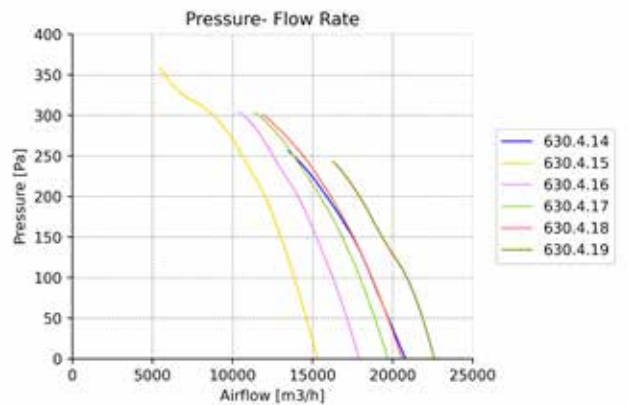

Ø710 / 5-6 Blade

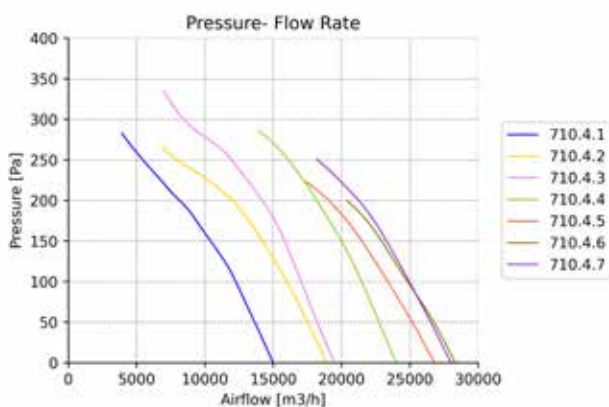

Ø710 / 9-12 Blade

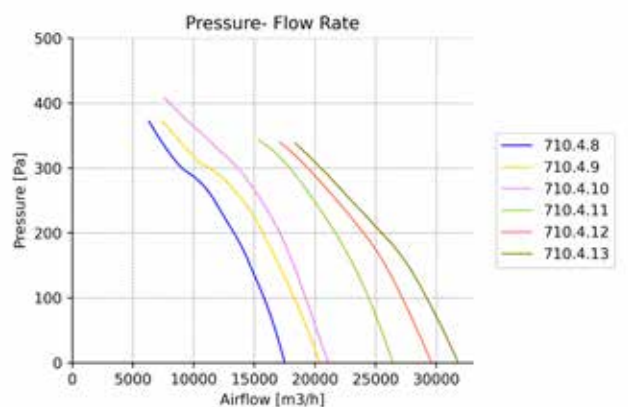

TURTLE A - SYSTEM CURVE - 4 POLES

Ø800 / 6 Blade

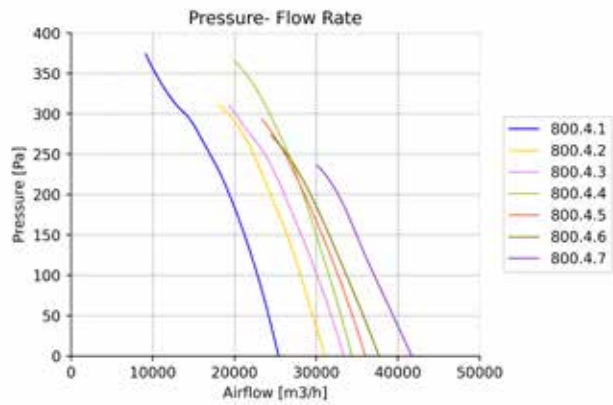

Ø800 / 8 Blade

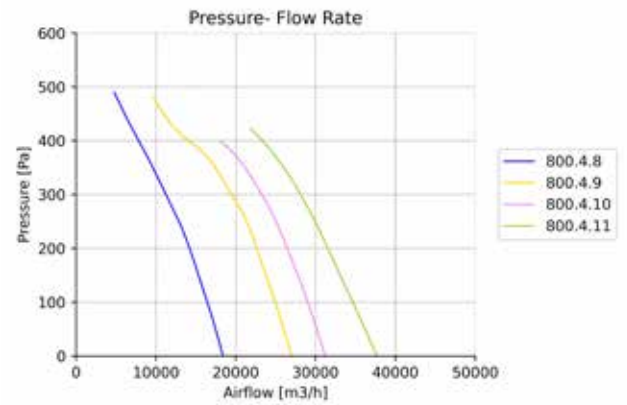

Ø800 / 9-12 Blade

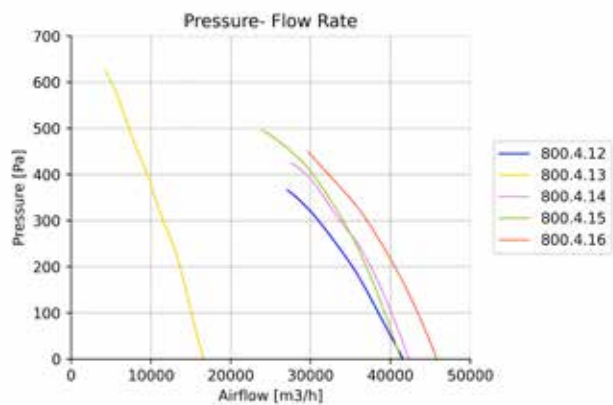

Ø800 / 6 Blade

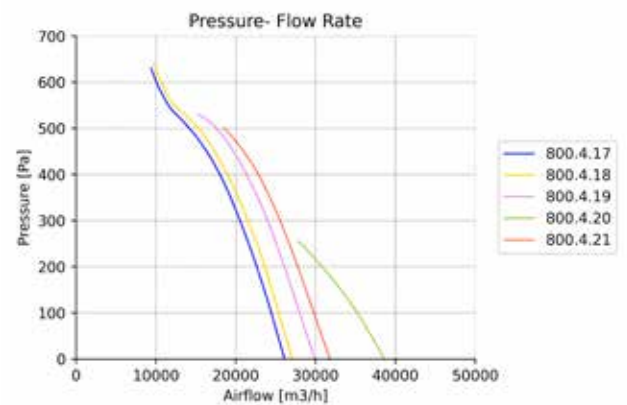

Ø900 / 6 Blade

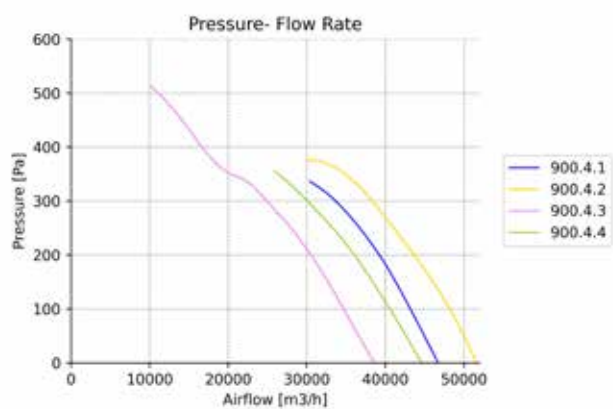

Ø900 / 8 Blade

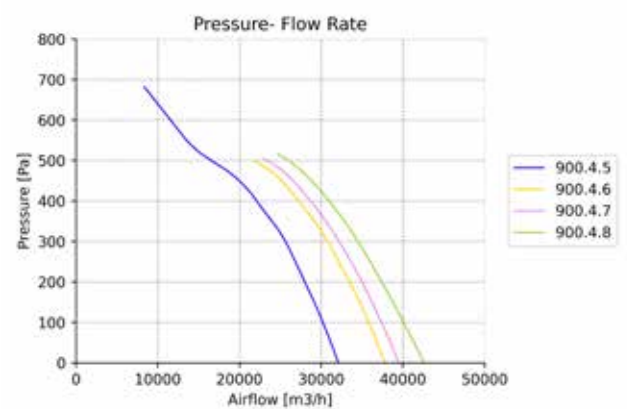

TURTLE A - SYSTEM CURVE - 4 POLES

Ø900 / 9 Blade

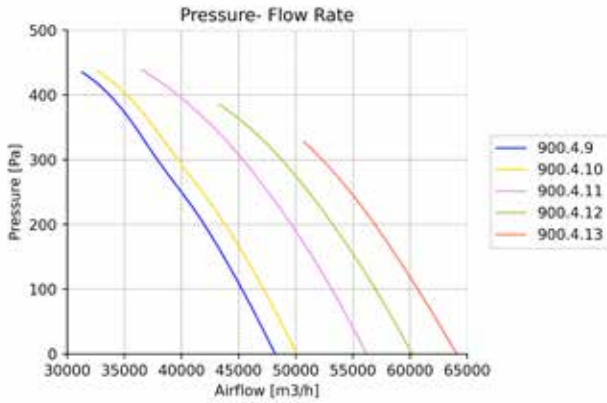

Ø900 / 12 Blade

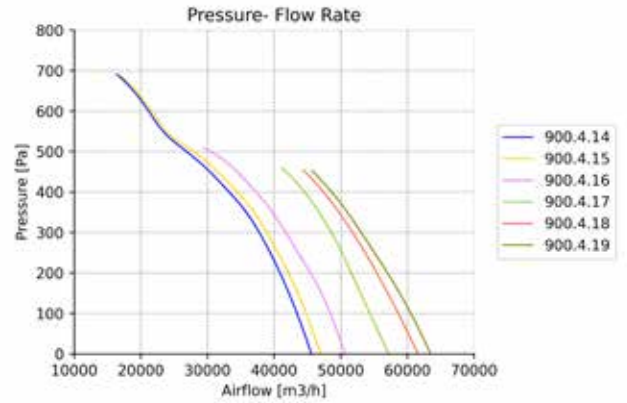

Ø900 / 6 Blade

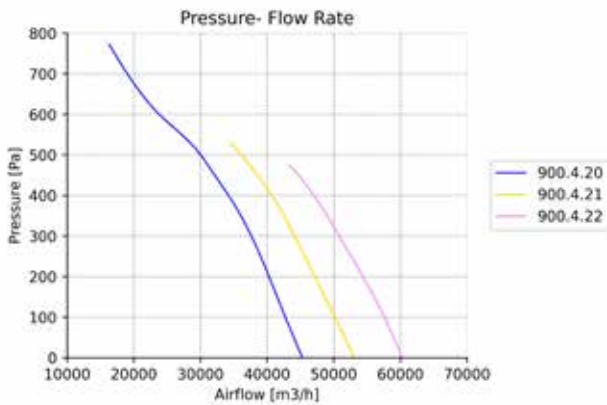

Ø1000 / 3 Blade

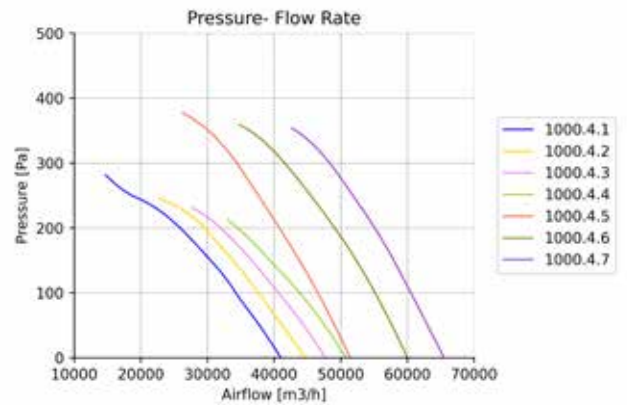

Ø1000 / 5-6 Blade

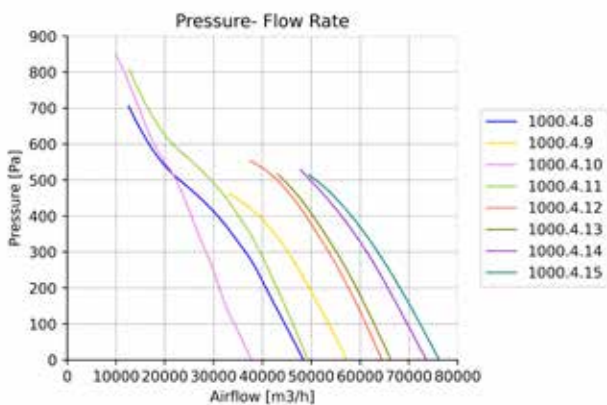

Ø1000 / 6 Blade

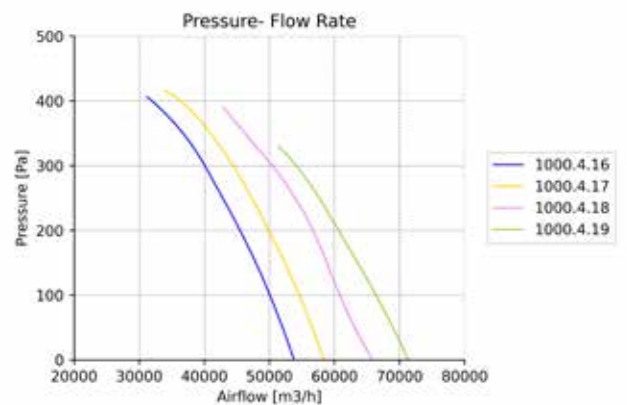

TURTLE A - SYSTEM CURVE - 4 POLES

Ø1000 / 6 Blade

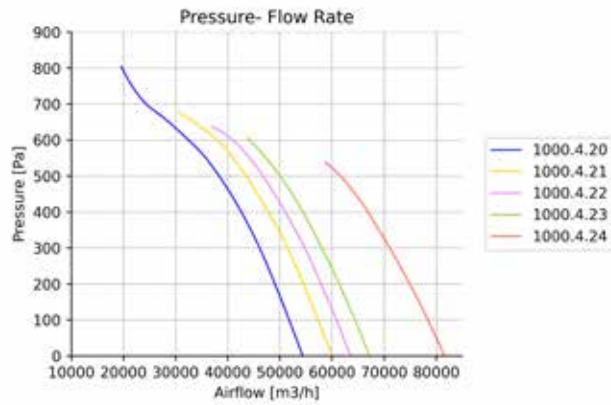

Ø1000 / 8 Blade

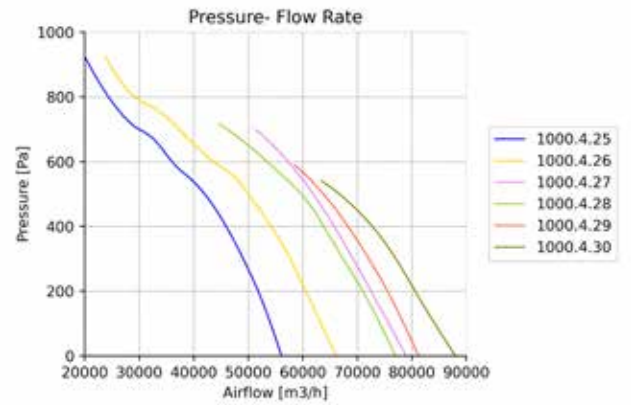

Ø1000 / 9 Blade

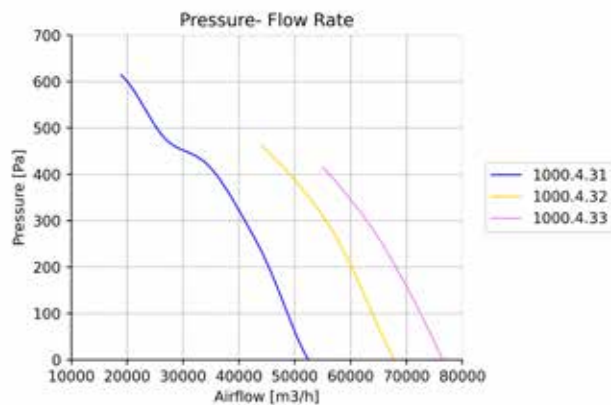

Ø1000 / 10 Blade

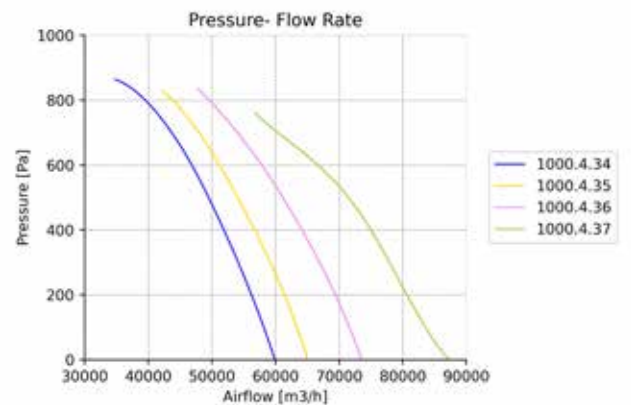

Ø1120 / 3 Blade

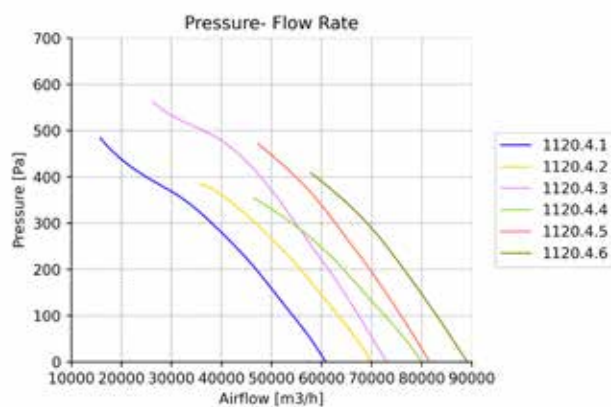

Ø1120 / 6 Blade

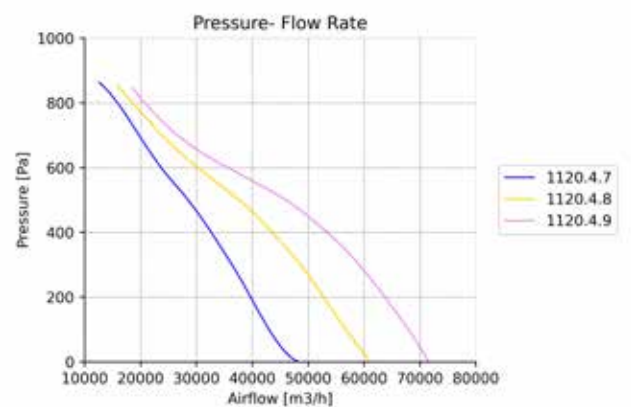

TURTLE A - SYSTEM CURVE - 4 POLES

Ø1120 / 6 Blade

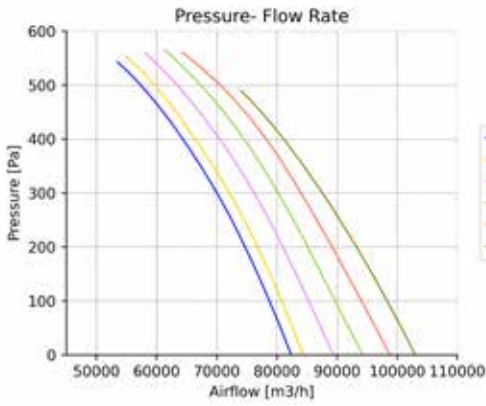

Ø1120 / 6 Blade

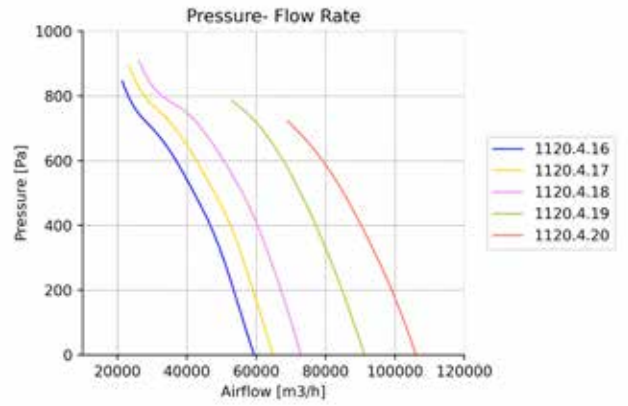

Ø1120 / 8 Blade

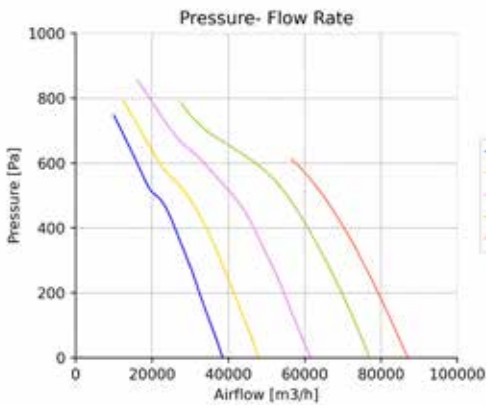

Ø1120 / 8 Blade

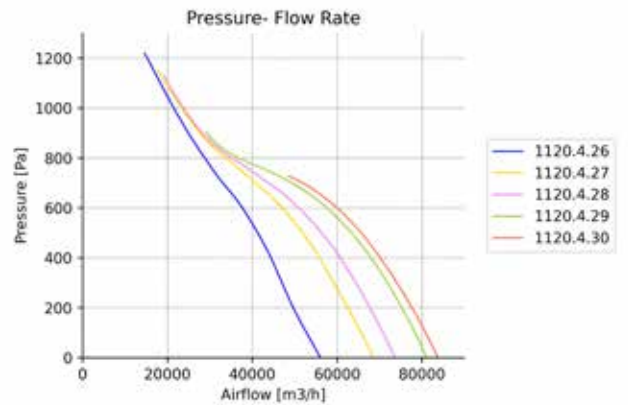

Ø1120 / 8 Blade

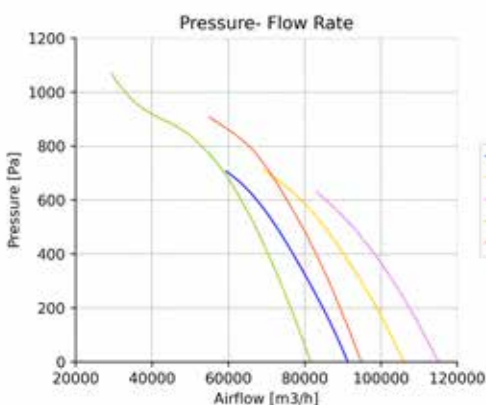

Ø1120 / 10-12 Blade

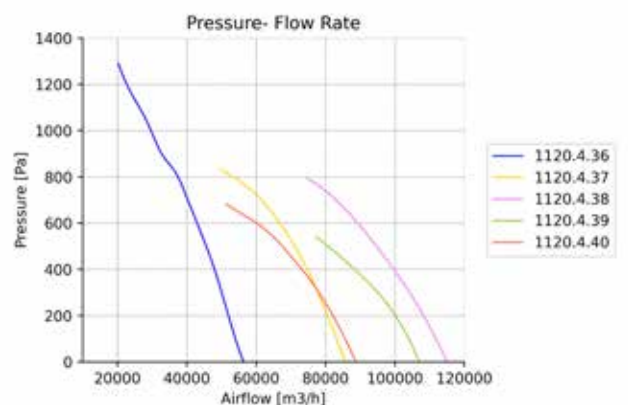

TURTLE A - SYSTEM CURVE - 4 POLES

Ø1250 / 3 Blade

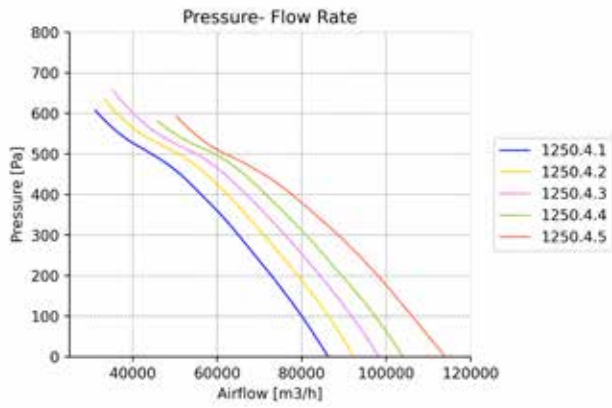

Ø1250 / 6 Blade

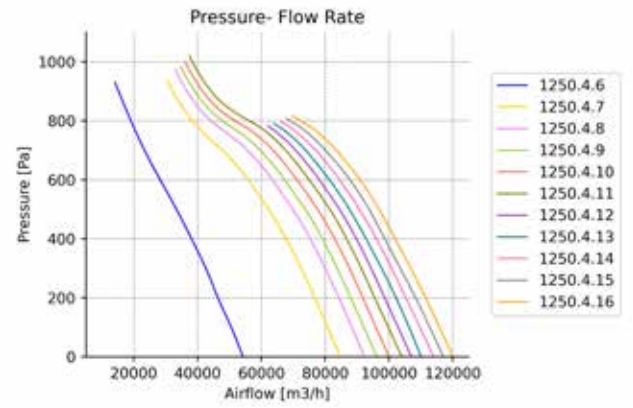

Ø1250 / 6 Blade

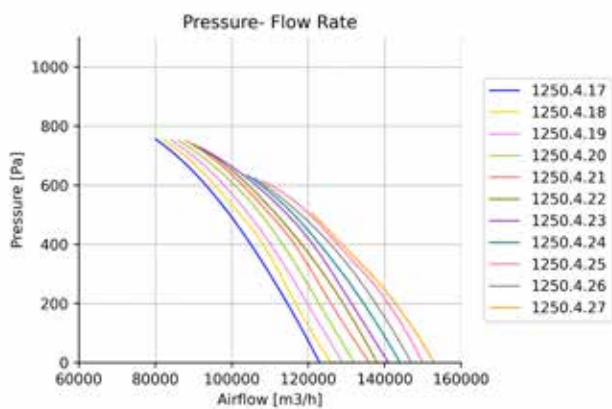

Ø1250 / 8 Blade

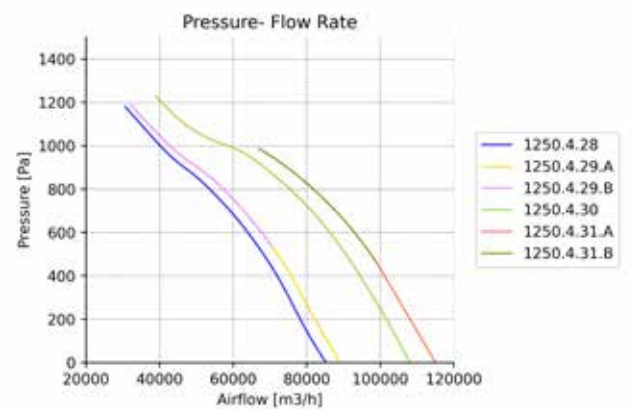

Ø1250 / 8 Blade

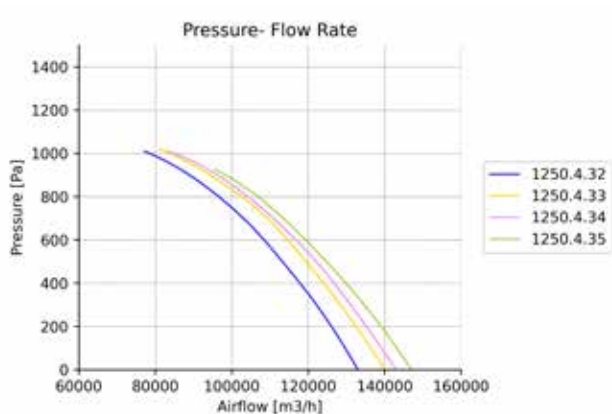

Ø1250 / 5 Blade

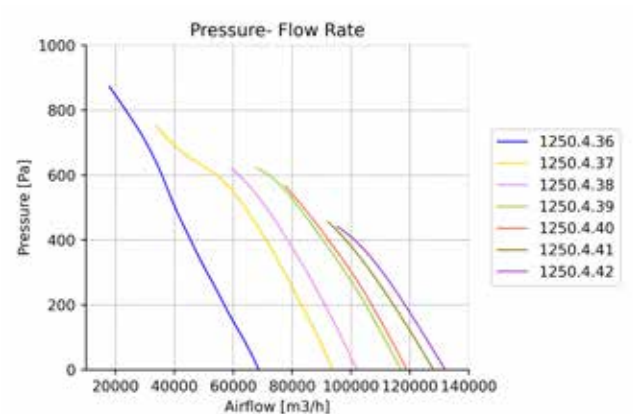

PRODUCT DIMENSIONS

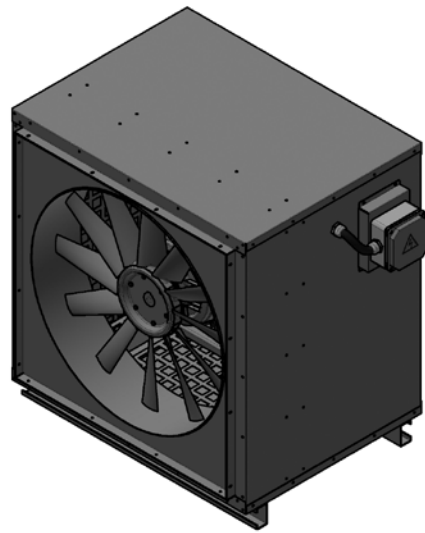
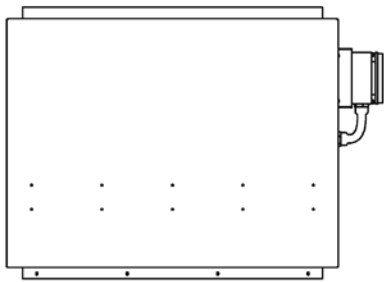
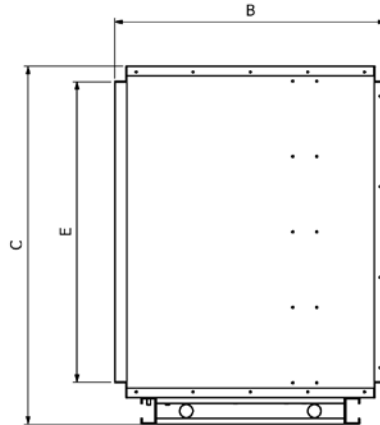
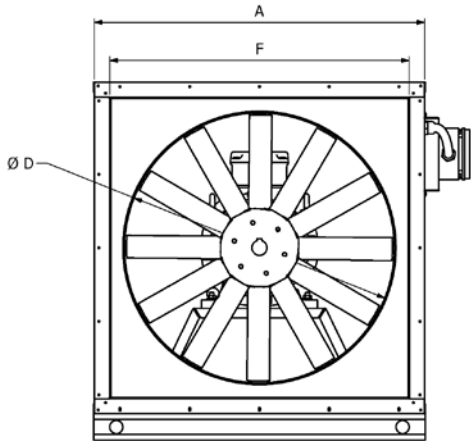

MODEL	A	B	C	ØD	E	F
TURTLE A 400	670	600	740	400	590	590
TURTLE A 450	670	600	740	450	590	590
TURTLE A 500	670	600	740	500	590	590
TURTLE A 560	800	650	870	560	720	720
TURTLE A 630	800	650	870	630	720	720
TURTLE A 710	880	720	950	710	800	800
TURTLE A 800	970	720	1040	800	890	890
TURTLE A 900	1170	800	1270	900	1070	1070
TURTLE A 1000	1170	800	1270	1000	1070	1070
TURTLE A 1120	1420	1000	1520	1120	1320	1320
TURTLE A 1250	1420	1000	1520	1250	1320	1320

TECHNICAL PARAMETERS

MODEL	MODEL NUMBER	Voltage Frequency	Motor Power	Current	Rotation Speed	Sound Pressure	Protection Class	Working Range	Mass
		V-Hz	kW	A	RPM	Lp(A) dB at 3m	IP	°C	~ Kg
TURTLE A 400P1U-2T0,37	400.2.1	400-50	0,37	1,5	2880	60,5	55	-20/+50	66
TURTLE A 400P2U-2T0,55	400.2.2	400-50	0,55	1,6	2880	58,5	55	-20/+50	67
TURTLE A 400P3U-2T0,75	400.2.3	400-50	0,75	1,7	2880	59,8	55	-20/+50	69
TURTLE A 400P4U-2T0,75	400.2.4	400-50	0,75	1,7	2880	60,6	55	-20/+50	69
TURTLE A 400P5U-2T1,1	400.2.5	400-50	1,1	2,3	2880	63,2	55	-20/+50	69
TURTLE A 400P6U-2T1,1	400.2.6	400-50	1,1	2,3	2880	60,5	55	-20/+50	70
TURTLE A 400P7U-2T1,5	400.2.7	400-50	1,5	3,3	2880	63	55	-20/+50	72
TURTLE A 400P8U-2T2,2	400.2.8	400-50	2,2	4,5	2880	65,4	55	-20/+50	75
TURTLE A 400P9U-2T0,75	400.2.9	400-50	0,75	1,7	2880	63,6	55	-20/+50	69
TURTLE A 400P10U-2T0,75	400.2.10	400-50	0,75	1,7	2880	61,6	55	-20/+50	69
TURTLE A 400P11U-2T1,1	400.2.11	400-50	1,1	2,3	2880	60,2	55	-20/+50	69
TURTLE A 400P12U-2T1,5	400.2.12	400-50	1,5	3,3	2880	61,4	55	-20/+50	72
TURTLE A 400P13U-2T1,5	400.2.13	400-50	1,5	3,3	2880	61,2	55	-20/+50	72
TURTLE A 400P14U-2T2,2	400.2.14	400-50	2,2	4,5	2880	61,5	55	-20/+50	75
TURTLE A 400P15U-2T3	400.2.15	400-50	3	5,9	2880	64,3	55	-20/+50	82
TURTLE A 450P1U-2T0,55	450.2.1	400-50	0,55	1,6	2880	64	55	-20/+50	74
TURTLE A 450P2U-2T0,75	450.2.2	400-50	0,75	1,7	2880	67,9	55	-20/+50	76
TURTLE A 450P3U-2T1,1	450.2.3	400-50	1,1	2,3	2880	62,9	55	-20/+50	77
TURTLE A 450P4U-2T1,1	450.2.4	400-50	1,1	2,3	2880	64,3	55	-20/+50	76
TURTLE A 450P5U-2T1,1	450.2.5	400-50	1,1	2,3	2880	68	55	-20/+50	76
TURTLE A 450P6U-2T1,5	450.2.6	400-50	1,5	3,3	2880	62,3	55	-20/+50	79
TURTLE A 450P7U-2T2,2	450.2.7	400-50	2,2	4,5	2880	65,4	55	-20/+50	81
TURTLE A 450P8U-2T1,5	450.2.8	400-50	1,5	3,3	2880	67,3	55	-20/+50	80
TURTLE A 450P9U-2T2,2	450.2.9	400-50	2,2	4,5	2880	65,6	55	-20/+50	82
TURTLE A 450P10U-2T2,2	450.2.10	400-50	2,2	4,5	2880	64,9	55	-20/+50	82
TURTLE A 450P11U-2T3	450.2.11	400-50	3	5,9	2880	66	55	-20/+50	89
TURTLE A 450P12U-2T4	450.2.12	400-50	4	7,9	2880	69,2	55	-20/+50	90
TURTLE A 450P13U-2T3	450.2.13	400-50	3	5,9	2880	64,4	55	-20/+50	89
TURTLE A 450P14U-2T3	450.2.14	400-50	3	5,9	2880	64,4	55	-20/+50	89
TURTLE A 450P15U-2T5,5	450.2.15	400-50	5,5	10,3	2880	65,7	55	-20/+50	105
TURTLE A 500P1U-2T0,75	500.2.1	400-50	0,75	1,7	2880	71,3	55	-20/+50	83
TURTLE A 500P2U-2T1,1	500.2.2	400-50	1,1	2,3	2880	65,8	55	-20/+50	84
TURTLE A 500P3U-2T1,5	500.2.3	400-50	1,5	3,3	2880	67,2	55	-20/+50	87
TURTLE A 500P4U-2T2,2	500.2.4	400-50	2,2	4,5	2880	65,4	55	-20/+50	89
TURTLE A 500P5U-2T2,2	500.2.6	400-50	2,2	4,5	2880	64,9	55	-20/+50	89
TURTLE A 500P6U-2T2,2	500.2.5	400-50	2,2	4,5	2880	61,8	55	-20/+50	89
TURTLE A 500P7U-2T3	500.2.7	400-50	3	5,9	2880	65,4	55	-20/+50	96
TURTLE A 500P8U-2T3	500.2.8	400-50	3	5,9	2880	69	55	-20/+50	96
TURTLE A 500P9U-2T4	500.2.9	400-50	4	7,9	2880	69,5	55	-20/+50	97
TURTLE A 500P10U-2T4	500.2.10	400-50	4	7,9	2880	67,2	55	-20/+50	97
TURTLE A 500P11U-2T5,5	500.2.11	400-50	5,5	10,3	2880	66,9	55	-20/+50	112
TURTLE A 500P12U-2T7,5	500.2.12	400-50	7,5	13,6	2880	67,7	55	-20/+50	120
TURTLE A 500P13U-2T7,5	500.2.13	400-50	7,5	13,6	2880	67,7	55	-20/+50	119
TURTLE A 560P1U-2T0,75	560.2.1	400-50	0,75	1,7	2880	67,7	55	-20/+50	82
TURTLE A 560P2U-2T1,1	560.2.2	400-50	1,1	2,3	2880	65,4	55	-20/+50	82
TURTLE A 560P3U-2T1,5	560.2.3	400-50	1,5	3,3	2880	68,7	55	-20/+50	85
TURTLE A 560P4U-2T2,2	560.2.4	400-50	3	5,9	2880	69	55	-20/+50	89

MODEL	MODEL NUMBER	Voltage Frequency	Motor Power	Current	Rotation Speed	Sound Pressure	Protection Class	Working Range	Mass
		V-Hz	kW	A	RPM	Lp(A) dB at 3m	IP	°C	~ Kg
TURTLE A 560P5U-2T4	560.2.5	400-50	4	7,9	2880	67,7	55	-20/+50	97
TURTLE A 560P6U-2T4	560.2.6	400-50	4	7,9	2880	68,8	55	-20/+50	96
TURTLE A 560P7U-2T5,5	560.2.7	400-50	5,5	10,3	2880	70,6	55	-20/+50	112
TURTLE A 560P8U-2T3	560.2.8	400-50	3	5,9	2880	67,7	55	-20/+50	96
TURTLE A 560P9U-2T4	560.2.9	400-50	4	7,9	2880	68,2	55	-20/+50	96
TURTLE A 560P10U-2T5,5	560.2.10	400-50	5,5	10,3	2880	68,5	55	-20/+50	111
TURTLE A 560P11U-2T7,5	560.2.11	400-50	7,5	13,6	2880	70,3	55	-20/+50	118
TURTLE A 560P12U-2T4	560.2.12	400-50	4	7,9	2880	69,3	55	-20/+50	97
TURTLE A 560P13U-2T5,5	560.2.13	400-50	5,5	10,3	2880	70,7	55	-20/+50	112
TURTLE A 560P14U-2T7,5	560.2.14	400-50	7,5	13,6	2880	69,4	55	-20/+50	119
TURTLE A 560P15U-2T11	560.2.15	400-50	11	19,5	2880	70,1	55	-20/+50	142
TURTLE A 560P16U-2T11	560.2.16	400-50	11	19,5	2880	69,8	55	-20/+50	142
TURTLE A 630P1U-2T2,2	630.2.1	400-50	2,2	4,5	2880	68,7	55	-20/+50	101
TURTLE A 630P2U-2T3	630.2.2	400-50	3	5,9	2880	69,8	55	-20/+50	108
TURTLE A 630P3U-2T5,5	630.2.3	400-50	5,5	10,3	2880	68,2	55	-20/+50	124
TURTLE A 630P4U-2T5,5	630.2.4	400-50	5,5	10,3	2880	70,3	55	-20/+50	124
TURTLE A 630P5U-2T7,5	630.2.5	400-50	7,5	13,6	2880	73,5	55	-20/+50	131
TURTLE A 630P6U-2T7,5	630.2.6	400-50	7,5	13,6	2880	71,4	55	-20/+50	131
TURTLE A 630P7U-2T11	630.2.7	400-50	11	19,5	2880	73,7	55	-20/+50	155
TURTLE A 630P8U-2T11	630.2.8	400-50	11	19,5	2880	71,7	55	-20/+50	154
TURTLE A 630P9U-2T7,5	630.2.9	400-50	7,5	13,6	2880	73,4	55	-20/+50	131
TURTLE A 630P10U-2T11	630.2.10	400-50	11	19,5	2880	71,6	55	-20/+50	154
TURTLE A 630P11U-2T11	630.2.11	400-50	11	19,5	2880	71,7	55	-20/+50	154
TURTLE A 630P12U-2T15	630.2.12	400-50	15	28,3	2880	71,6	55	-20/+50	168
TURTLE A 630P13U-2T15	630.2.13	400-50	15	28,3	2880	73,7	55	-20/+50	168
TURTLE A 630P14U-2T15	630.2.14	400-50	15	28,3	2880	71,5	55	-20/+50	168
TURTLE A 710P1U-2T3	710.2.1	400-50	3	5,9	2880	74,8	55	-20/+50	107
TURTLE A 710P2U-2T5,5	710.2.2	400-50	5,5	10,3	2880	72	55	-20/+50	123
TURTLE A 710P3U-2T7,5	710.2.3	400-50	7,5	13,6	2880	72,3	55	-20/+50	131
TURTLE A 710P4U-2T7,5	710.2.4	400-50	7,5	13,6	2880	73,1	55	-20/+50	131
TURTLE A 710P5U-2T11	710.2.5	400-50	11	19,5	2880	73,9	55	-20/+50	153
TURTLE A 710P6U-2T11	710.2.6	400-50	11	19,5	2880	74,9	55	-20/+50	153
TURTLE A 710P7U-2T5,5	710.2.7	400-50	5,5	10,3	2880	82,5	55	-20/+50	124
TURTLE A 710P8.AU-2T7,5	710.2.8A	400-50	7,5	13,6	2880	78,5	55	-20/+50	131
TURTLE A 710P8.BU-2T11	710.2.8B	400-50	11	19,5	2880	78,5	55	-20/+50	154
TURTLE A 710P9U-2T15	710.2.9	400-50	15	28,3	2880	71,4	55	-20/+50	169
TURTLE A 710P10U-2T11	710.2.10	400-50	11	19,5	2880	76,5	55	-20/+50	154
TURTLE A 710P11U-2T15	710.2.11	400-50	15	28,3	2880	73,3	55	-20/+50	170
TURTLE A 710P12U-2T15	710.2.12	400-50	15	28,3	2880	76,5	55	-20/+50	168
TURTLE A 710P13U-2T18,5	710.2.13	400-50	18,5	32,3	2880	77,5	55	-20/+50	189
TURTLE A 710P14U-2T18,5	710.2.14	400-50	18,5	32,3	2880	77,5	55	-20/+50	189
TURTLE A 800P1U-2T11	800.2.1	400-50	11	19,5	2880	77,5	55	-20/+50	173
TURTLE A 800P2U-2T15	800.2.2	400-50	15	28,3	2880	78,5	55	-20/+50	187
TURTLE A 800P3U-2T18,5	800.2.3	400-50	18,5	32,3	2880	80,5	55	-20/+50	210
TURTLE A 800P4U-2T22	800.2.4	400-50	22	38,3	2880	81,5	55	-20/+50	242
TURTLE A 800P5U-2T18,5	800.2.5	400-50	18,5	32,3	2880	81,5	55	-20/+50	205
TURTLE A 800P6U-2T18,5	800.2.6	400-50	18,5	32,3	2880	81,5	55	-20/+50	205
TURTLE A 800P7U-2T22	800.2.7	400-50	22	38,3	2880	81,5	55	-20/+50	237

MODEL	MODEL NUMBER	Voltage Frequency	Motor Power	Current	Rotation Speed	Sound Pressure	Protection Class	Working Range	Mass
		V-Hz	kW	A	RPM	Lp(A) dB at 3m	IP	°C	~ Kg
TURTLE A 400P1U-4T0,75	400.4.1	400-50	0,37	1,13	1440	46,5	55	-20/+50	58
TURTLE A 400P2U-4T0,75	400.4.2	400-50	0,37	1,13	1440	46,7	55	-20/+50	58
TURTLE A 400P3U-4T0,75	400.4.3	400-50	0,37	1,13	1440	47,6	55	-20/+50	58
TURTLE A 450P1U-4T0,75	450.4.1	400-50	0,37	1,13	1440	48,7	55	-20/+50	61
TURTLE A 450P2U-4T0,75	450.4.2	400-50	0,37	1,13	1440	50,6	55	-20/+50	61
TURTLE A 450P3U-4T0,75	450.4.3	400-50	0,37	1,13	1440	50,7	55	-20/+50	61
TURTLE A 450P4U-4T0,75	450.4.4	400-50	0,55	1,55	1440	49,4	55	-20/+50	61
TURTLE A 450P5U-4T0,75	450.4.5	400-50	0,37	1,13	1440	49,4	55	-20/+50	61
TURTLE A 450P6U-4T0,75	450.4.6	400-50	0,55	1,55	1440	49,4	55	-20/+50	61
TURTLE A 450P7U-4T0,75	450.4.7	400-50	0,75	2	1440	49,5	55	-20/+50	61
TURTLE A 500P1U-4T0,75	500.4.1	400-50	0,37	1,13	1440	47,7	55	-20/+50	64
TURTLE A 500P2U-4T0,75	500.4.2	400-50	0,55	1,55	1440	52,5	55	-20/+50	64
TURTLE A 500P3U-4T0,75	500.4.3	400-50	0,37	1,13	1440	53,6	55	-20/+50	64
TURTLE A 500P4U-4T0,75	500.4.4	400-50	0,75	2	1440	52,8	55	-20/+50	64
TURTLE A 500P5U-4T0,75	500.4.5	400-50	0,55	1,55	1440	53,8	55	-20/+50	64
TURTLE A 500P6U-4T0,75	500.4.6	400-50	0,75	2	1440	53,8	55	-20/+50	64
TURTLE A 500P7U-4T1,1	500.4.7	400-50	1,1	2,6	1440	54,5	55	-20/+50	74
TURTLE A 560P1U-4T0,75	560.4.1	400-50	0,37	1,13	1440	54,6	55	-20/+50	75
TURTLE A 560P2U-4T0,75	560.4.2	400-50	0,55	1,55	1440	54,2	55	-20/+50	75
TURTLE A 560P3U-4T0,75	560.4.3	400-50	0,75	2	1440	55,5	55	-20/+50	75
TURTLE A 560P4U-4T0,75	560.4.4	400-50	0,75	2	1440	56	55	-20/+50	75
TURTLE A 560P5U-4T1,1	560.4.5	400-50	1,1	2,6	1440	55,7	55	-20/+50	74
TURTLE A 560P6U-4T0,75	560.4.6	400-50	0,37	1,13	1440	56,3	55	-20/+50	75
TURTLE A 560P7U-4T0,75	560.4.7	400-50	0,75	2	1440	55,8	55	-20/+50	75
TURTLE A 560P8U-4T1,1	560.4.8	400-50	1,1	2,6	1440	54,8	55	-20/+50	74
TURTLE A 560P9U-4T1,1	560.4.9	400-50	1,1	2,6	1440	55,3	55	-20/+50	74
TURTLE A 560P10U-4T1,5	560.4.10	400-50	1,5	3,5	1440	56,2	55	-20/+50	74
TURTLE A 630P1U-4T0,75	630.4.1	400-50	0,55	1,55	1440	56,4	55	-20/+50	74
TURTLE A 630P2U-4T0,75	630.4.2	400-50	0,55	1,55	1440	56	55	-20/+50	74
TURTLE A 630P3U-4T0,75	630.4.3	400-50	0,75	2	1440	54,2	55	-20/+50	74
TURTLE A 630P4U-4T1,1	630.4.4	400-50	1,1	2,6	1440	57,6	55	-20/+50	74
TURTLE A 630P5U-4T1,5	630.4.5	400-50	1,5	3,5	1440	58,4	55	-20/+50	74
TURTLE A 630P6U-4T1,5	630.4.6	400-50	0,75	2	1440	57,2	55	-20/+50	74
TURTLE A 630P7U-4T2,2	630.4.7	400-50	2,2	5	1440	61,1	55	-20/+50	74
TURTLE A 630P8U-4T0,75	630.4.8	400-50	0,75	2	1440	57,8	55	-20/+50	74
TURTLE A 630P9U-4T0,75	630.4.9	400-50	0,75	2	1440	63	55	-20/+50	74
TURTLE A 630P10U-4T1,1	630.4.10	400-50	1,1	2,6	1440	56,5	55	-20/+50	74
TURTLE A 630P11U-4T1,5	630.4.11	400-50	1,5	3,5	1440	56,4	55	-20/+50	74
TURTLE A 630P12U-4T1,5	630.4.12	400-50	1,5	3,5	1440	57	55	-20/+50	74
TURTLE A 630P13U-4T2,2	630.4.13	400-50	2,2	5	1440	58	55	-20/+50	74
TURTLE A 630P14U-4T2,2	630.4.14	400-50	2,2	5	1440	58,1	55	-20/+50	74
TURTLE A 630P15U-4T1,5	630.4.15	400-50	1,5	3,5	1440	61,3	55	-20/+50	74
TURTLE A 630P16U-4T2,2	630.4.16	400-50	2,2	5	1440	61,2	55	-20/+50	74
TURTLE A 630P17U-4T2,2	630.4.17	400-50	2,2	5	1440	61,1	55	-20/+50	74
TURTLE A 630P18U-4T2,2	630.4.18	400-50	2,2	5	1440	61,4	55	-20/+50	74
TURTLE A 630P19U-4T3	630.4.19	400-50	3	6,6	1440	62,8	55	-20/+50	74

MODEL	MODEL NUMBER	Voltage Frequency	Motor Power	Current	Rotation Speed	Sound Pressure	Protection Class	Working Range	Mass
		V-Hz	kW	A	RPM	Lp(A) dB at 3m	IP	°C	~ Kg
TURTLE A 710P1U-4T0,75	710.4.1	400-50	0,75	2	1440	61,8	55	-20/+50	87
TURTLE A 710P2U-4T1,5	710.4.2	400-50	1,5	3,5	1440	59	55	-20/+50	87
TURTLE A 710P3U-4T1,5	710.4.3	400-50	1,5	3,5	1440	61,9	55	-20/+50	87
TURTLE A 710P4U-4T2,2	710.4.4	400-50	2,2	5	1440	62	55	-20/+50	87
TURTLE A 710P5U-4T3	710.4.5	400-50	3	6,6	1440	62,8	55	-20/+50	87
TURTLE A 710P6U-4T3	710.4.6	400-50	3	6,6	1440	63,5	55	-20/+50	87
TURTLE A 710P7U-4T3	710.4.7	400-50	3	6,6	1440	64,1	55	-20/+50	87
TURTLE A 710P8U-4T1,5	710.4.8	400-50	1,5	3,5	1440	59,8	55	-20/+50	87
TURTLE A 710P9U-4T2,2	710.4.9	400-50	2,2	5	1440	58,2	55	-20/+50	87
TURTLE A 710P10U-4T2,2	710.4.10	400-50	2,2	5	1440	63,8	55	-20/+50	87
TURTLE A 710P11U-4T3	710.4.11	400-50	3	6,6	1440	63	55	-20/+50	87
TURTLE A 710P12U-4T4	710.4.12	400-50	4	8,4	1440	63,5	55	-20/+50	86
TURTLE A 710P13U-4T4	710.4.13	400-50	4	8,4	1440	62,5	55	-20/+50	86
TURTLE A 710P14U-4T5,5	710.4.14	400-50	5,5	11,2	1440	63,5	55	-20/+50	86
TURTLE A 800P1U-4T2,2	800.4.1	400-50	2,2	5	1440	66,8	55	-20/+50	99
TURTLE A 800P2U-4T3	800.4.2	400-50	3	6,6	1440	65	55	-20/+50	99
TURTLE A 800P3U-4T3	800.4.3	400-50	3	6,6	1440	64,1	55	-20/+50	99
TURTLE A 800P4U-4T4	800.4.4	400-50	4	8,4	1440	65,1	55	-20/+50	99
TURTLE A 800P5U-4T4	800.4.5	400-50	4	8,4	1440	65,3	55	-20/+50	99
TURTLE A 800P6U-4T4	800.4.6	400-50	4	8,4	1440	64,6	55	-20/+50	99
TURTLE A 800P7U-4T5,5	800.4.7	400-50	5,5	11,2	1440	66,1	55	-20/+50	98
TURTLE A 800P8U-4T5,5	800.4.8	400-50	5,5	11,2	1440	66,8	55	-20/+50	98
TURTLE A 800P9U-4T1,5	800.4.9	400-50	1,5	3,5	1440	69,2	55	-20/+50	99
TURTLE A 800P10U-4T3	800.4.10	400-50	3	6,6	1440	68,1	55	-20/+50	99
TURTLE A 800P11U-4T4	800.4.11	400-50	4	8,4	1440	66,7	55	-20/+50	99
TURTLE A 800P12U-4T5,5	800.4.12	400-50	5,5	11,2	1440	65,7	55	-20/+50	98
TURTLE A 800P13U-4T7,5	800.4.13	400-50	7,5	15,4	1440	66,7	55	-20/+50	98
TURTLE A 800P14U-4T2,2	800.4.14	400-50	2,2	5	1440	68,3	55	-20/+50	99
TURTLE A 800P15U-4T11	800.4.15	400-50	11	21,3	1440	67,1	55	-20/+50	98
TURTLE A 800P16U-4T7,5	800.4.16	400-50	7,5	15,4	1440	66,9	55	-20/+50	98
TURTLE A 800P17U-4T11	800.4.17	400-50	11	21,3	1440	67,4	55	-20/+50	98
TURTLE A 800P18U-4T4	800.4.18	400-50	4	8,4	1440	67,8	55	-20/+50	99
TURTLE A 800P19U-4T4	800.4.19	400-50	4	8,4	1440	68	55	-20/+50	99
TURTLE A 800P20U-4T5,5	800.4.20	400-50	5,5	11,2	1440	67,5	55	-20/+50	98
TURTLE A 800P21U-4T5,5	800.4.21	400-50	5,5	11,2	1440	66,9	55	-20/+50	98
TURTLE A 900P1U-4T5,5	900.4.1	400-50	5,5	11,2	1440	72,7	55	-20/+50	100
TURTLE A 900P2U-4T7,5	900.4.2	400-50	7,5	15,4	1440	66,5	55	-20/+50	100
TURTLE A 900P3U-4T4	900.4.3	400-50	4	8,4	1440	66,3	55	-20/+50	101
TURTLE A 900P4U-4T5,5	900.4.4	400-50	5,5	11,2	1440	66,4	55	-20/+50	100
TURTLE A 900P5U-4T4	900.4.5	400-50	4	8,4	1440	69,9	55	-20/+50	101
TURTLE A 900P6U-4T5,5	900.4.6	400-50	5,5	11,2	1440	69,1	55	-20/+50	100
TURTLE A 900P7U-4T7,5	900.4.7	400-50	7,5	15,4	1440	69,2	55	-20/+50	100
TURTLE A 900P8U-4T7,5	900.4.8	400-50	7,5	15,4	1440	67,7	55	-20/+50	100
TURTLE A 900P9U-4T7,5	900.4.9	400-50	7,5	15,4	1440	68,5	55	-20/+50	100
TURTLE A 900P10U-4T7,5	900.4.10	400-50	7,5	15,4	1440	69,2	55	-20/+50	100
TURTLE A 900P11U-4T11	900.4.11	400-50	11	21,3	1440	68,8	55	-20/+50	100

MODEL	MODEL NUMBER	Voltage Frequency	Motor Power	Current	Rotation Speed	Sound Pressure	Protection Class	Working Range	Mass
		V-Hz	kW	A	RPM	Lp(A) dB at 3m	IP	°C	~ Kg
TURTLE A 900P12U-4T11	900.4.12	400-50	11	21,3	1440	68,9	55	-20/+50	100
TURTLE A 900P13U-4T15	900.4.13	400-50	15	29,8	1440	68	55	-20/+50	100
TURTLE A 900P14U-4T7,5	900.4.14	400-50	7,5	15,4	1440	69,1	55	-20/+50	100
TURTLE A 900P15U-4T7,5	900.4.15	400-50	7,5	15,4	1440	71,9	55	-20/+50	100
TURTLE A 900P16U-4T11	900.4.16	400-50	11	21,3	1440	73,8	55	-20/+50	100
TURTLE A 900P17U-4T15	900.4.17	400-50	15	29,8	1440	69,7	55	-20/+50	100
TURTLE A 900P18U-4T15	900.4.18	400-50	15	29,8	1440	69,5	55	-20/+50	100
TURTLE A 900P19U-4T15	900.4.19	400-50	15	29,8	1440	70,3	55	-20/+50	100
TURTLE A 900P20U-4T11	900.4.20	400-50	11	21,3	1440	69,4	55	-20/+50	100
TURTLE A 900P21U-4T11	900.4.21	400-50	11	21,3	1440	69,4	55	-20/+50	100
TURTLE A 900P22U-4T15	900.4.22	400-50	15	29,8	1440	67,6	55	-20/+50	100
TURTLE A 1000P1U-4T3	1000.4.1	400-50	3	6,6	1440	66,1	55	-20/+50	136
TURTLE A 1000P2U-4T3	1000.4.2	400-50	3	6,6	1440	67	55	-20/+50	136
TURTLE A 1000P3U-4T4	1000.4.3	400-50	4	8,4	1440	67,7	55	-20/+50	136
TURTLE A 1000P4U-4T4	1000.4.4	400-50	4	8,4	1440	68,5	55	-20/+50	136
TURTLE A 1000P5U-4T5,5	1000.4.5	400-50	5,5	11,2	1440	68,4	55	-20/+50	136
TURTLE A 1000P6U-4T7,5	1000.4.6	400-50	7,5	15,4	1440	71,7	55	-20/+50	136
TURTLE A 1000P7U-4T11	1000.4.7	400-50	11	21,3	1440	73,4	55	-20/+50	136
TURTLE A 1000P8U-4T5,5	1000.4.8	400-50	5,5	11,2	1440	67,8	55	-20/+50	136
TURTLE A 1000P9U-4T7,5	1000.4.9	400-50	7,5	15,4	1440	69,3	55	-20/+50	136
TURTLE A 1000P10U-4T5,5	1000.4.10	400-50	5,5	11,2	1440	70,9	55	-20/+50	136
TURTLE A 1000P11U-4T7,5	1000.4.11	400-50	7,5	15,4	1440	74	55	-20/+50	136
TURTLE A 1000P12U-4T11	1000.4.12	400-50	11	21,3	1440	72	55	-20/+50	136
TURTLE A 1000P13U-4T11	1000.4.13	400-50	11	21,3	1440	72,4	55	-20/+50	136
TURTLE A 1000P14U-4T15	1000.4.14	400-50	15	29,8	1440	73,8	55	-20/+50	136
TURTLE A 1000P15U-4T15	1000.4.15	400-50	15	29,8	1440	74,4	55	-20/+50	136
TURTLE A 1000P16U-4T7,5	1000.4.16	400-50	7,5	15,4	1440	71,7	55	-20/+50	136
TURTLE A 1000P17U-4T7,5	1000.4.17	400-50	7,5	15,4	1440	71,3	55	-20/+50	136
TURTLE A 1000P18U-4T11	1000.4.18	400-50	11	21,3	1440	71,3	55	-20/+50	136
TURTLE A 1000P19U-4T11	1000.4.19	400-50	11	21,3	1440	72	55	-20/+50	136
TURTLE A 1000P20U-4T11	1000.4.20	400-50	11	21,3	1440	76,5	55	-20/+50	136
TURTLE A 1000P21U-4T11	1000.4.21	400-50	11	21,3	1440	76,5	55	-20/+50	136
TURTLE A 1000P22U-4T15	1000.4.22	400-50	15	29,8	1440	75,5	55	-20/+50	136
TURTLE A 1000P23U-4T15	1000.4.23	400-50	15	29,8	1440	74,4	55	-20/+50	136
TURTLE A 1000P24U-4T22	1000.4.24	400-50	22	42,5	1440	75,5	55	-20/+50	135
TURTLE A 1000P25.AU-4T11	1000.4.25.A	400-50	11	21,3	1440	69,3	55	-20/+50	136
TURTLE A 1000P25.BU-4T15	1000.4.25.B	400-50	15	29,8	1440	69,3	55	-20/+50	136
TURTLE A 1000P26U-4T15	1000.4.26	400-50	15	29,8	1440	71	55	-20/+50	136
TURTLE A 1000P27U-4T22	1000.4.27	400-50	22	42,5	1440	72,4	55	-20/+50	135
TURTLE A 1000P28U-4T30	1000.4.28	400-50	30	55	1440	75,1	55	-20/+50	134
TURTLE A 1000P29U-4T22	1000.4.29	400-50	22	42,5	1440	73,5	55	-20/+50	135
TURTLE A 1000P30U-4T30	1000.4.30	400-50	30	55	1440	73,8	55	-20/+50	134
TURTLE A 1000P31U-4T7,5	1000.4.31	400-50	7,5	15,4	1440	74,8	55	-20/+50	136
TURTLE A 1000P32U-4T11	1000.4.32	400-50	11	21,3	1440	71,9	55	-20/+50	136
TURTLE A 1000P33U-4T15	1000.4.33	400-50	15	29,8	1440	71,4	55	-20/+50	136
TURTLE A 1000P34U-4T22	1000.4.34	400-50	22	42,5	1440	78,5	55	-20/+50	135

CABINET FAN

MODEL	MODEL NUMBER	Voltage Frequency	Motor Power	Current	Rotation Speed	Sound Pressure	Protection Class	Working Range	Mass
		V-Hz	kW	A	RPM	Lp(A) dB at 3m	IP	°C	~ Kg
TURTLE A 1000P35U-4T22	1000.4.35	400-50	22	42,5	1440	78,5	55	-20/+50	135
TURTLE A 1000P36U-4T30	1000.4.36	400-50	30	55	1440	77,5	55	-20/+50	134
TURTLE A 1000P37U-4T37	1000.4.37	400-50	37	67	1440	76,5	55	-20/+50	134
TURTLE A 1120P1U-4T5,5	1120.4.1	400-50	5,5	11,2	1440	71,5	55	-20/+50	132
TURTLE A 1120P2U-4T7,5	1120.4.2	400-50	7,5	15,4	1440	72,1	55	-20/+50	132
TURTLE A 1120P3U-4T11	1120.4.3	400-50	11	21,3	1440	73,6	55	-20/+50	151
TURTLE A 1120P4U-4T11	1120.4.4	400-50	11	21,3	1440	73,8	55	-20/+50	151
TURTLE A 1120P5U-4T15	1120.4.5	400-50	15	29,8	1440	75,1	55	-20/+50	151
TURTLE A 1120P6U-4T18,5	1120.4.6	400-50	18,5	34,5	1440	76,5	55	-20/+50	151
TURTLE A 1120P7U-4T7,5	1120.4.7	400-50	7,5	15,4	1440	73,1	55	-20/+50	132
TURTLE A 1120P8U-4T11	1120.4.8	400-50	11	21,3	1440	76,5	55	-20/+50	151
TURTLE A 1120P9U-4T11	1120.4.9	400-50	11	21,3	1440	75,5	55	-20/+50	151
TURTLE A 1120P10U-4T15	1120.4.10	400-50	15	29,8	1440	74,3	55	-20/+50	151
TURTLE A 1120P11U-4T15	1120.4.11	400-50	15	29,8	1440	73,8	55	-20/+50	151
TURTLE A 1120P12U-4T18,5	1120.4.12	400-50	18,5	34,5	1440	75,5	55	-20/+50	151
TURTLE A 1120P13U-4T22	1120.4.13	400-50	22	42,5	1440	76,5	55	-20/+50	151
TURTLE A 1120P14U-4T22	1120.4.14	400-50	22	42,5	1440	77,5	55	-20/+50	151
TURTLE A 1120P15U-4T22	1120.4.15	400-50	22	42,5	1440	76,5	55	-20/+50	151
TURTLE A 1120P16U-4T11	1120.4.16	400-50	11	21,3	1440	78,5	55	-20/+50	151
TURTLE A 1120P17U-4T15	1120.4.17	400-50	15	29,8	1440	78,5	55	-20/+50	151
TURTLE A 1120P18U-4T15	1120.4.18	400-50	15	29,8	1440	78,5	55	-20/+50	151
TURTLE A 1120P19U-4T22	1120.4.19	400-50	22	42,5	1440	76,5	55	-20/+50	151
TURTLE A 1120P20U-4T30	1120.4.20	400-50	30	55	1440	79,5	55	-20/+50	166
TURTLE A 1120P21U-4T5,5	1120.4.21	400-50	5,5	11,2	1440	79,5	55	-20/+50	132
TURTLE A 1120P22U-4T7,5	1120.4.22	400-50	7,5	15,4	1440	79,5	55	-20/+50	132
TURTLE A 1120P23U-4T11	1120.4.23	400-50	11	21,3	1440	75,1	55	-20/+50	151
TURTLE A 1120P24U-4T15	1120.4.24	400-50	15	29,8	1440	74,6	55	-20/+50	151
TURTLE A 1120P25U-4T18,5	1120.4.25	400-50	18,5	34,5	1440	73,6	55	-20/+50	151
TURTLE A 1120P26U-4T11	1120.4.26	400-50	11	21,3	1440	79,5	55	-20/+50	151
TURTLE A 1120P27U-4T15	1120.4.27	400-50	15	29,8	1440	79,5	55	-20/+50	151
TURTLE A 1120P28U-4T15	1120.4.28	400-50	15	29,8	1440	78,5	55	-20/+50	151
TURTLE A 1120P29U-4T18,5	1120.4.29	400-50	18,5	34,5	1440	77,5	55	-20/+50	151
TURTLE A 1120P30U-4T18,5	1120.4.30	400-50	18,5	34,5	1440	77,5	55	-20/+50	151
TURTLE A 1120P31U-4T22	1120.4.31	400-50	22	42,5	1440	77,5	55	-20/+50	151
TURTLE A 1120P32U-4T30	1120.4.32	400-50	30	55	1440	76,5	55	-20/+50	166
TURTLE A 1120P33U-4T37	1120.4.33	400-50	37	67	1440	76,5	55	-20/+50	166
TURTLE A 1120P34U-4T22	1120.4.34	400-50	22	42,5	1440	78,5	55	-20/+50	166
TURTLE A 1120P35U-4T30	1120.4.35	400-50	30	55	1440	77,5	55	-20/+50	166
TURTLE A 1120P36U-4T15	1120.4.36	400-50	15	29,8	1440	80,5	55	-20/+50	151
TURTLE A 1120P37U-4T22	1120.4.37	400-50	22	42,5	1440	77,5	55	-20/+50	151
TURTLE A 1120P38U-4T45	1120.4.38	400-50	45	80	1440	77,5	55	-20/+50	166
TURTLE A 1120P39U-4T22	1120.4.39	400-50	22	42,5	1440	73,1	55	-20/+50	151
TURTLE A 1120P40U-4T30	1120.4.40	400-50	30	55	1440	74,1	55	-20/+50	166
TURTLE A 1250P1U-4T11	1250.4.1	400-50	11	21,3	1440	79,5	55	-20/+50	148
TURTLE A 1250P2U-4T15	1250.4.2	400-50	15	29,8	1440	78,5	55	-20/+50	148
TURTLE A 1250P3U-4T18,5	1250.4.3	400-50	18,5	34,5	1440	78,5	55	-20/+50	147

MODEL	MODEL NUMBER	Voltage Frequency	Motor Power	Current	Rotation Speed	Sound Pressure	Protection Class	Working Range	Mass
		V-Hz	kW	A	RPM	Lp(A) dB at 3m	IP	°C	~ Kg
TURTLE A 1250P4U-4T18,5	1250.4.4	400-50	18,5	34,5	1440	78,5	55	-20/+50	147
TURTLE A 1250P5U-4T22	1250.4.5	400-50	22	42,5	1440	78,5	55	-20/+50	147
TURTLE A 1250P6U-4T11	1250.4.6	400-50	11	21,3	1440	83,5	55	-20/+50	148
TURTLE A 1250P7U-4T18,5	1250.4.7	400-50	18,5	34,5	1440	84,5	55	-20/+50	147
TURTLE A 1250P8U-4T22	1250.4.8	400-50	22	42,5	1440	84,5	55	-20/+50	147
TURTLE A 1250P9U-4T22	1250.4.9	400-50	22	42,5	1440	84,5	55	-20/+50	147
TURTLE A 1250P10U-4T22	1250.4.10	400-50	22	42,5	1440	84,5	55	-20/+50	147
TURTLE A 1250P11U-4T30	1250.4.11	400-50	30	55	1440	82,5	55	-20/+50	147
TURTLE A 1250P12U-4T30	1250.4.12	400-50	30	55	1440	83,5	55	-20/+50	147
TURTLE A 1250P13U-4T30	1250.4.13	400-50	30	55	1440	77,5	55	-20/+50	147
TURTLE A 1250P14U-4T30	1250.4.14	400-50	30	55	1440	83,5	55	-20/+50	147
TURTLE A 1250P15U-4T30	1250.4.15	400-50	30	55	1440	78,5	55	-20/+50	147
TURTLE A 1250P16U-4T30	1250.4.16	400-50	30	55	1440	79,5	55	-20/+50	147
TURTLE A 1250P17U-4T37	1250.4.17	400-50	37	67	1440	79,5	55	-20/+50	146
TURTLE A 1250P18U-4T37	1250.4.18	400-50	37	67	1440	79,5	55	-20/+50	146
TURTLE A 1250P19U-4T37	1250.4.19	400-50	37	67	1440	79,5	55	-20/+50	146
TURTLE A 1250P20U-4T45	1250.4.20	400-50	45	80	1440	79,5	55	-20/+50	146
TURTLE A 1250P21U-4T45	1250.4.21	400-50	45	80	1440	79,5	55	-20/+50	146
TURTLE A 1250P22U-4T45	1250.4.22	400-50	45	80	1440	79,5	55	-20/+50	146
TURTLE A 1250P23U-4T45	1250.4.23	400-50	45	80	1440	37,5	55	-20/+50	146
TURTLE A 1250P24U-4T45	1250.4.24	400-50	45	80	1440	80,5	55	-20/+50	146
TURTLE A 1250P25U-4T55	1250.4.25	400-50	55	96,8	1440	81,5	55	-20/+50	145
TURTLE A 1250P26U-4T55	1250.4.26	400-50	55	96,8	1440	81,5	55	-20/+50	145
TURTLE A 1250P27U-4T55	1250.4.27	400-50	55	96,8	1440	81,5	55	-20/+50	145
TURTLE A 1250P28U-4T22	1250.4.28	400-50	22	42,5	1440	84,5	55	-20/+50	147
TURTLE A 1250P29.AU-4T22	1250.4.29.A	400-50	22	42,5	1440	84,5	55	-20/+50	147
TURTLE A 1250P29.BU-4T30	1250.4.29.B	400-50	30	55	1440	84,5	55	-20/+50	147
TURTLE A 1250P30U-4T30	1250.4.30	400-50	30	55	1440	82,5	55	-20/+50	147
TURTLE A 1250P31U-4T30	1250.4.31	400-50	30	55	1440	82,5	55	-20/+50	147
TURTLE A 1250P32U-4T45	1250.4.32	400-50	45	80	1440	80,5	55	-20/+50	146
TURTLE A 1250P33U-4T55	1250.4.33	400-50	55	96,8	1440	79,5	55	-20/+50	145
TURTLE A 1250P34U-4T55	1250.4.34	400-50	55	96,8	1440	79,5	55	-20/+50	145
TURTLE A 1250P35U-4T55	1250.4.35	400-50	55	96,8	1440	79,5	55	-20/+50	145
TURTLE A 1250P36U-4T11	1250.4.36	400-50	11	21,3	1440	72,5	55	-20/+50	148
TURTLE A 1250P37U-4T18,5	1250.4.37	400-50	18,5	34,5	1440	74,8	55	-20/+50	147
TURTLE A 1250P38U-4T22	1250.4.38	400-50	22	42,5	1440	75,4	55	-20/+50	147
TURTLE A 1250P39U-4T30	1250.4.39	400-50	30	55	1440	80,5	55	-20/+50	147
TURTLE A 1250P40U-4T30	1250.4.40	400-50	30	55	1440	81,5	55	-20/+50	147
TURTLE A 1250P41U-4T37	1250.4.41	400-50	37	67	1440	78,5	55	-20/+50	146
TURTLE A 1250P42U-4T37	1250.4.42	400-50	37	67	1440	79,5	55	-20/+50	146

NOVVES

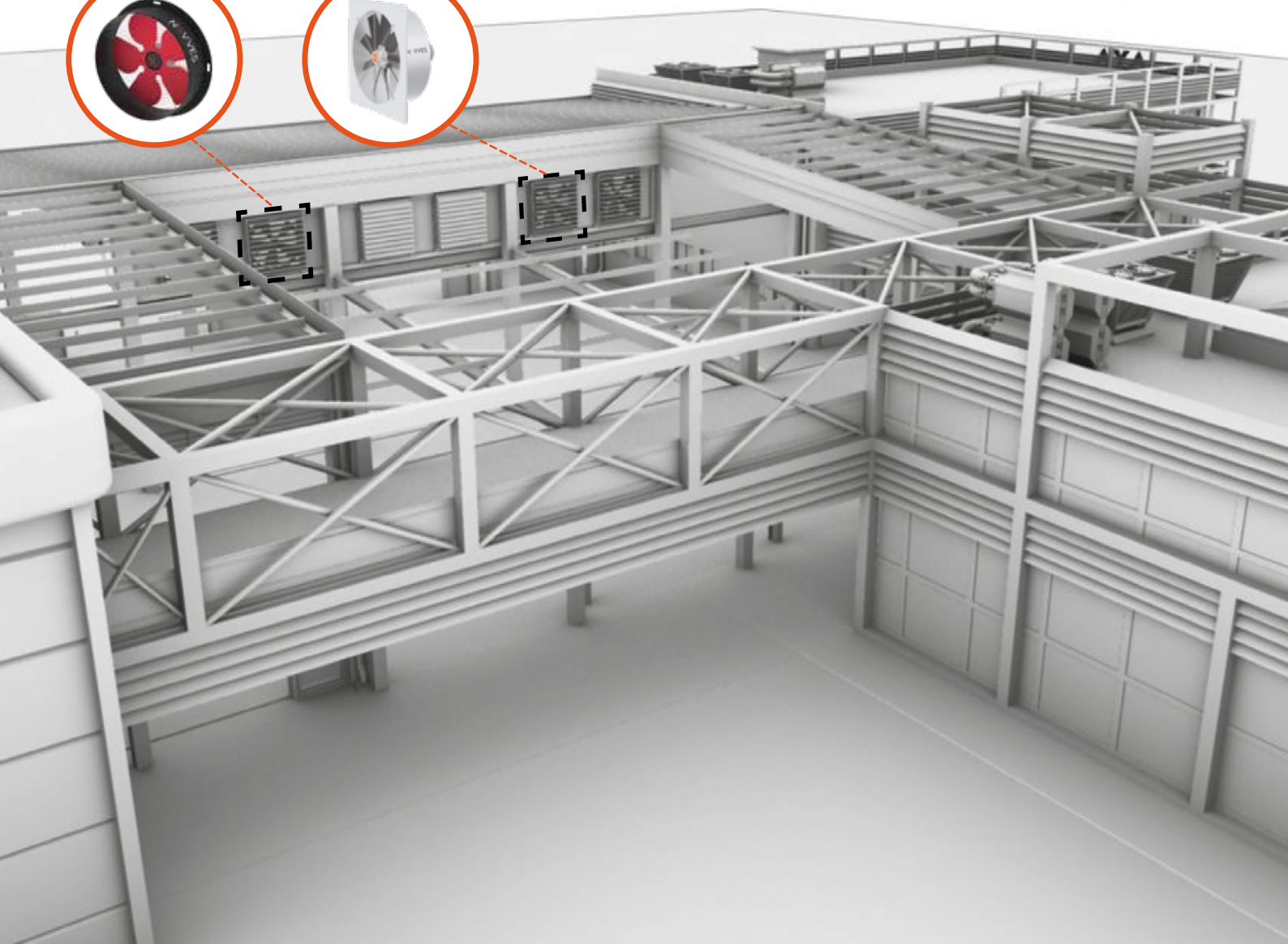

Owl
Wall Fan

OWL SERIES



General

Designed with square and round frames to facilitate direct mounting on the wall, Owl series fans offer advantageous solutions for air evacuation of large-scale areas that require high flow rates such as warehouses, hangars, paint shops and factories. The long-lasting series is produced in a way that does not require maintenance in the long run. It offers maximum air flow and performance at low noise levels thanks to its compact design and ideal blade angles.

Body

The body, which is made of electrostatic powder coated steel, can also be produced from hot-dip galvanized optionally. The motor is connected to the main body with steel carriers. Fans in this series can be easily mounted on the wall.

Impeller

The OWL RER-CER Series consists of aerodynamically optimized metal axial blades. OWL RWA-CWA Series consists of aerodynamically optimized aerofoil axial blades. The blades are glass fiber reinforced composite material. Propellers are dynamically and statically balanced in accordance with ISO 1940

Motor

The OWL RER-CER Series has an external rotor motor with a closed structure and is suitable for operation up to a maximum of 40°C. Three-phase asynchronous motor is available in OWL RWA-CWA Series. It can be used in the exhaust of air up to 50°C.

IP Class

OWL RWA-CWA Series models are in IP 24 protection class, OWL RWA-CWA Series models are in IP 55 protection class.

Control

Single-phase motor fans can be operated directly with the on/off switch, and three-phase motor fans can be operated directly with the help of the MCC panel. The speed adjustment of the models with single-phase motors is made by the speed switch, and the speed of the models with three-phase motors is made by the frequency inverter.

Fan Code

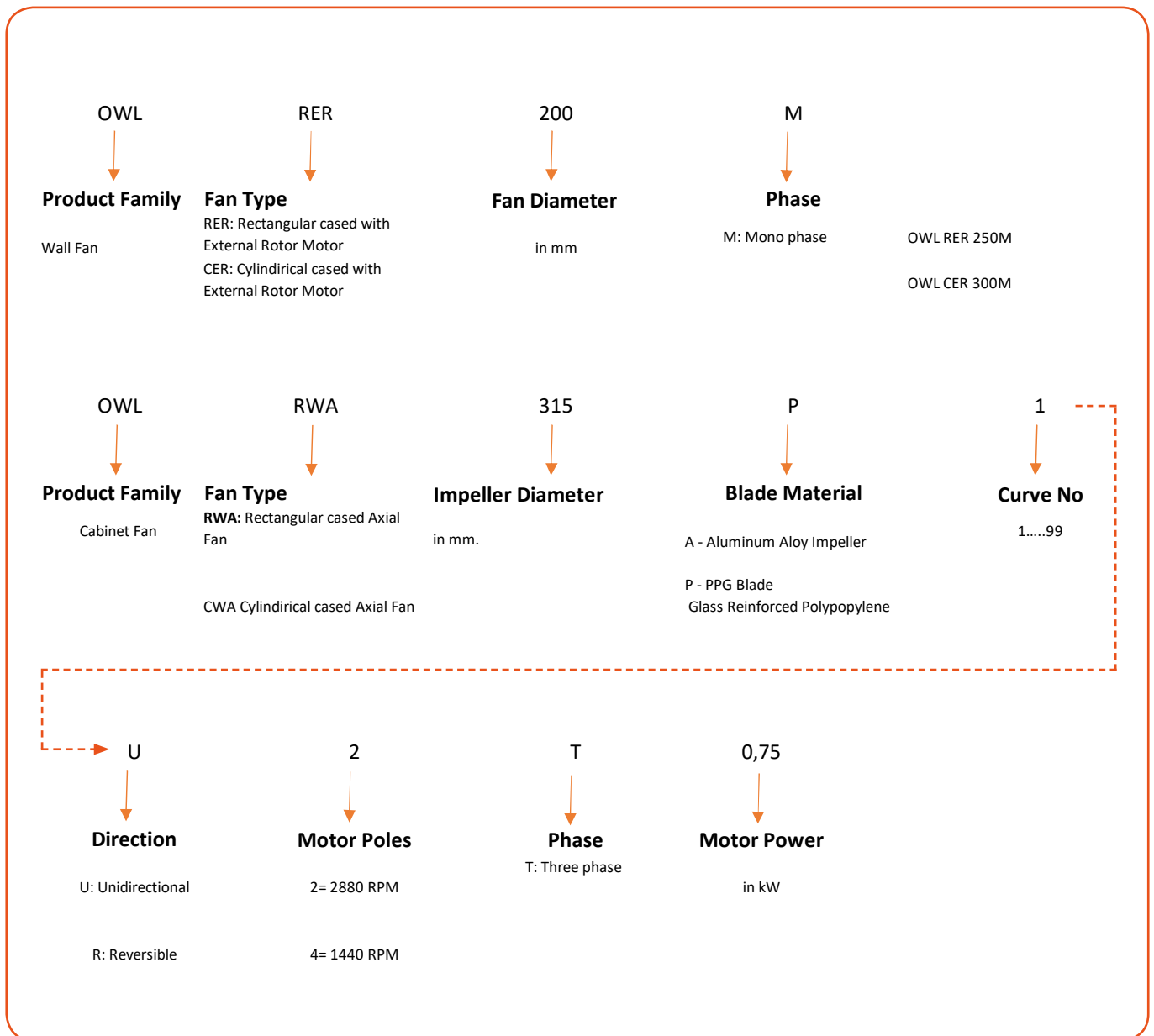

RECTANGULAR WALL TYPES AXIAL FANS WITH METAL BLADES



- Electrostatic oven painted body on galvanized sheet
- Suitable for max. 40°C operation
- Rotational speed can be set with speed controller

OWL RER - SYSTEM CURVE

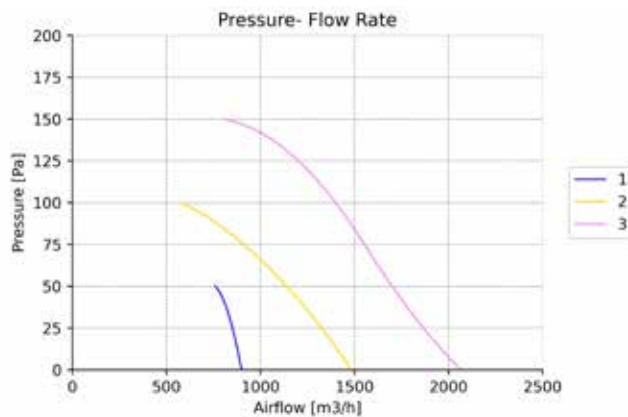

TECHNICAL PARAMETERS

MODEL	MODEL NUMBER	Voltage Frequency	Motor Power	Current	Rotation Speed	Sound Pressure	Protection Class	Working Range	Mass
		V-Hz	W	A	RPM	Lp(A) dB at 3m	IP	°C	Kg
OWL RER 200M	1	230-50	75	0,36	900	60	24	-25/60	1,85
OWL RER 250M	2	230-50	90	0,42	2400	65	24	-25/70	2
OWL RER 300M	3	230-50	104	0,47	1950	68	24	-25/50	3

PRODUCT DIMENSIONS

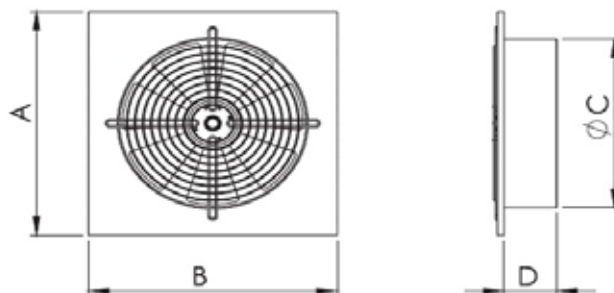

MODEL	A	B	C	D
OWL RER 200M	250	250	197	85
OWL RER 250M	300	300	247	85
OWL RER 300M	350	350	297	85

ROUND WALL TYPES AXIAL FANS WITH METAL BLADES



- Electrostatic oven painted body on galvanized sheet
- Suitable for max. 40°C operation
- Rotational speed can be set with speed controller

OWL CER - SYSTEM CURVE

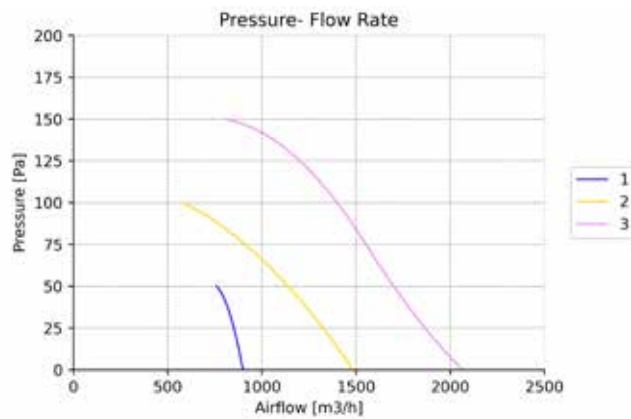

TECHNICAL PARAMETERS

MODEL	MODEL NUMBER	Voltage Frequency	Motor Power	Current	Rotation Speed	Sound Pressure	Protection Class	Working Range	Mass
		V-Hz	W	A	RPM	Lp(A) dB at 3m	IP	°C	Kg
OWL CER 200M	1	230-50	75	0,36	900	60	24	-25/60	1,9
OWL CER 250M	2	230-50	90	0,42	2400	65	24	-25/70	2,1
OWL CER 300M	3	230-50	104	0,47	1950	68	24	-25/50	3,2

PRODUCT DIMENSIONS

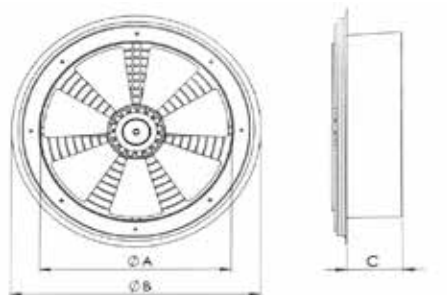

MODEL	A	B	C
OWL CER 200M	197	290	70
OWL CER 250M	247	340	70
OWL CER 300M	297	390	70

RECTANGULAR WALL TYPES AXIAL FANS WITH AEROFIL BLADES



- Electrostatic oven painted body on galvanized sheet
- Blade manufactured from glass fiber composite materials
- Suitable for max. 40°C operation
- Rotational speed can be set with frequency inverter

OWL RWA - SYSTEM CURVE - 2 POLE

Ø315 / 3-4 Blade

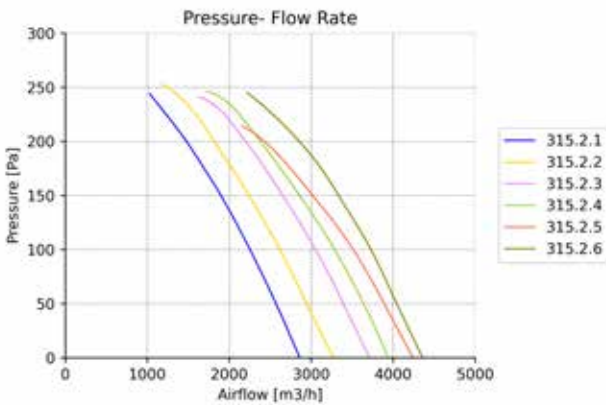

Ø315 / 6 Blade

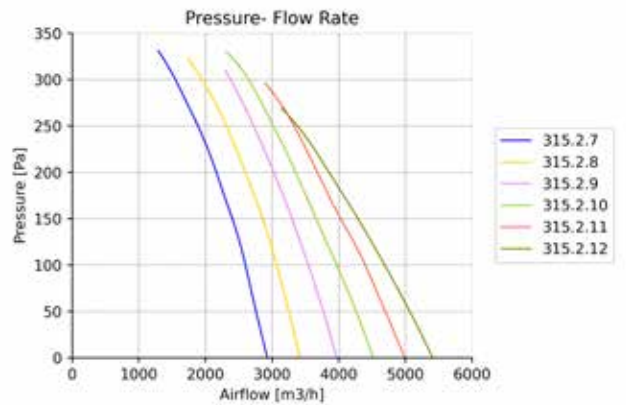

Ø355 / 3 Blade

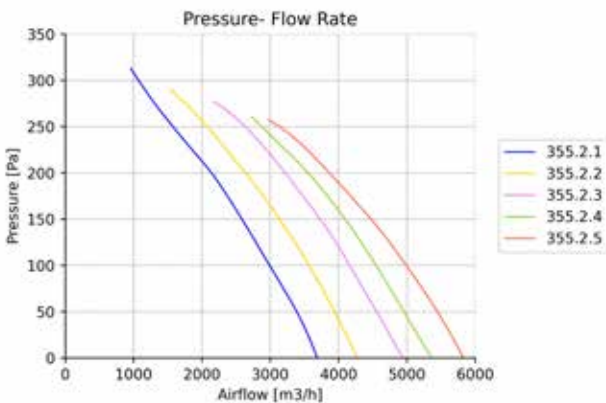

Ø355 / 4-6-8 Blade

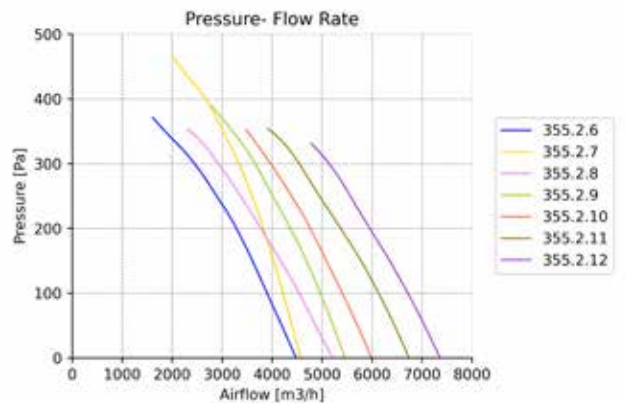

OWL RWA - SYSTEM CURVE - 2 POLE

Ø400 / 3-4-5 Blade

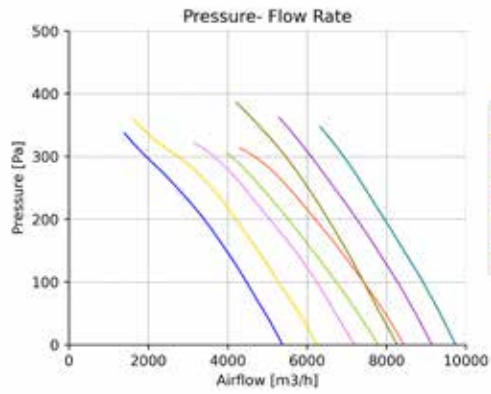

Ø400 / 6-8-10 Blade

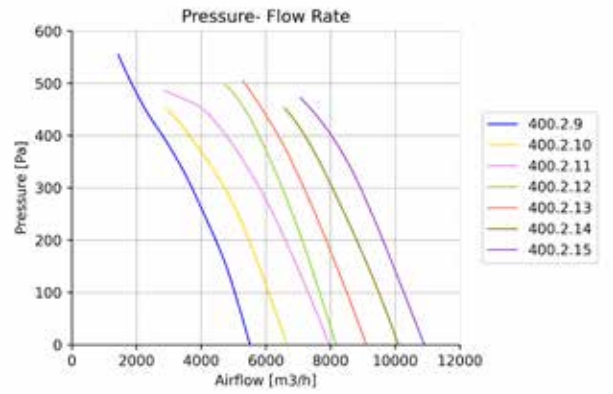

Ø450 / 3-4-6 Blade

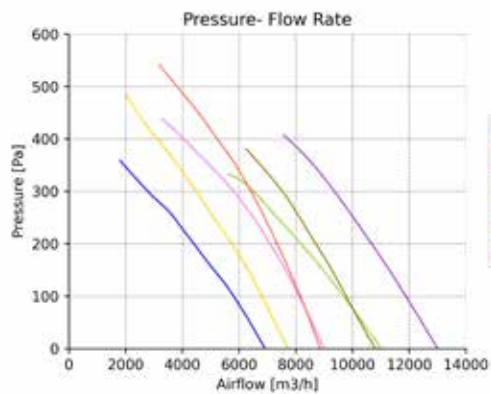

Ø450 / 5-6-8 Blade

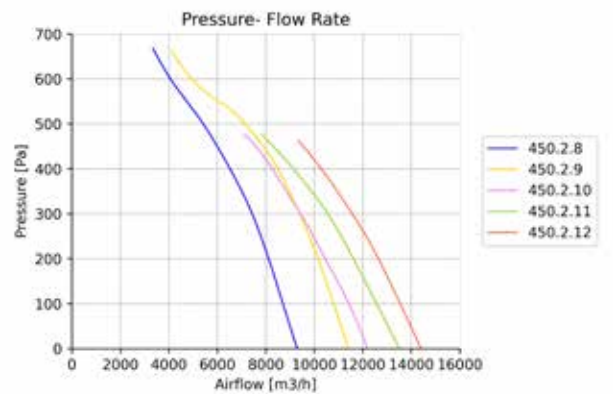

Ø450 / 10 Blade

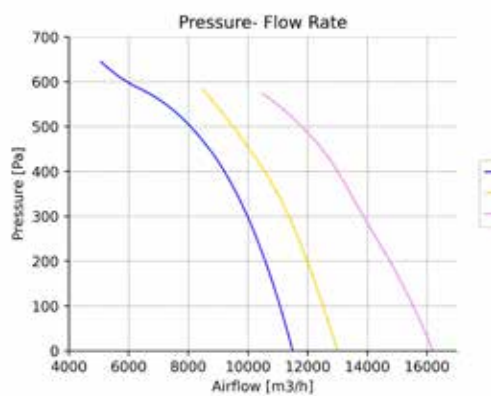

Ø500 / 3-4 Blade

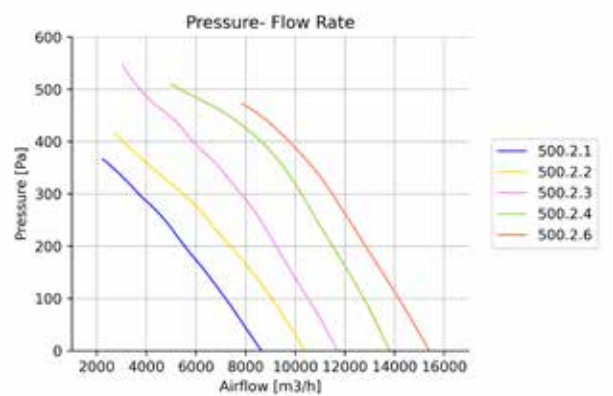

OWL RWA - SYSTEM CURVE - 2 POLES

Ø500 / 5 Blade

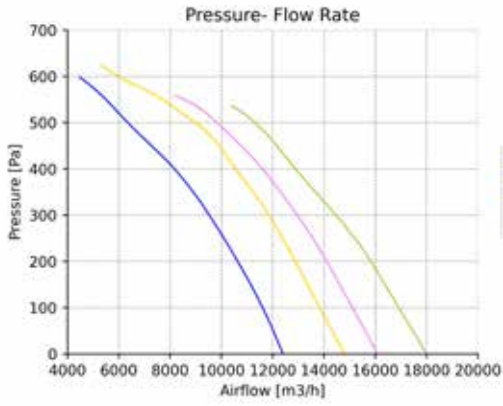

Ø500 / 10 Blade

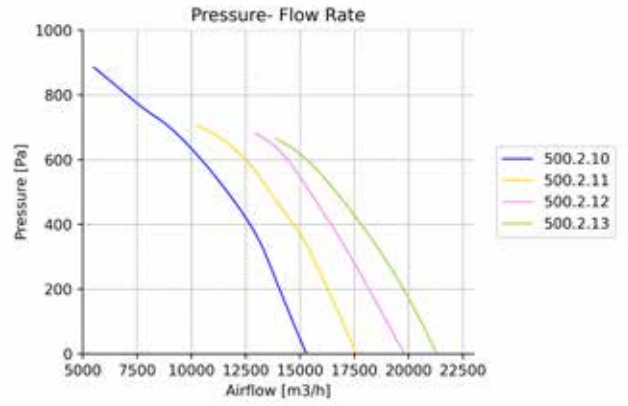

Ø560 / 3-4-5 Blade

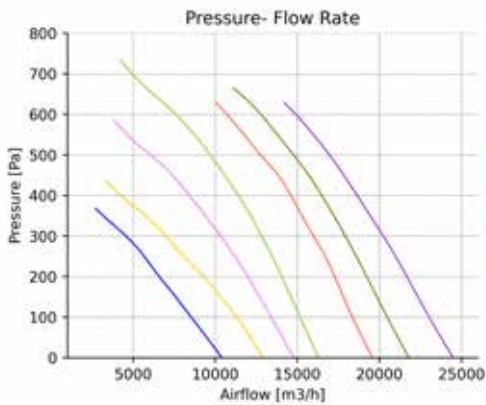

Ø560 / 6 Blade

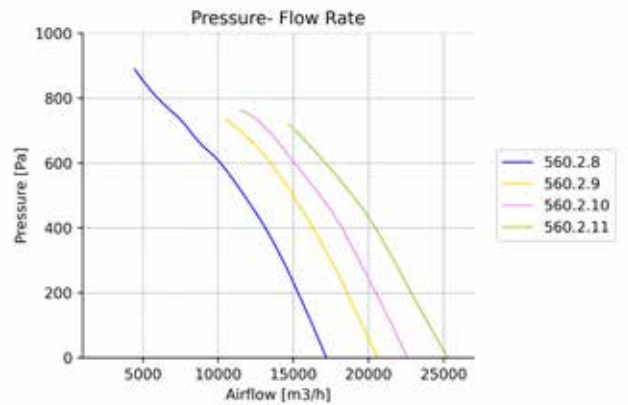

Ø560 / 10 Blade

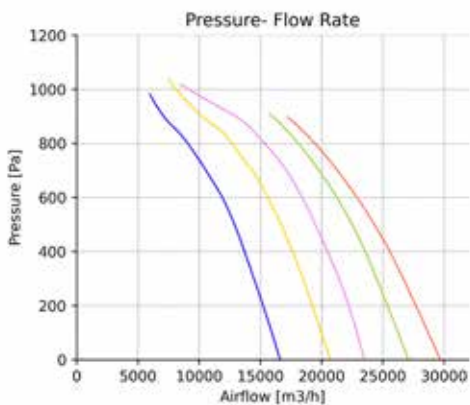

Ø630 / 3-4-5-6 Blade

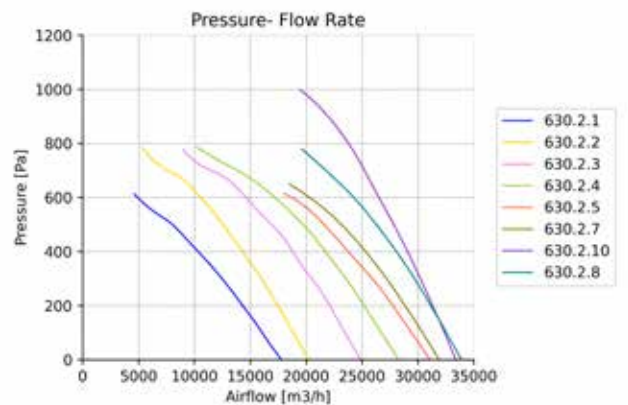

OWL RWA - SYSTEM CURVE - 2 POLES

Ø630 / 6-10-12 Blade

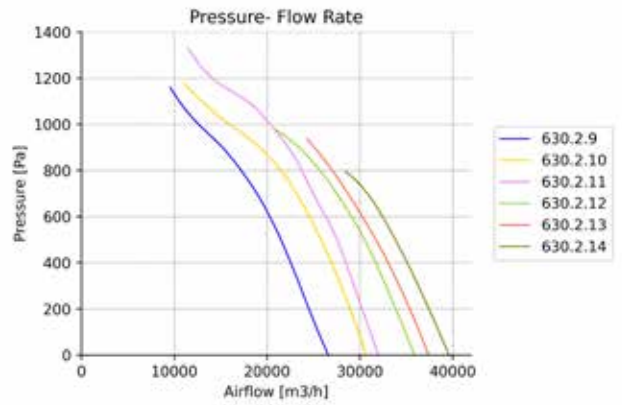

Ø710 / 3-6 Blade

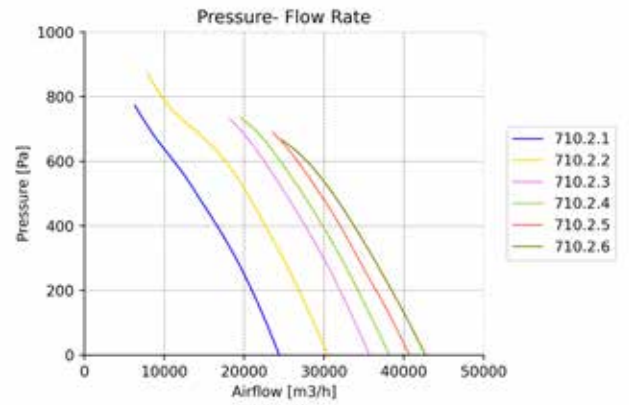

Ø710 / 6-12 Blade

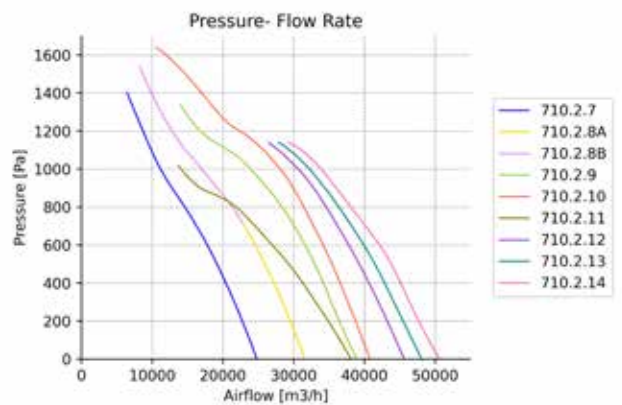

Ø800 / 3-6 Blade

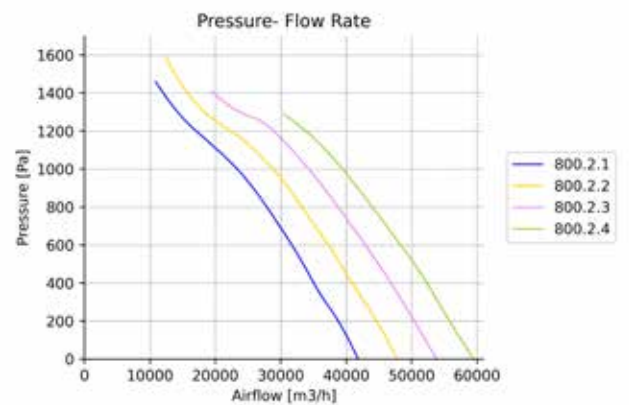

Ø800 / 6-6 Blade

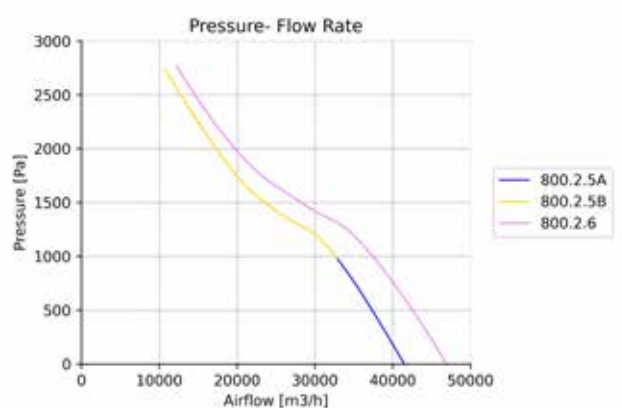

OWL RWA - SYSTEM CURVE - 4 POLES

Ø315 / 3-6 Blade

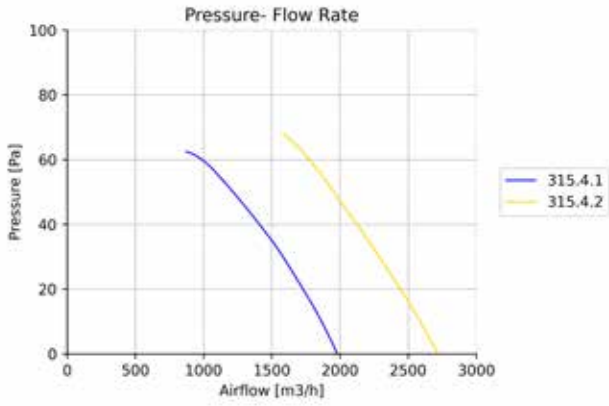

Ø355 / 4-6 Blade

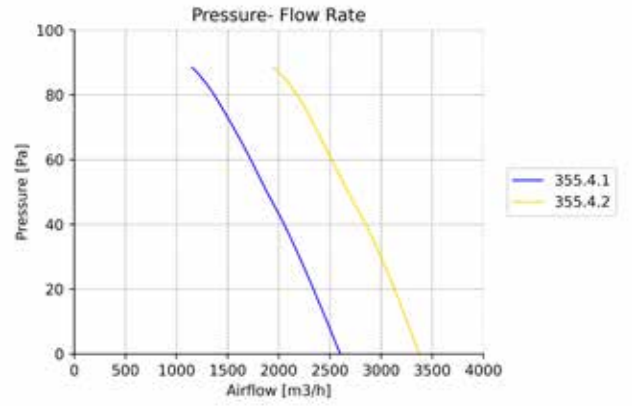

Ø400 / 6-8 Blade

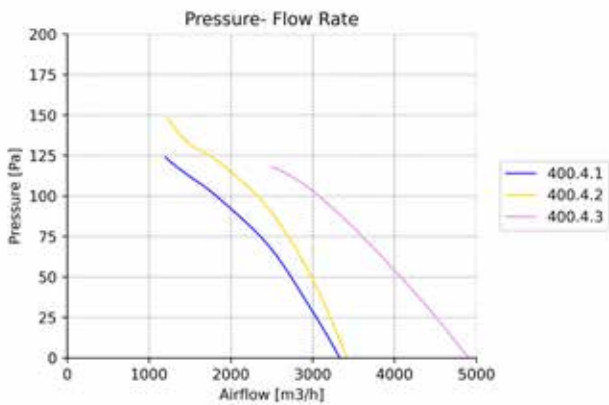

Ø450 / 6-8-10 Blade

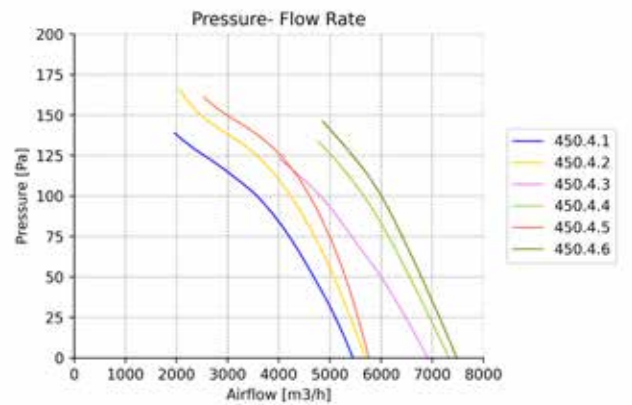

Ø500 / 6-8-10-12 Blade

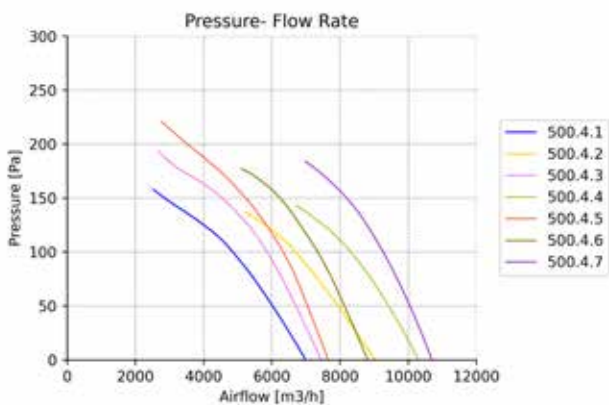

Ø560 / 3-4-6-8 Blade

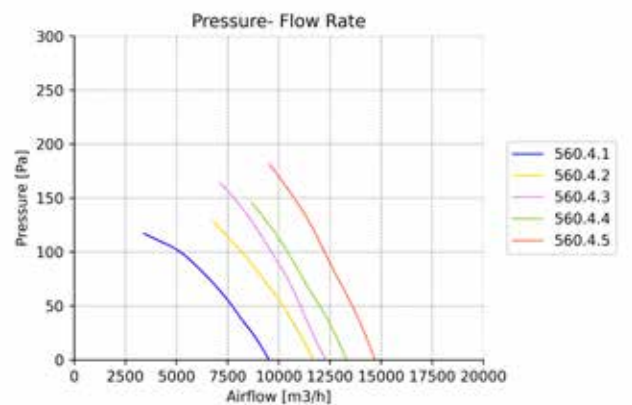

OWL RWA - SYSTEM CURVE - 4 POLES

Ø560 / 10-12 Blade

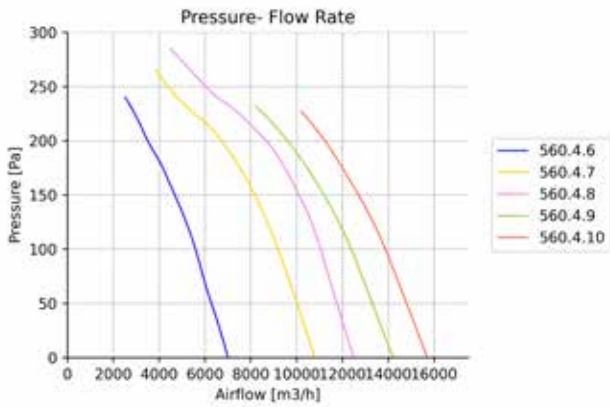

Ø630 / 5-6-8 Blade

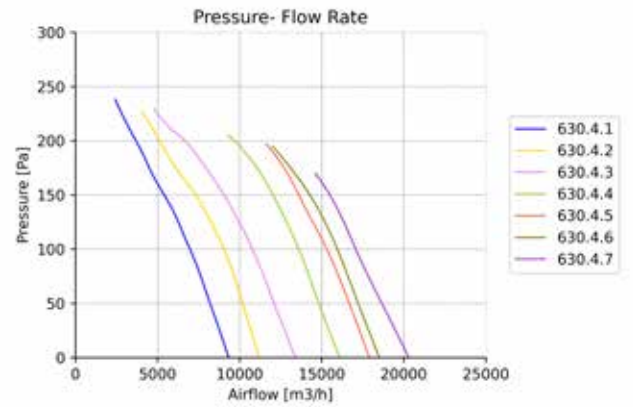

Ø630 / 10-12 Blade

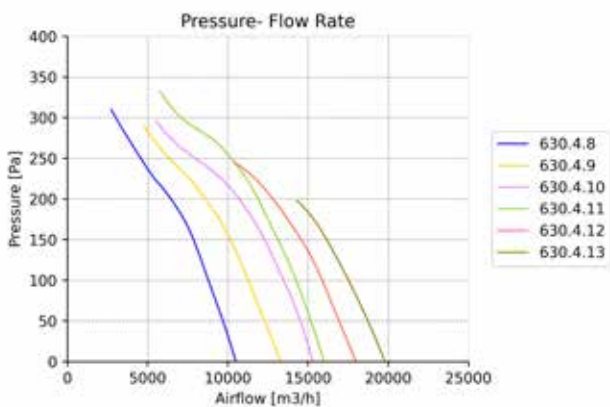

Ø630 / 9-12 Blade

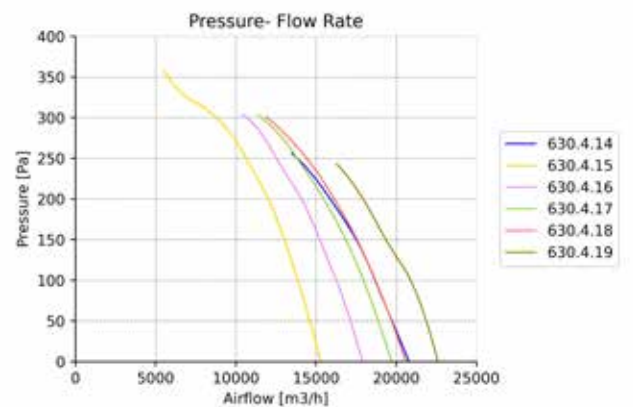

Ø710 / 5-6 Blade

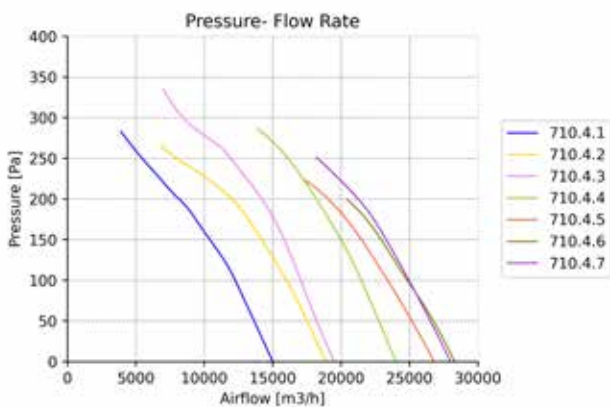

Ø710 / 9-12 Blade

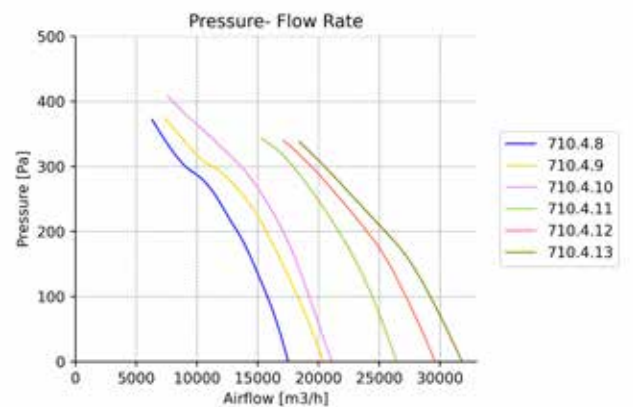

OWL RWA - SYSTEM CURVE - 4 POLES

Ø800 / 6 Blade

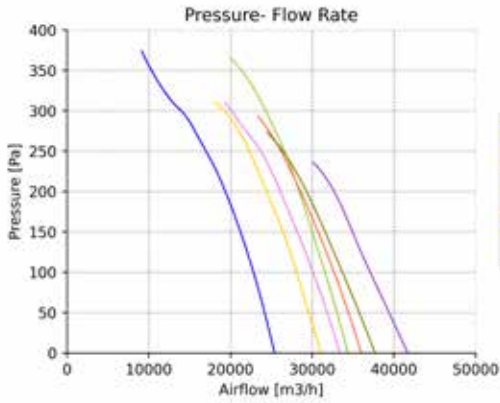

Ø800 / 8 Blade

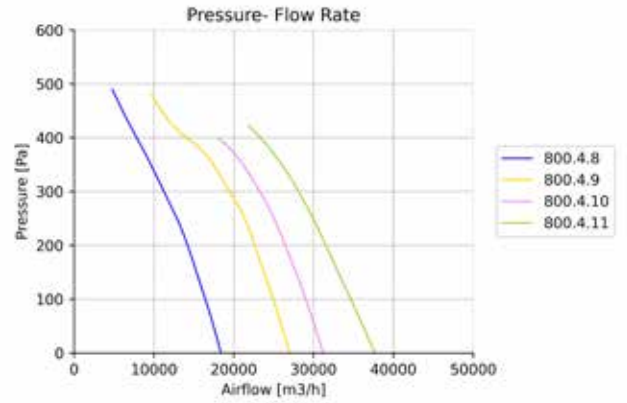

Ø800 / 9-12 Blade

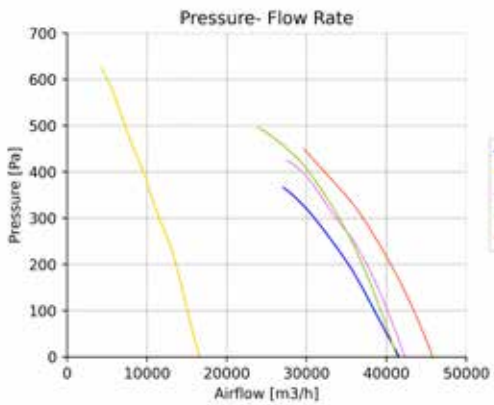

Ø800 / 6 Blade

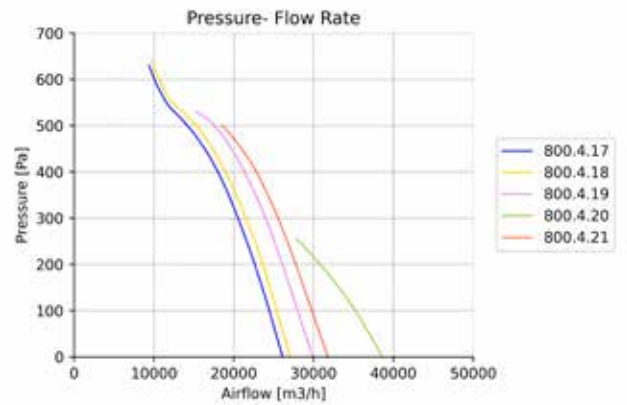

Ø900 / 6 Blade

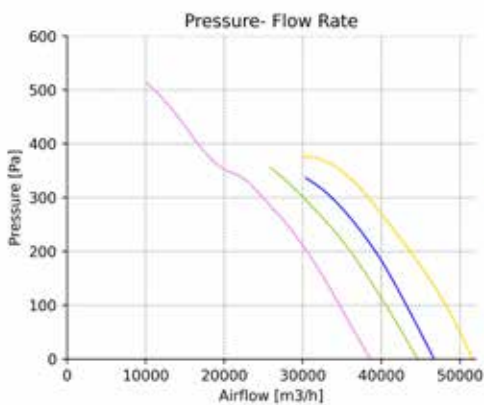

Ø900 / 8 Blade

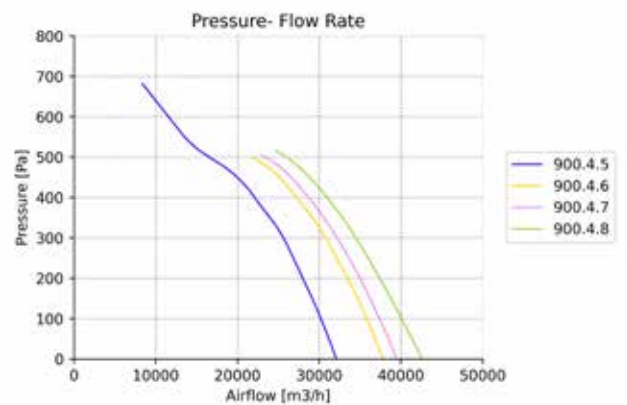

OWL RWA - SYSTEM CURVE - 4 POLES

Ø900 / 9 Blade

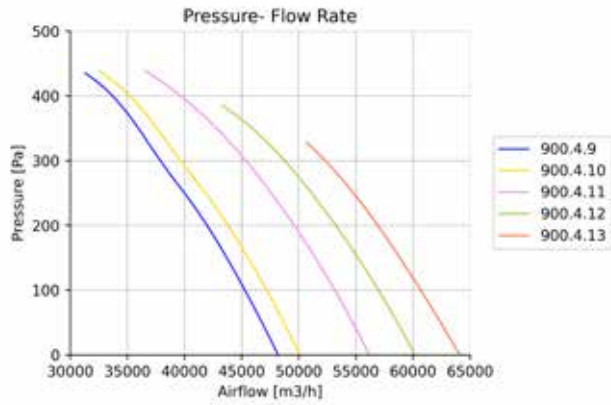

Ø900 / 12 Blade

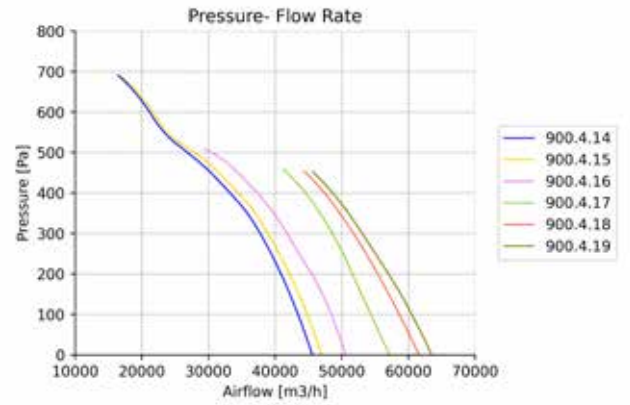

Ø900 / 6 Blade

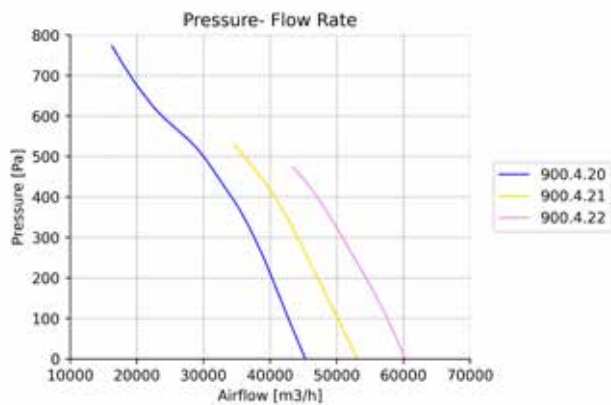

Ø1000 / 3 Blade

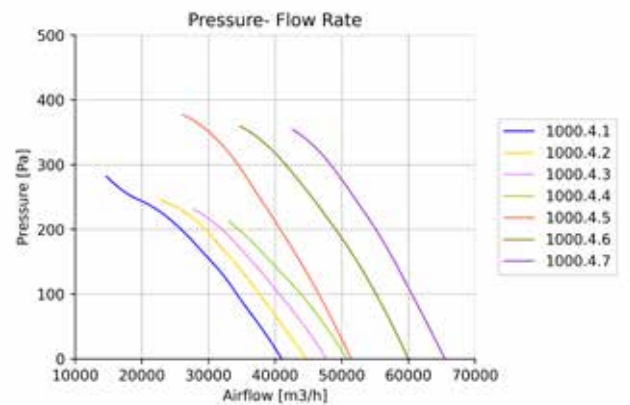

Ø1000 / 5-6 Blade

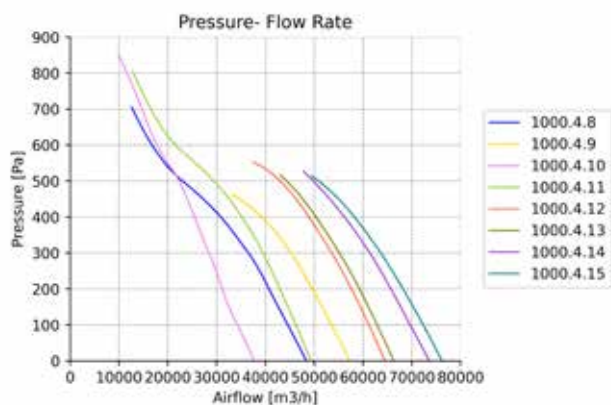

Ø1000 / 6 Blade

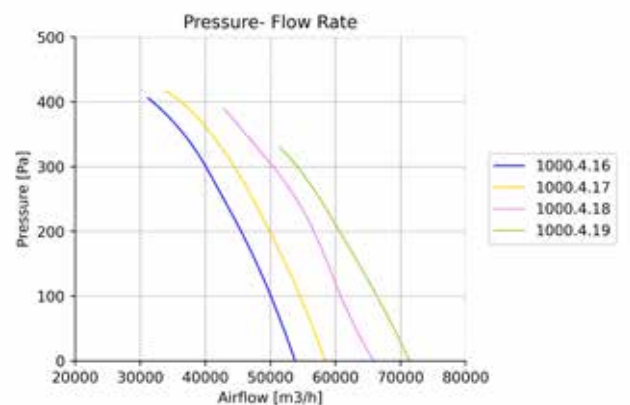

OWL RWA - SYSTEM CURVE - 4 POLES

Ø1000 / 6 Blade

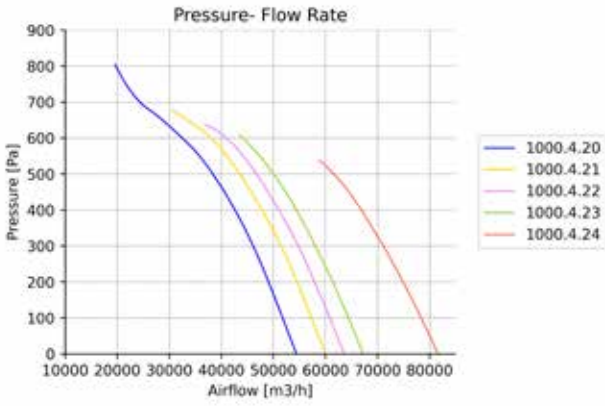

Ø1000 / 8 Blade

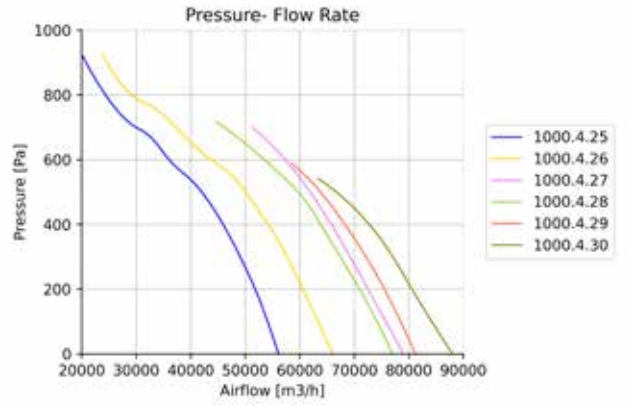

Ø1000 / 9 Blade

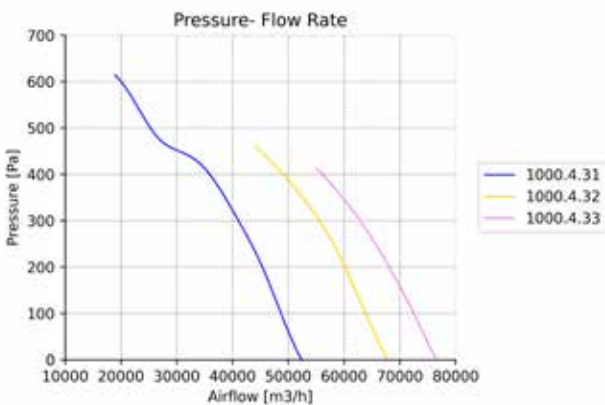

Ø1000 / 10 Blade

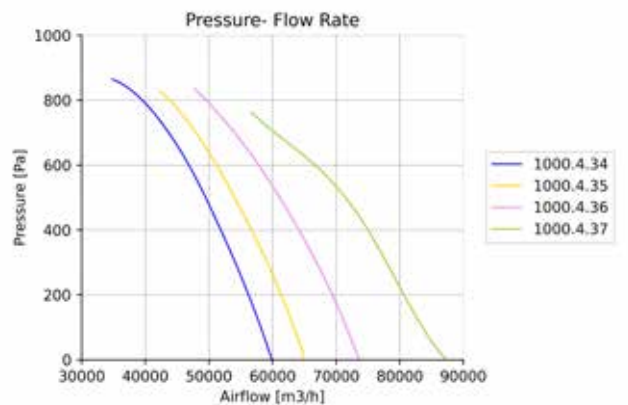

Ø1120 / 3 Blade

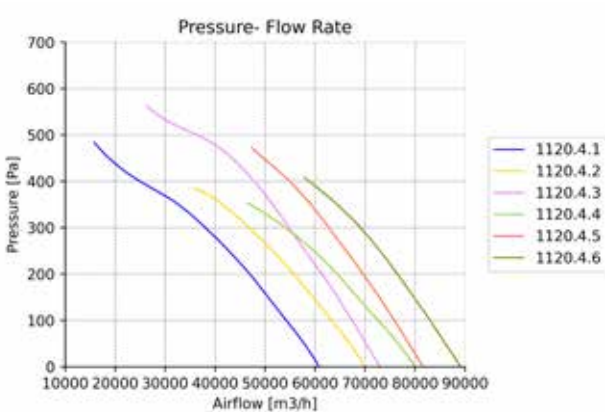

Ø1120 / 6 Blade

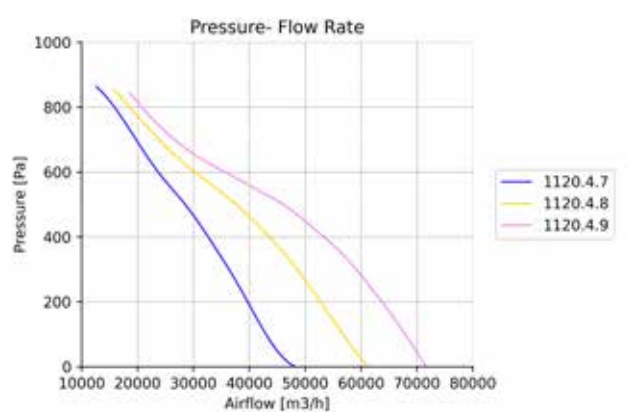

OWL RWA - SYSTEM CURVE - 4 POLES

Ø1120 / 6 Blade

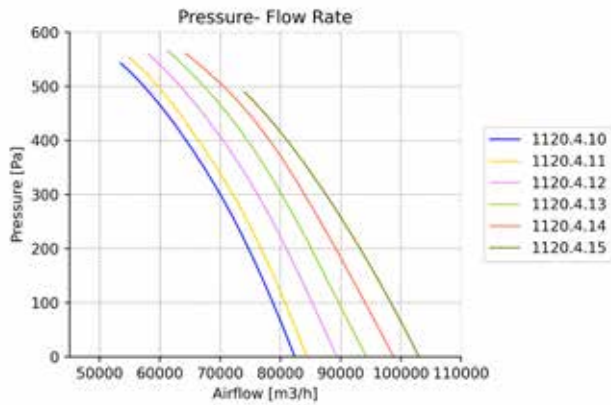

Ø1120 / 6 Blade

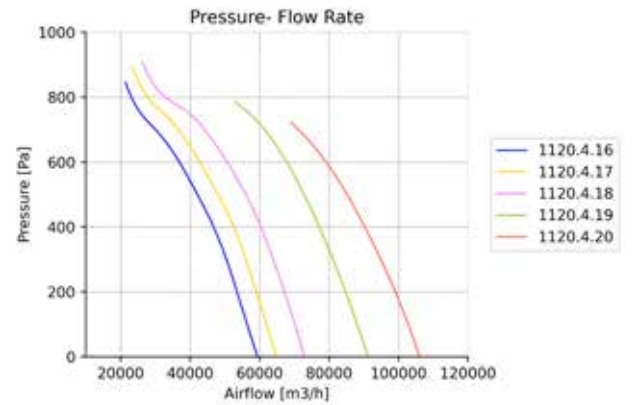

Ø1120 / 8 Blade

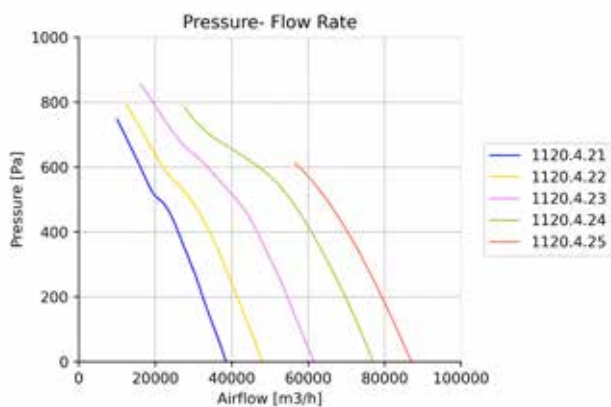

Ø1120 / 8 Blade

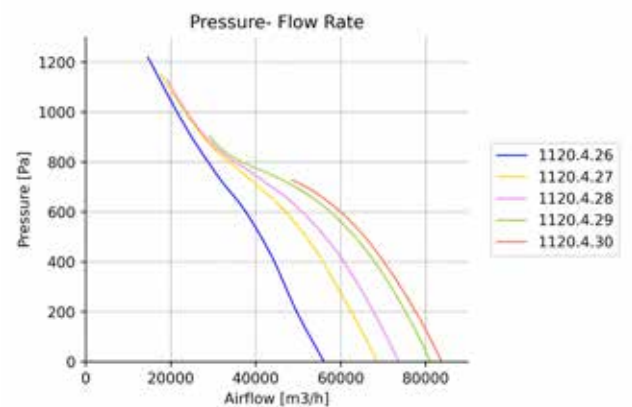

Ø1120 / 8 Blade

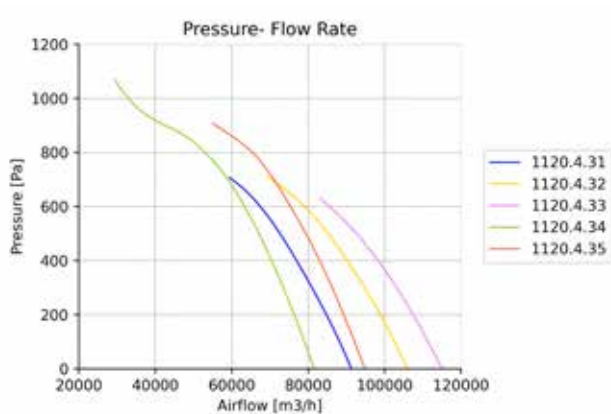

Ø1120 / 10-12 Blade

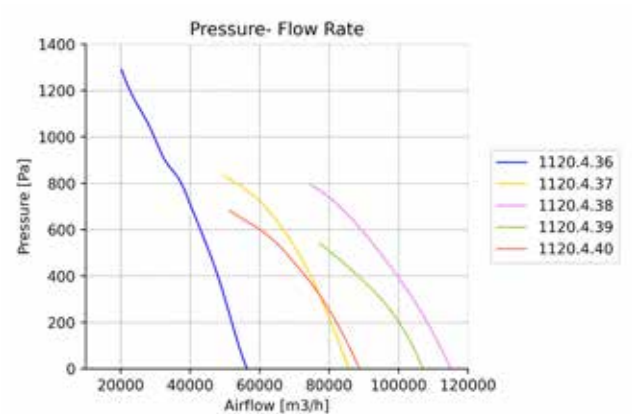

OWL RWA - SYSTEM CURVE - 4 POLES

Ø1250 / 3 Blade

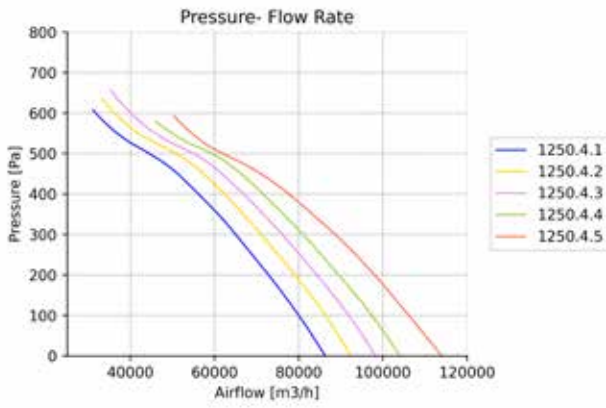

Ø1250 / 6 Blade

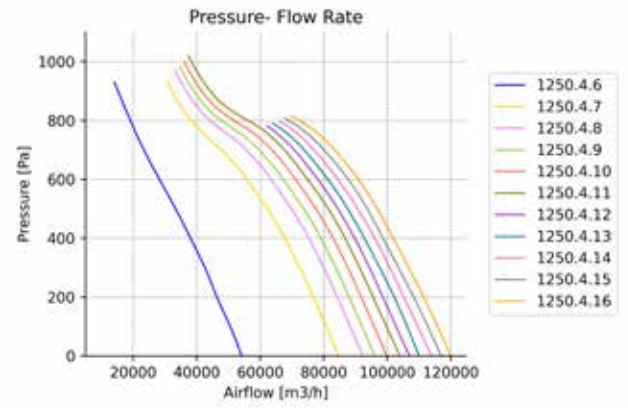

Ø1250 / 6 Blade

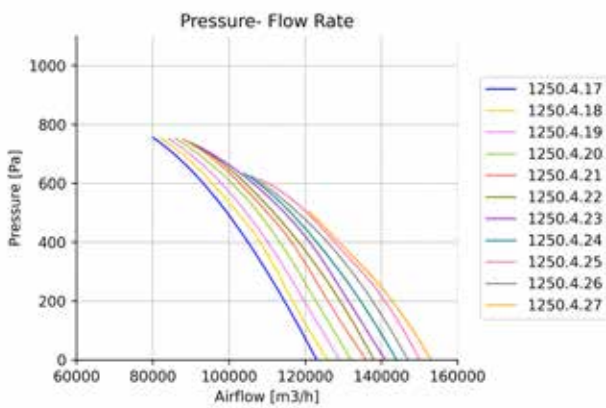

Ø1250 / 8 Blade

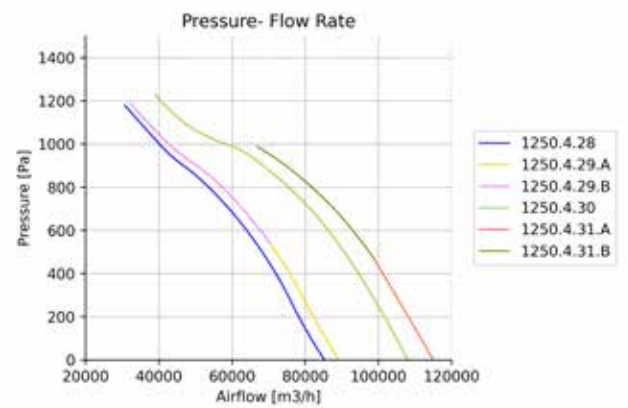

Ø1250 / 8 Blade

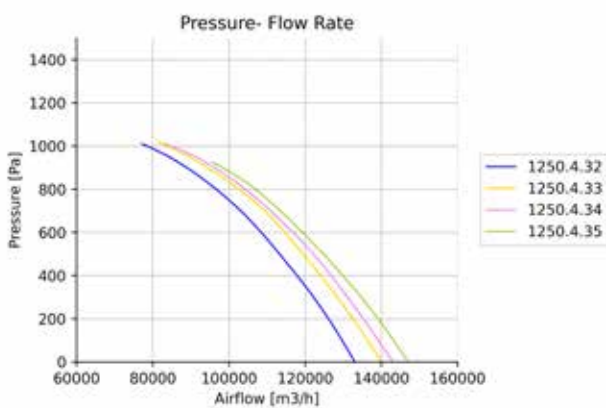

Ø1250 / 5 Blade

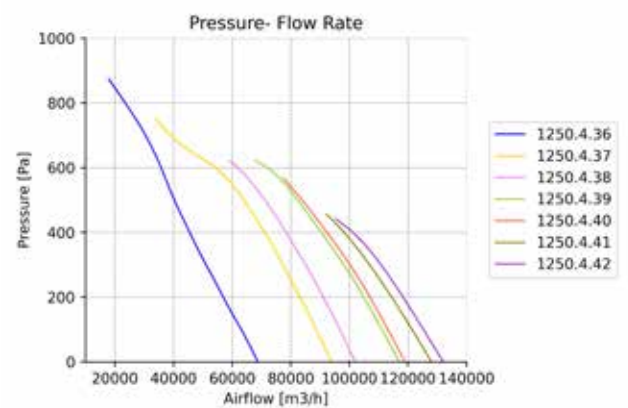

PRODUCT DIMENSIONS

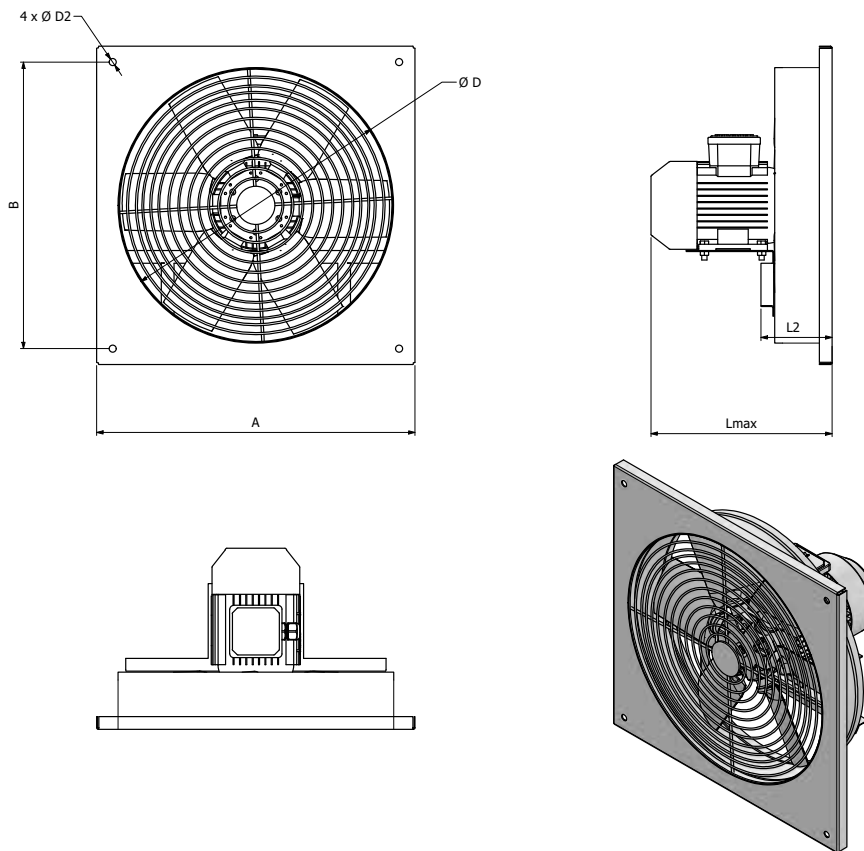

MODEL	ØD	A	kW	maks. L	L2	B	4xØD2
OWL RWA 315	315	415	0,75	390	250	350	8
OWL RWA 355	355	455	0,75	390	250	400	8
OWL RWA 355	355	455	0,75	390	250	400	8
OWL RWA 355	355	455	1,1	445	250	400	8
OWL RWA 355	355	455	1,5	445	250	400	8
OWL RWA 400	400	500	0,75	390	250	440	8
OWL RWA 400	400	500	1,1	445	250	440	8
OWL RWA 400	400	500	1,1	445	250	440	8
OWL RWA 400	400	500	1,5	445	250	440	8
OWL RWA 400	400	500	2,2	520	250	440	8
OWL RWA 400	400	500	3	520	250	440	8
OWL RWA 450	450	550	1,1	445	250	500	8
OWL RWA 450	450	550	1,5	445	250	500	8
OWL RWA 450	450	550	2,2	520	250	500	8
OWL RWA 450	450	550	2,2	520	250	500	8
OWL RWA 450	450	550	3	520	250	500	8
OWL RWA 450	450	550	4	530	250	500	8
OWL RWA 450	450	550	5,5	570	250	500	8
OWL RWA 500	500	640	0,75	390	250	570	8
OWL RWA 500	500	640	1,1	445	250	570	8

MODEL	ØD	A	kW	maks. L	L2	B	4xØD2
OWL RWA 500	500	600	2,2	520	250	570	8
OWL RWA 500	500	600	2,2	520	250	570	8
OWL RWA 500	500	600	3	520	250	570	8
OWL RWA 500	500	600	4	530	250	570	8
OWL RWA 500	500	600	5,5	570	250	570	8
OWL RWA 500	500	600	7,5	610	250	570	8
OWL RWA 560	560	700	0,75	390	250	640	10
OWL RWA 560	560	700	0,75	390	250	640	10
OWL RWA 560	560	700	1,1	445	250	640	10
OWL RWA 560	560	700	1,1	445	250	640	10
OWL RWA 560	560	700	1,5	445	250	640	10
OWL RWA 560	560	700	2,2	520	250	640	10
OWL RWA 560	560	700	3	520	250	640	10
OWL RWA 560	560	700	4	530	250	640	10
OWL RWA 560	560	700	5,5	570	250	640	10
OWL RWA 560	560	700	7,5	610	250	640	10
OWL RWA 560	560	700	7,5	610	250	640	10
OWL RWA 560	560	700	11	710	250	640	10
OWL RWA 630	630	770	1,1	445	250	730	10
OWL RWA 630	630	770	1,5	445	250	730	10
OWL RWA 630	630	770	1,5	445	250	730	10
OWL RWA 630	630	770	1,5	445	250	730	10
OWL RWA 630	630	770	2,2	520	250	730	10
OWL RWA 630	630	770	2,2	520	250	730	10
OWL RWA 630	630	770	3	520	250	730	10
OWL RWA 630	630	770	4	530	250	730	10
OWL RWA 630	630	770	5,5	570	250	730	10
OWL RWA 630	630	770	7,5	610	250	730	10
OWL RWA 630	630	770	11	710	250	730	10
OWL RWA 630	630	770	11	710	250	730	10
OWL RWA 630	630	770	11	710	250	730	10
OWL RWA 630	630	770	15	710	250	730	10
OWL RWA 710	710	850	1,5	445	300	760	10
OWL RWA 710	710	850	2,2	520	300	760	10
OWL RWA 710	710	850	3	520	300	760	10
OWL RWA 710	710	850	3	520	300	760	10
OWL RWA 710	710	850	4	530	300	760	10
OWL RWA 710	710	850	7,5	610	300	760	10
OWL RWA 710	710	850	11	710	300	760	10
OWL RWA 710	710	850	11	710	300	760	10
OWL RWA 710	710	850	15	710	300	760	10
OWL RWA 710	710	850	18,5	770	300	760	10

MODEL	ØD	A	kW	maks. L	L2	B	4xØD2
OWL RWA 800	800	940	2,2	520	350	860	10
OWL RWA 800	800	940	3	520	350	860	10
OWL RWA 800	800	940	3	520	350	860	10
OWL RWA 800	800	940	4	530	350	860	10
OWL RWA 800	800	940	4	530	350	860	10
OWL RWA 800	800	940	5,5	570	350	860	10
OWL RWA 800	800	940	5,5	570	350	860	10
OWL RWA 800	800	940	7,5	610	350	860	10
OWL RWA 800	800	940	11	710	350	860	10
OWL RWA 900	900	1040	4	530	350	1040	12
OWL RWA 900	900	1040	4	530	350	1040	12
OWL RWA 900	900	1040	5,5	570	350	1040	12
OWL RWA 900	900	1040	5,5	570	350	1040	12
OWL RWA 900	900	1040	7,5	610	350	1040	12
OWL RWA 900	900	1040	7,5	610	350	1040	12
OWL RWA 900	900	1040	7,5	610	350	1040	12
OWL RWA 900	900	1040	11	710	350	1040	12
OWL RWA 900	900	1040	11	710	350	1040	12
OWL RWA 900	900	1040	15	710	350	1040	12
OWL RWA 1000	1000	1160	5,5	570	400	1140	12
OWL RWA 1000	1000	1160	7,5	610	400	1140	12
OWL RWA 1000	1000	1160	11	710	400	1140	12
OWL RWA 1000	1000	1160	11	710	400	1140	12
OWL RWA 1000	1000	1160	11	710	400	1140	12
OWL RWA 1000	1000	1160	15	710	400	1140	12
OWL RWA 1000	1000	1160	15	710	400	1140	12
OWL RWA 1000	1000	1160	18,5	770	400	1140	12
OWL RWA 1000	1000	1160	18,5	770	400	1140	12
OWL RWA 1000	1000	1160	22	770	400	1140	12
OWL RWA 1000	1000	1160	30	860	400	1140	12
OWL RWA 1120	1120	1280	11	710	400	1210	12
OWL RWA 1120	1120	1280	15	710	400	1210	12
OWL RWA 1120	1120	1280	18,5	770	400	1210	12
OWL RWA 1120	1120	1280	22	770	400	1210	12
OWL RWA 1120	1120	1280	30	860	400	1210	12
OWL RWA 1120	1120	1280	37	930	400	1210	12
OWL RWA 1250	1250	1410	15	710	400	1340	14
OWL RWA 1250	1250	1410	18,5	770	400	1340	14
OWL RWA 1250	1250	1410	22	770	400	1340	14
OWL RWA 1250	1250	1410	30	860	400	1340	14
OWL RWA 1250	1250	1410	37	930	400	1340	14
OWL RWA 1250	1250	1410	45	930	400	1340	14
OWL RWA 1250	1250	1410	55	1010	400	1340	14

TECHNICAL PARAMETERS

MODEL	MODEL NUMBER	Voltage Frequency	Motor Power	Current	Rotation Speed	Sound Pressure	Protection Class	Working Range	Mass
		V-Hz	kW	A	RPM	Lp(A) dB at 3m	IP	°C	~ Kg
OWL RWA 315P1U-2T0,37	315.1	400-50	0,37	1,5	2880	60,1	55	-20/+50	16
OWL RWA 315P2U-2T0,37	315.2	400-50	0,37	1,5	2880	63,3	55	-20/+50	16
OWL RWA 315P3U-2T0,37	315.3	400-50	0,37	1,5	2880	63	55	-20/+50	16
OWL RWA 315P4U-2T0,37	315.4	400-50	0,37	1,5	2880	65	55	-20/+50	16
OWL RWA 315P5U-2T0,55	315.5	400-50	0,55	1,6	2880	66,3	55	-20/+50	17
OWL RWA 315P6U-2T0,55	315.6	400-50	0,55	1,6	2880	66,3	55	-20/+50	17
OWL RWA 315P7U-2T0,37	315.7	400-50	0,37	1,5	2880	65,1	55	-20/+50	16
OWL RWA 315P8U-2T0,37	315.8	400-50	0,37	1,5	2880	66,1	55	-20/+50	16
OWL RWA 315P9U-2T0,55	315.9	400-50	0,55	1,6	2880	62,1	55	-20/+50	17
OWL RWA 315P10U-2T0,55	315.10	400-50	0,55	1,6	2880	62,6	55	-20/+50	17
OWL RWA 315P11U-2T0,75	315.11	400-50	0,75	1,7	2880	63,9	55	-20/+50	19
OWL RWA 315P12U-2T1,1	315.12	400-50	1,1	2,3	2880	65,1	55	-20/+50	20
OWL RWA 355P1U-2T0,37	355.1	400-50	0,37	1,5	2880	61,1	55	-20/+50	18
OWL RWA 355P2U-2T0,37	355.2	400-50	0,37	1,5	2880	59,2	55	-20/+50	18
OWL RWA 355P3U-2T0,55	355.3	400-50	0,55	1,6	2880	61,9	55	-20/+50	19
OWL RWA 355P4U-2T0,55	355.4	400-50	0,55	1,6	2880	63,2	55	-20/+50	19
OWL RWA 355P5U-2T0,75	355.5	400-50	0,75	1,7	2880	65,1	55	-20/+50	21
OWL RWA 355P6U-2T0,55	355.6	400-50	0,55	1,6	2880	63,6	55	-20/+50	19
OWL RWA 355P7U-2T0,55	355.7	400-50	0,55	1,6	2880	66,9	55	-20/+50	19
OWL RWA 355P8U-2T0,75	355.8	400-50	0,75	1,7	2880	62,5	55	-20/+50	21
OWL RWA 355P9U-2T0,75	355.9	400-50	0,75	1,7	2880	63,1	55	-20/+50	21
OWL RWA 355P10U-2T1,1	355.10	400-50	1,1	2,3	2880	63,4	55	-20/+50	21
OWL RWA 355P11U-2T0,75	355.11	400-50	0,75	1,7	2880	64,2	55	-20/+50	21
OWL RWA 355P12U-2T1,5	355.12	400-50	1,5	3,3	2880	66,8	55	-20/+50	24
OWL RWA 400P1U-2T0,37	400.1	400-50	0,37	1,5	2880	65,5	55	-20/+50	19
OWL RWA 400P2U-2T0,55	400.2	400-50	0,55	1,6	2880	63,5	55	-20/+50	20
OWL RWA 400P3U-2T0,75	400.3	400-50	0,75	1,7	2880	64,8	55	-20/+50	22
OWL RWA 400P4U-2T0,75	400.4	400-50	0,75	1,7	2880	65,6	55	-20/+50	22
OWL RWA 400P5U-2T1,1	400.5	400-50	1,1	2,3	2880	68,2	55	-20/+50	24
OWL RWA 400P6U-2T1,1	400.6	400-50	1,1	2,3	2880	65,5	55	-20/+50	24
OWL RWA 400P7U-2T1,5	400.7	400-50	1,5	3,3	2880	68	55	-20/+50	27
OWL RWA 400P8U-2T2,2	400.8	400-50	2,2	4,5	2880	70,4	55	-20/+50	30
OWL RWA 400P9U-2T0,75	400.9	400-50	0,75	1,7	2880	68,6	55	-20/+50	22
OWL RWA 400P10U-2T0,75	400.10	400-50	0,75	1,7	2880	66,6	55	-20/+50	22
OWL RWA 400P11U-2T1,1	400.11	400-50	1,1	2,3	2880	65,2	55	-20/+50	24
OWL RWA 400P12U-2T1,5	400.12	400-50	1,5	3,3	2880	66,4	55	-20/+50	27
OWL RWA 400P13U-2T1,5	400.13	400-50	1,5	3,3	2880	66,2	55	-20/+50	27
OWL RWA 400P14U-2T2,2	400.14	400-50	2,2	4,5	2880	66,5	55	-20/+50	29
OWL RWA 400P15U-2T3	400.15	400-50	3	5,9	2880	69,3	55	-20/+50	37
OWL RWA 450P1U-2T0,55	450.1	400-50	0,55	1,6	2880	69	55	-20/+50	22
OWL RWA 450P2U-2T0,75	450.2	400-50	0,75	1,7	2880	72,9	55	-20/+50	24
OWL RWA 450P3U-2T1,1	450.3	400-50	1,1	2,3	2880	67,9	55	-20/+50	27
OWL RWA 450P4U-2T1,1	450.4	400-50	1,1	2,3	2880	69,3	55	-20/+50	26
OWL RWA 450P5U-2T1,1	450.5	400-50	1,1	2,3	2880	73	55	-20/+50	27
OWL RWA 450P6U-2T1,5	450.6	400-50	1,5	3,3	2880	67,3	55	-20/+50	29
OWL RWA 450P7U-2T2,2	450.7	400-50	2,2	4,5	2880	70,4	55	-20/+50	32

MODEL	MODEL NUMBER	Voltage Frequency	Motor Power	Current	Rotation Speed	Sound Pressure	Protection Class	Working Range	Mass
		V-Hz	kW	A	RPM	Lp(A) dB at 3m	IP	°C	~ Kg
OWL RWA 450P8U-2T1,5	450.8	400-50	1,5	3,3	2880	72,3	55	-20/+50	30
OWL RWA 450P9U-2T2,2	450.9	400-50	2,2	4,5	2880	70,6	55	-20/+50	32
OWL RWA 450P10U-2T2,2	450.10	400-50	2,2	4,5	2880	69,9	55	-20/+50	32
OWL RWA 450P11U-2T3	450.11	400-50	3	5,9	2880	71	55	-20/+50	39
OWL RWA 450P12U-2T4	450.12	400-50	4	7,9	2880	74,2	55	-20/+50	41
OWL RWA 450P13U-2T3	450.13	400-50	3	5,9	2880	69,4	55	-20/+50	40
OWL RWA 450P14U-2T3	450.14	400-50	3	5,9	2880	69,4	55	-20/+50	40
OWL RWA 450P15U-2T5,5	450.15	400-50	5,5	10,3	2880	70,7	55	-20/+50	57
OWL RWA 500P1U-2T0,75	500.1	400-50	0,75	1,7	2880	76,3	55	-20/+50	32
OWL RWA 500P2U-2T1,1	500.2	400-50	1,1	2,3	2880	70,8	55	-20/+50	36
OWL RWA 500P3U-2T1,5	500.3	400-50	1,5	3,3	2880	72,2	55	-20/+50	39
OWL RWA 500P4U-2T2,2	500.4	400-50	2,2	4,5	2880	70,4	55	-20/+50	41
OWL RWA 500P5U-2T2,2	500.5	400-50	2,2	4,5	2880	69,9	55	-20/+50	41
OWL RWA 500P6U-2T2,2	500.6	400-50	2,2	4,5	2880	66,8	55	-20/+50	42
OWL RWA 500P7U-2T3	500.7	400-50	3	5,9	2880	70,4	55	-20/+50	49
OWL RWA 500P8U-2T3	500.8	400-50	3	5,9	2880	74	55	-20/+50	49
OWL RWA 500P9U-2T4	500.9	400-50	4	7,9	2880	74,5	55	-20/+50	51
OWL RWA 500P10U-2T4	500.10	400-50	4	7,9	2880	72,2	55	-20/+50	51
OWL RWA 500P11U-2T5,5	500.11	400-50	5,5	10,3	2880	71,9	55	-20/+50	67
OWL RWA 500P12U-2T7,5	500.12	400-50	7,5	13,6	2880	72,7	55	-20/+50	74
OWL RWA 500P13U-2T7,5	500.13	400-50	7,5	13,6	2880	72,7	55	-20/+50	74
OWL RWA 560P1U-2T0,75	560.1	400-50	0,75	1,7	2880	72,7	55	-20/+50	38
OWL RWA 560P2U-2T1,1	560.2	400-50	1,1	2,3	2880	70,4	55	-20/+50	38
OWL RWA 560P3U-2T1,5	560.3	400-50	1,5	3,3	2880	73,7	55	-20/+50	41
OWL RWA 560P4U-2T2,2	560.4	400-50	3	5,9	2880	74	55	-20/+50	44
OWL RWA 560P5U-2T4	560.5	400-50	4	7,9	2880	72,7	55	-20/+50	54
OWL RWA 560P6U-2T4	560.6	400-50	4	7,9	2880	73,8	55	-20/+50	54
OWL RWA 560P7U-2T5,5	560.7	400-50	5,5	10,3	2880	75,6	55	-20/+50	69
OWL RWA 560P8U-2T3	560.8	400-50	3	5,9	2880	72,7	55	-20/+50	52
OWL RWA 560P9U-2T4	560.9	400-50	4	7,9	2880	73,2	55	-20/+50	54
OWL RWA 560P10U-2T5,5	560.10	400-50	5,5	10,3	2880	73,5	55	-20/+50	69
OWL RWA 560P11U-2T7,5	560.11	400-50	7,5	13,6	2880	75,3	55	-20/+50	76
OWL RWA 560P12U-2T4	560.12	400-50	4	7,9	2880	74,3	55	-20/+50	54
OWL RWA 560P13U-2T5,5	560.13	400-50	5,5	10,3	2880	75,7	55	-20/+50	70
OWL RWA 560P14U-2T7,5	560.14	400-50	7,5	13,6	2880	74,4	55	-20/+50	77
OWL RWA 560P15U-2T11	560.15	400-50	11	19,5	2880	75,1	55	-20/+50	103
OWL RWA 560P16U-2T11	560.16	400-50	11	19,5	2880	74,8	55	-20/+50	103
OWL RWA 630P1U-2T2,2	630.1	400-50	2,2	4,5	2880	73,7	55	-20/+50	47
OWL RWA 630P2U-2T3	630.2	400-50	3	5,9	2880	74,8	55	-20/+50	54
OWL RWA 630P3U-2T5,5	630.3	400-50	5,5	10,3	2880	73,2	55	-20/+50	72
OWL RWA 630P4U-2T5,5	630.4	400-50	5,5	10,3	2880	75,3	55	-20/+50	72
OWL RWA 630P5U-2T7,5	630.5	400-50	7,5	13,6	2880	78,5	55	-20/+50	80
OWL RWA 630P6U-2T7,5	630.6	400-50	7,5	13,6	2880	76,4	55	-20/+50	79
OWL RWA 630P7U-2T11	630.7	400-50	11	19,5	2880	78,7	55	-20/+50	107
OWL RWA 630P8U-2T11	630.8	400-50	11	19,5	2880	76,7	55	-20/+50	106
OWL RWA 630P9U-2T7,5	630.9	400-50	7,5	13,6	2880	78,4	55	-20/+50	80

MODEL	MODEL NUMBER	Voltage Frequency	Motor Power	Current	Rotation Speed	Sound Pressure	Protection Class	Working Range	Mass
		V-Hz	kW	A	RPM	Lp(A) dB at 3m	IP	°C	~ Kg
OWL RWA 630P10U-2T11	630.10	400-50	11	19,5	2880	76,6	55	-20/+50	107
OWL RWA 630P11U-2T11	630.11	400-50	11	19,5	2880	76,7	55	-20/+50	107
OWL RWA 630P12U-2T15	630.12	400-50	15	28,3	2880	76,6	55	-20/+50	121
OWL RWA 630P13U-2T15	630.13	400-50	15	28,3	2880	78,7	55	-20/+50	121
OWL RWA 630P14U-2T15	630.14	400-50	15	28,3	2880	76,5	55	-20/+50	121
OWL RWA 710P1U-2T3	710.1	400-50	3	5,9	2880	79,8	55	-20/+50	59
OWL RWA 710P2U-2T5,5	710.2	400-50	5,5	10,3	2880	77	55	-20/+50	77
OWL RWA 710P3U-2T7,5	710.3	400-50	7,5	13,6	2880	77,3	55	-20/+50	84
OWL RWA 710P4U-2T7,5	710.4	400-50	7,5	13,6	2880	78,1	55	-20/+50	84
OWL RWA 710P5U-2T11	710.5	400-50	11	19,5	2880	78,9	55	-20/+50	116
OWL RWA 710P6U-2T11	710.6	400-50	11	19,5	2880	79,9	55	-20/+50	116
OWL RWA 710P7U-2T5,5	710.7	400-50	5,5	10,3	2880	87,5	55	-20/+50	78
OWL RWA 710P8.AU-2T7,5	710.8.A	400-50	7,5	13,6	2880	83,5	55	-20/+50	85
OWL RWA 710P8.BU-2T11	710.8.B	400-50	11	19,5	2880	83,5	55	-20/+50	117
OWL RWA 710P9U-2T15	710.9	400-50	15	28,3	2880	76,4	55	-20/+50	132
OWL RWA 710P10U-2T11	710.10	400-50	11	19,5	2880	81,5	55	-20/+50	117
OWL RWA 710P11U-2T15	710.11	400-50	15	28,3	2880	78,3	55	-20/+50	133
OWL RWA 710P12U-2T15	710.12	400-50	15	28,3	2880	81,5	55	-20/+50	131
OWL RWA 710P13U-2T18,5	710.13	400-50	18,5	32,3	2880	82,5	55	-20/+50	153
OWL RWA 710P14U-2T18,5	710.14	400-50	18,5	32,3	2880	82,5	55	-20/+50	153
OWL RWA 800P1U-2T11	800.1	400-50	11	19,5	2880	82,5	55	-20/+50	128
OWL RWA 800P2U-2T15	800.2	400-50	15	28,3	2880	83,5	55	-20/+50	142
OWL RWA 800P3U-2T18,5	800.3	400-50	18,5	32,3	2880	85,5	55	-20/+50	164
OWL RWA 800P4U-2T22	800.4	400-50	22	38,3	2880	86,5	55	-20/+50	196
OWL RWA 800P5U-2T18,5	800.5	400-50	18,5	32,3	2880	86,5	55	-20/+50	159
OWL RWA 800P6U-2T18,5	800.6	400-50	18,5	32,3	2880	86,5	55	-20/+50	159
OWL RWA 800P7U-2T22	800.7	400-50	22	38,3	2880	86,5	55	-20/+50	191

MODEL	MODEL NUMBER	Voltage Frequency	Motor Power	Current	Rotation Speed	Sound Pressure	Protection Class	Working Range	Mass
		V-Hz	kW	A	RPM	Lp(A) dB at 3m	IP	°C	~ Kg
OWL RWA 315P1U-4T0,37	315.1	400-50	0,37	1,13	1440	50,1	55	-20/+50	17
OWL RWA 315P2U-4T0,37	315.2	400-50	0,37	1,13	1440	50,2	55	-20/+50	18
OWL RWA 355P1U-4T0,37	355.1	400-50	0,37	1,13	1440	47,5	55	-20/+50	19
OWL RWA 355P2U-4T0,37	355.2	400-50	0,37	1,13	1440	49,1	55	-20/+50	19
OWL RWA 400P1U-4T0,37	400.1	400-50	0,37	1,13	1440	51,5	55	-20/+50	20
OWL RWA 400P2U-4T0,37	400.2	400-50	0,37	1,13	1440	51,7	55	-20/+50	20
OWL RWA 400P3U-4T0,37	400.3	400-50	0,37	1,13	1440	52,6	55	-20/+50	20
OWL RWA 450P1U-4T0,37	450.1	400-50	0,37	1,13	1440	53,7	55	-20/+50	22
OWL RWA 450P2U-4T0,37	450.2	400-50	0,37	1,13	1440	55,6	55	-20/+50	23
OWL RWA 450P3U-4T0,37	450.3	400-50	0,37	1,13	1440	55,7	55	-20/+50	22
OWL RWA 450P4U-4T0,55	450.4	400-50	0,55	1,55	1440	54,4	55	-20/+50	23
OWL RWA 450P5U-4T0,37	450.5	400-50	0,37	1,13	1440	54,4	55	-20/+50	23
OWL RWA 450P6U-4T0,55	450.6	400-50	0,55	1,55	1440	54,4	55	-20/+50	23
OWL RWA 450P7U-4T0,75	450.7	400-50	0,75	2	1440	54,5	55	-20/+50	27
OWL RWA 500P1U-4T0,37	500.1	400-50	0,37	1,13	1440	52,7	55	-20/+50	31

MODEL	MODEL NUMBER	Voltage Frequency	Motor Power	Current	Rotation Speed	Sound Pressure	Protection Class	Working Range	Mass
		V-Hz	kW	A	RPM	Lp(A) dB at 3m	IP	°C	~ Kg
OWL RWA 500P2U-4T0,55	500.2	400-50	0,55	1,55	1440	57,5	55	-20/+50	31
OWL RWA 500P3U-4T0,37	500.3	400-50	0,37	1,13	1440	58,6	55	-20/+50	31
OWL RWA 500P4U-4T0,75	500.4	400-50	0,75	2	1440	57,8	55	-20/+50	35
OWL RWA 500P5U-4T0,55	500.5	400-50	0,55	1,55	1440	58,8	55	-20/+50	32
OWL RWA 500P6U-4T0,75	500.6	400-50	0,75	2	1440	58,8	55	-20/+50	36
OWL RWA 500P7U-4T1,1	500.7	400-50	1,1	2,6	1440	59,5	55	-20/+50	41
OWL RWA 560P1U-4T0,37	560.1	400-50	0,37	1,13	1440	59,6	55	-20/+50	36
OWL RWA 560P2U-4T0,55	560.2	400-50	0,55	1,55	1440	59,2	55	-20/+50	36
OWL RWA 560P3U-4T0,75	560.3	400-50	0,75	2	1440	60,5	55	-20/+50	40
OWL RWA 560P4U-4T0,75	560.4	400-50	0,75	2	1440	61	55	-20/+50	40
OWL RWA 560P5U-4T1,1	560.5	400-50	1,1	2,6	1440	60,7	55	-20/+50	43
OWL RWA 560P6U-4T0,37	560.6	400-50	0,37	1,13	1440	61,3	55	-20/+50	37
OWL RWA 560P7U-4T0,75	560.7	400-50	0,75	2	1440	60,8	55	-20/+50	41
OWL RWA 560P8U-4T1,1	560.8	400-50	1,1	2,6	1440	59,8	55	-20/+50	44
OWL RWA 560P9U-4T1,1	560.9	400-50	1,1	2,6	1440	60,3	55	-20/+50	43
OWL RWA 560P10U-4T1,5	560.10	400-50	1,5	3,5	1440	61,2	55	-20/+50	47
OWL RWA 630P1U-4T0,55	630.1	400-50	0,55	1,55	1440	61,4	55	-20/+50	40
OWL RWA 630P2U-4T0,55	630.2	400-50	0,55	1,55	1440	61	55	-20/+50	40
OWL RWA 630P3U-4T0,75	630.3	400-50	0,75	2	1440	59,2	55	-20/+50	44
OWL RWA 630P4U-4T1,1	630.4	400-50	1,1	2,6	1440	62,6	55	-20/+50	46
OWL RWA 630P5U-4T1,5	630.5	400-50	1,5	3,5	1440	63,4	55	-20/+50	49
OWL RWA 630P6U-4T0,75	630.6	400-50	0,75	2	1440	62,2	55	-20/+50	44
OWL RWA 630P7U-4T2,2	630.7	400-50	2,2	5	1440	66,1	55	-20/+50	51
OWL RWA 630P8U-4T0,75	630.8	400-50	0,75	2	1440	62,8	55	-20/+50	44
OWL RWA 630P9U-4T0,75	630.9	400-50	0,75	2	1440	68	55	-20/+50	44
OWL RWA 630P10U-4T1,1	630.10	400-50	1,1	2,6	1440	61,5	55	-20/+50	46
OWL RWA 630P11U-4T1,5	630.11	400-50	1,5	3,5	1440	61,4	55	-20/+50	50
OWL RWA 630P12U-4T1,5	630.12	400-50	1,5	3,5	1440	62	55	-20/+50	49
OWL RWA 630P13U-4T2,2	630.13	400-50	2,2	5	1440	63	55	-20/+50	51
OWL RWA 630P14U-4T2,2	630.14	400-50	2,2	5	1440	63,1	55	-20/+50	52
OWL RWA 630P15U-4T1,5	630.15	400-50	1,5	3,5	1440	66,3	55	-20/+50	50
OWL RWA 630P16U-4T2,2	630.16	400-50	2,2	5	1440	66,2	55	-20/+50	52
OWL RWA 630P17U-4T2,2	630.17	400-50	2,2	5	1440	66,1	55	-20/+50	52
OWL RWA 630P18U-4T2,2	630.18	400-50	2,2	5	1440	66,4	55	-20/+50	52
OWL RWA 630P19U-4T3	630.19	400-50	3	6,6	1440	67,8	55	-20/+50	59
OWL RWA 710P1U-4T0,75	710.1	400-50	0,75	2	1440	66,8	55	-20/+50	48
OWL RWA 710P2U-4T1,5	710.2	400-50	1,5	3,5	1440	64	55	-20/+50	53
OWL RWA 710P3U-4T1,5	710.3	400-50	1,5	3,5	1440	66,9	55	-20/+50	54
OWL RWA 710P4U-4T2,2	710.4	400-50	2,2	5	1440	67	55	-20/+50	56
OWL RWA 710P5U-4T3	710.5	400-50	3	6,6	1440	67,8	55	-20/+50	62
OWL RWA 710P6U-4T3	710.6	400-50	3	6,6	1440	68,5	55	-20/+50	62
OWL RWA 710P7U-4T3	710.7	400-50	3	6,6	1440	69,1	55	-20/+50	63
OWL RWA 710P8U-4T1,5	710.8	400-50	1,5	3,5	1440	64,8	55	-20/+50	56
OWL RWA 710P9U-4T2,2	710.9	400-50	2,2	5	1440	63,2	55	-20/+50	58
OWL RWA 710P10U-4T2,2	710.10	400-50	2,2	5	1440	68,8	55	-20/+50	57
OWL RWA 710P11U-4T3	710.11	400-50	3	6,6	1440	68	55	-20/+50	63

MODEL	MODEL NUMBER	Voltage Frequency	Motor Power	Current	Rotation Speed	Sound Pressure	Protection Class	Working Range	Mass
		V-Hz	kW	A	RPM	Lp(A) dB at 3m	IP	°C	~ Kg
OWL RWA 710P12U-4T4	710.12	400-50	4	8,4	1440	68,5	55	-20/+50	72
OWL RWA 710P13U-4T4	710.13	400-50	4	8,4	1440	67,5	55	-20/+50	70
OWL RWA 710P14U-4T5,5	710.14	400-50	5,5	11,2	1440	68,5	55	-20/+50	81
OWL RWA 800P1U-4T2,2	800.1	400-50	2,2	5	1440	71,8	55	-20/+50	61
OWL RWA 800P2U-4T3	800.2	400-50	3	6,6	1440	70	55	-20/+50	67
OWL RWA 800P3U-4T3	800.3	400-50	3	6,6	1440	69,1	55	-20/+50	67
OWL RWA 800P4U-4T4	800.4	400-50	4	8,4	1440	70,1	55	-20/+50	78
OWL RWA 800P5U-4T4	800.5	400-50	4	8,4	1440	70,3	55	-20/+50	78
OWL RWA 800P6U-4T4	800.6	400-50	4	8,4	1440	69,6	55	-20/+50	78
OWL RWA 800P7U-4T5,5	800.7	400-50	5,5	11,2	1440	71,1	55	-20/+50	89
OWL RWA 800P8U-4T5,5	800.8	400-50	5,5	11,2	1440	71,8	55	-20/+50	89
OWL RWA 800P9U-4T1,5	800.9	400-50	1,5	3,5	1440	74,2	55	-20/+50	59
OWL RWA 800P10U-4T3	800.10	400-50	3	6,6	1440	73,1	55	-20/+50	68
OWL RWA 800P11U-4T4	800.11	400-50	4	8,4	1440	71,7	55	-20/+50	79
OWL RWA 800P12U-4T5,5	800.12	400-50	5,5	11,2	1440	70,7	55	-20/+50	90
OWL RWA 800P13U-4T7,5	800.13	400-50	7,5	15,4	1440	71,7	55	-20/+50	96
OWL RWA 800P14U-4T2,2	800.14	400-50	2,2	5	1440	73,3	55	-20/+50	62
OWL RWA 800P15U-4T11	800.15	400-50	11	21,3	1440	72,1	55	-20/+50	143
OWL RWA 800P16U-4T7,5	800.16	400-50	7,5	15,4	1440	71,9	55	-20/+50	98
OWL RWA 800P17U-4T11	800.17	400-50	11	21,3	1440	72,4	55	-20/+50	143
OWL RWA 800P18U-4T4	800.18	400-50	4	8,4	1440	72,8	55	-20/+50	85
OWL RWA 800P19U-4T4	800.19	400-50	4	8,4	1440	73	55	-20/+50	85
OWL RWA 800P20U-4T5,5	800.20	400-50	5,5	11,2	1440	72,5	55	-20/+50	96
OWL RWA 800P21U-4T5,5	800.21	400-50	5,5	11,2	1440	71,9	55	-20/+50	96
OWL RWA 900P1U-4T5,5	900.1	400-50	5,5	11,2	1440	77,7	55	-20/+50	96
OWL RWA 900P2U-4T7,5	900.2	400-50	7,5	15,4	1440	71,5	55	-20/+50	103
OWL RWA 900P3U-4T4	900.3	400-50	4	8,4	1440	71,3	55	-20/+50	86
OWL RWA 900P4U-4T5,5	900.4	400-50	5,5	11,2	1440	71,4	55	-20/+50	97
OWL RWA 900P5U-4T4	900.5	400-50	4	8,4	1440	74,9	55	-20/+50	86
OWL RWA 900P6U-4T5,5	900.6	400-50	5,5	11,2	1440	74,1	55	-20/+50	97
OWL RWA 900P7U-4T7,5	900.7	400-50	7,5	15,4	1440	74,2	55	-20/+50	104
OWL RWA 900P8U-4T7,5	900.8	400-50	7,5	15,4	1440	72,7	55	-20/+50	104
OWL RWA 900P9U-4T7,5	900.9	400-50	7,5	15,4	1440	73,5	55	-20/+50	104
OWL RWA 900P10U-4T7,5	900.10	400-50	7,5	15,4	1440	74,2	55	-20/+50	104
OWL RWA 900P11U-4T11	900.11	400-50	11	21,3	1440	73,8	55	-20/+50	150
OWL RWA 900P12U-4T11	900.12	400-50	11	21,3	1440	73,9	55	-20/+50	150
OWL RWA 900P13U-4T15	900.13	400-50	15	29,8	1440	73	55	-20/+50	170
OWL RWA 900P14U-4T7,5	900.14	400-50	7,5	15,4	1440	74,1	55	-20/+50	105
OWL RWA 900P15U-4T7,5	900.15	400-50	7,5	15,4	1440	76,9	55	-20/+50	105
OWL RWA 900P16U-4T11	900.16	400-50	11	21,3	1440	78,8	55	-20/+50	151
OWL RWA 900P17U-4T15	900.17	400-50	15	29,8	1440	74,7	55	-20/+50	172
OWL RWA 900P18U-4T15	900.18	400-50	15	29,8	1440	74,5	55	-20/+50	172
OWL RWA 900P19U-4T15	900.19	400-50	15	29,8	1440	75,3	55	-20/+50	172
OWL RWA 900P20U-4T11	900.20	400-50	11	21,3	1440	74,4	55	-20/+50	156
OWL RWA 900P21U-4T11	900.21	400-50	11	21,3	1440	74,4	55	-20/+50	156
OWL RWA 900P22U-4T15	900.22	400-50	15	29,8	1440	72,6	55	-20/+50	176

MODEL	MODEL NUMBER	Voltage Frequency	Motor Power	Current	Rotation Speed	Sound Pressure	Protection Class	Working Range	Mass
		V-Hz	kW	A	RPM	Lp(A) dB at 3m	IP	°C	~ Kg
OWL RWA 1000P1U-4T3	1000.1	400-50	3	6,6	1440	71,1	55	-20/+50	91
OWL RWA 1000P2U-4T3	1000.2	400-50	3	6,6	1440	72	55	-20/+50	91
OWL RWA 1000P3U-4T4	1000.3	400-50	4	8,4	1440	72,7	55	-20/+50	106
OWL RWA 1000P4U-4T4	1000.4	400-50	4	8,4	1440	73,5	55	-20/+50	106
OWL RWA 1000P5U-4T5,5	1000.5	400-50	5,5	11,2	1440	73,4	55	-20/+50	123
OWL RWA 1000P6U-4T7,5	1000.6	400-50	7,5	15,4	1440	76,7	55	-20/+50	130
OWL RWA 1000P7U-4T11	1000.7	400-50	11	21,3	1440	78,4	55	-20/+50	191
OWL RWA 1000P8U-4T5,5	1000.8	400-50	5,5	11,2	1440	72,8	55	-20/+50	124
OWL RWA 1000P9U-4T7,5	1000.9	400-50	7,5	15,4	1440	74,3	55	-20/+50	131
OWL RWA 1000P10U-4T5,5	1000.10	400-50	5,5	11,2	1440	75,9	55	-20/+50	125
OWL RWA 1000P11U-4T7,5	1000.11	400-50	7,5	15,4	1440	79	55	-20/+50	132
OWL RWA 1000P12U-4T11	1000.12	400-50	11	21,3	1440	77	55	-20/+50	191
OWL RWA 1000P13U-4T11	1000.13	400-50	11	21,3	1440	77,4	55	-20/+50	191
OWL RWA 1000P14U-4T15	1000.14	400-50	15	29,8	1440	78,8	55	-20/+50	211
OWL RWA 1000P15U-4T15	1000.15	400-50	15	29,8	1440	79,4	55	-20/+50	211
OWL RWA 1000P16U-4T7,5	1000.16	400-50	7,5	15,4	1440	76,7	55	-20/+50	125
OWL RWA 1000P17U-4T7,5	1000.17	400-50	7,5	15,4	1440	76,3	55	-20/+50	125
OWL RWA 1000P18U-4T11	1000.18	400-50	11	21,3	1440	76,3	55	-20/+50	184
OWL RWA 1000P19U-4T11	1000.19	400-50	11	21,3	1440	77	55	-20/+50	184
OWL RWA 1000P20U-4T11	1000.20	400-50	11	21,3	1440	81,5	55	-20/+50	191
OWL RWA 1000P21U-4T11	1000.21	400-50	11	21,3	1440	81,5	55	-20/+50	191
OWL RWA 1000P22U-4T15	1000.22	400-50	15	29,8	1440	80,5	55	-20/+50	211
OWL RWA 1000P23U-4T15	1000.23	400-50	15	29,8	1440	79,4	55	-20/+50	211
OWL RWA 1000P24U-4T22	1000.24	400-50	22	42,5	1440	80,5	55	-20/+50	266
OWL RWA 1000P25.AU-4T11	1000.25.A	400-50	11	21,3	1440	74,3	55	-20/+50	195
OWL RWA 1000P25.BU-4T15	1000.25.B	400-50	15	29,8	1440	74,3	55	-20/+50	215
OWL RWA 1000P26U-4T15	1000.26	400-50	15	29,8	1440	76	55	-20/+50	215
OWL RWA 1000P27U-4T22	1000.27	400-50	22	42,5	1440	77,4	55	-20/+50	270
OWL RWA 1000P28U-4T30	1000.28	400-50	30	55	1440	80,1	55	-20/+50	277
OWL RWA 1000P29U-4T22	1000.29	400-50	22	42,5	1440	78,5	55	-20/+50	270
OWL RWA 1000P30U-4T30	1000.30	400-50	30	55	1440	78,8	55	-20/+50	285
OWL RWA 1000P31U-4T7,5	1000.31	400-50	7,5	15,4	1440	79,8	55	-20/+50	126
OWL RWA 1000P32U-4T11	1000.32	400-50	11	21,3	1440	76,9	55	-20/+50	185
OWL RWA 1000P33U-4T15	1000.33	400-50	15	29,8	1440	76,4	55	-20/+50	205
OWL RWA 1000P34U-4T22	1000.34	400-50	22	42,5	1440	83,5	55	-20/+50	266
OWL RWA 1000P35U-4T22	1000.35	400-50	22	42,5	1440	83,5	55	-20/+50	266
OWL RWA 1000P36U-4T30	1000.36	400-50	30	55	1440	82,5	55	-20/+50	281
OWL RWA 1000P37U-4T37	1000.37	400-50	37	67	1440	81,5	55	-20/+50	381
OWL RWA 1120P1U-4T5,5	1120.1	400-50	5,5	11,2	1440	76,5	55	-20/+50	139
OWL RWA 1120P2U-4T7,5	1120.2	400-50	7,5	15,4	1440	77,1	55	-20/+50	146
OWL RWA 1120P3U-4T11	1120.3	400-50	11	21,3	1440	78,6	55	-20/+50	198
OWL RWA 1120P4U-4T11	1120.4	400-50	11	21,3	1440	78,8	55	-20/+50	196
OWL RWA 1120P5U-4T15	1120.5	400-50	15	29,8	1440	80,1	55	-20/+50	218
OWL RWA 1120P6U-4T18,5	1120.6	400-50	18,5	34,5	1440	81,5	55	-20/+50	258
OWL RWA 1120P7U-4T7,5	1120.7	400-50	7,5	15,4	1440	78,1	55	-20/+50	148
OWL RWA 1120P8U-4T11	1120.8	400-50	11	21,3	1440	81,5	55	-20/+50	198

MODEL	MODEL NUMBER	Voltage Frequency	Motor Power	Current	Rotation Speed	Sound Pressure	Protection Class	Working Range	Mass
		V-Hz	kW	A	RPM	Lp(A) dB at 3m	IP	°C	~ Kg
OWL RWA 1120P9U-4T11	1120.9	400-50	11	21,3	1440	80,5	55	-20/+50	198
OWL RWA 1120P10U-4T15	1120.10	400-50	15	29,8	1440	79,3	55	-20/+50	218
OWL RWA 1120P11U-4T15	1120.11	400-50	15	29,8	1440	78,8	55	-20/+50	218
OWL RWA 1120P12U-4T18,5	1120.12	400-50	18,5	34,5	1440	80,5	55	-20/+50	258
OWL RWA 1120P13U-4T22	1120.13	400-50	22	42,5	1440	81,5	55	-20/+50	273
OWL RWA 1120P14U-4T22	1120.14	400-50	22	42,5	1440	82,5	55	-20/+50	273
OWL RWA 1120P15U-4T22	1120.15	400-50	22	42,5	1440	81,5	55	-20/+50	273
OWL RWA 1120P16U-4T11	1120.16	400-50	11	21,3	1440	83,5	55	-20/+50	198
OWL RWA 1120P17U-4T15	1120.17	400-50	15	29,8	1440	83,5	55	-20/+50	218
OWL RWA 1120P18U-4T15	1120.18	400-50	15	29,8	1440	83,5	55	-20/+50	218
OWL RWA 1120P19U-4T22	1120.19	400-50	22	42,5	1440	81,5	55	-20/+50	273
OWL RWA 1120P20U-4T30	1120.20	400-50	30	55	1440	84,5	55	-20/+50	298
OWL RWA 1120P21U-4T5,5	1120.21	400-50	5,5	11,2	1440	84,5	55	-20/+50	136
OWL RWA 1120P22U-4T7,5	1120.22	400-50	7,5	15,4	1440	84,5	55	-20/+50	143
OWL RWA 1120P23U-4T11	1120.23	400-50	11	21,3	1440	80,1	55	-20/+50	192
OWL RWA 1120P24U-4T15	1120.24	400-50	15	29,8	1440	79,6	55	-20/+50	212
OWL RWA 1120P25U-4T18,5	1120.25	400-50	18,5	34,5	1440	78,6	55	-20/+50	252
OWL RWA 1120P26U-4T11	1120.26	400-50	11	21,3	1440	84,5	55	-20/+50	202
OWL RWA 1120P27U-4T15	1120.27	400-50	15	29,8	1440	84,5	55	-20/+50	222
OWL RWA 1120P28U-4T15	1120.28	400-50	15	29,8	1440	83,5	55	-20/+50	222
OWL RWA 1120P29U-4T18,5	1120.29	400-50	18,5	34,5	1440	82,5	55	-20/+50	262
OWL RWA 1120P30U-4T18,5	1120.30	400-50	18,5	34,5	1440	82,5	55	-20/+50	262
OWL RWA 1120P31U-4T22	1120.31	400-50	22	42,5	1440	82,5	55	-20/+50	277
OWL RWA 1120P32U-4T30	1120.32	400-50	30	55	1440	81,5	55	-20/+50	302
OWL RWA 1120P33U-4T37	1120.33	400-50	37	67	1440	81,5	55	-20/+50	402
OWL RWA 1120P34U-4T22	1120.34	400-50	22	42,5	1440	83,5	55	-20/+50	283
OWL RWA 1120P35U-4T30	1120.35	400-50	30	55	1440	82,5	55	-20/+50	298
OWL RWA 1120P36U-4T15	1120.36	400-50	15	29,8	1440	85,5	55	-20/+50	227
OWL RWA 1120P37U-4T22	1120.37	400-50	22	42,5	1440	82,5	55	-20/+50	282
OWL RWA 1120P38U-4T45	1120.38	400-50	45	80	1440	82,5	55	-20/+50	507
OWL RWA 1120P39U-4T22	1120.39	400-50	22	42,5	1440	78,1	55	-20/+50	269
OWL RWA 1120P40U-4T30	1120.40	400-50	30	55	1440	79,1	55	-20/+50	294
OWL RWA 1250P1U-4T11	1250.1	400-50	11	21,3	1440	84,5	55	-20/+50	211
OWL RWA 1250P2U-4T15	1250.2	400-50	15	29,8	1440	83,5	55	-20/+50	231
OWL RWA 1250P3U-4T18,5	1250.3	400-50	18,5	34,5	1440	83,5	55	-20/+50	271
OWL RWA 1250P4U-4T18,5	1250.4	400-50	18,5	34,5	1440	83,5	55	-20/+50	271
OWL RWA 1250P5U-4T22	1250.5	400-50	22	42,5	1440	83,5	55	-20/+50	286
OWL RWA 1250P6U-4T11	1250.6	400-50	11	21,3	1440	88,5	55	-20/+50	211
OWL RWA 1250P7U-4T18,5	1250.7	400-50	18,5	34,5	1440	89,5	55	-20/+50	271
OWL RWA 1250P8U-4T22	1250.8	400-50	22	42,5	1440	89,5	55	-20/+50	286
OWL RWA 1250P9U-4T22	1250.9	400-50	22	42,5	1440	89,5	55	-20/+50	286
OWL RWA 1250P10U-4T22	1250.10	400-50	22	42,5	1440	89,5	55	-20/+50	286
OWL RWA 1250P11U-4T30	1250.11	400-50	30	55	1440	87,5	55	-20/+50	317
OWL RWA 1250P12U-4T30	1250.12	400-50	30	55	1440	88,5	55	-20/+50	317
OWL RWA 1250P13U-4T30	1250.13	400-50	30	55	1440	82,5	55	-20/+50	317
OWL RWA 1250P14U-4T30	1250.14	400-50	30	55	1440	88,5	55	-20/+50	317

MODEL	MODEL NUMBER	Voltage Frequency	Motor Power	Current	Rotation Speed	Sound Pressure	Protection Class	Working Range	Mass
		V-Hz	kW	A	RPM	Lp(A) dB at 3m	IP	°C	~ Kg
OWL RWA 1250P15U-4T30	1250.15	400-50	30	55	1440	83,5	55	-20/+50	317
OWL RWA 1250P16U-4T30	1250.16	400-50	30	55	1440	84,5	55	-20/+50	317
OWL RWA 1250P17U-4T37	1250.17	400-50	37	67	1440	84,5	55	-20/+50	417
OWL RWA 1250P18U-4T37	1250.18	400-50	37	67	1440	84,5	55	-20/+50	417
OWL RWA 1250P19U-4T37	1250.19	400-50	37	67	1440	84,5	55	-20/+50	417
OWL RWA 1250P20U-4T45	1250.20	400-50	45	80	1440	84,5	55	-20/+50	517
OWL RWA 1250P21U-4T45	1250.21	400-50	45	80	1440	84,5	55	-20/+50	517
OWL RWA 1250P22U-4T45	1250.22	400-50	45	80	1440	84,5	55	-20/+50	517
OWL RWA 1250P23U-4T45	1250.23	400-50	45	80	1440	42,5	55	-20/+50	517
OWL RWA 1250P24U-4T45	1250.24	400-50	45	80	1440	85,5	55	-20/+50	517
OWL RWA 1250P25U-4T55	1250.25	400-50	55	96,8	1440	86,5	55	-20/+50	547
OWL RWA 1250P26U-4T55	1250.26	400-50	55	96,8	1440	86,5	55	-20/+50	547
OWL RWA 1250P27U-4T55	1250.27	400-50	55	96,8	1440	86,5	55	-20/+50	547
OWL RWA 1250P28U-4T22	1250.28	400-50	22	42,5	1440	89,5	55	-20/+50	286
OWL RWA 1250P29.AU-4T22	1250.29.A	400-50	22	42,5	1440	89,5	55	-20/+50	286
OWL RWA 1250P29.BU-4T30	1250.29.B	400-50	30	55	1440	89,5	55	-20/+50	317
OWL RWA 1250P30U-4T30	1250.30	400-50	30	55	1440	87,5	55	-20/+50	317
OWL RWA 1250P31.AU-4T30	1250.31.A	400-50	30	55	1440	87,5	55	-20/+50	317
OWL RWA 1250P31.BU-4T37	1250.31.B	400-50	37	67	1440	87,5	55	-20/+50	417
OWL RWA 1250P32U-4T45	1250.32	400-50	45	80	1440	85,5	55	-20/+50	517
OWL RWA 1250P33U-4T55	1250.33	400-50	55	96,8	1440	84,5	55	-20/+50	547
OWL RWA 1250P34U-4T55	1250.34	400-50	55	96,8	1440	84,5	55	-20/+50	547
OWL RWA 1250P35U-4T55	1250.35	400-50	55	96,8	1440	84,5	55	-20/+50	547
OWL RWA 1250P36U-4T11	1250.36	400-50	11	21,3	1440	77,5	55	-20/+50	216
OWL RWA 1250P37U-4T18,5	1250.37	400-50	18,5	34,5	1440	79,8	55	-20/+50	276
OWL RWA 1250P38U-4T22	1250.38	400-50	22	42,5	1440	80,4	55	-20/+50	291
OWL RWA 1250P39U-4T30	1250.39	400-50	30	55	1440	85,5	55	-20/+50	322
OWL RWA 1250P40U-4T30	1250.40	400-50	30	55	1440	86,5	55	-20/+50	322
OWL RWA 1250P41U-4T37	1250.41	400-50	37	67	1440	83,5	55	-20/+50	422
OWL RWA 1250P42U-4T37	1250.42	400-50	37	67	1440	84,5	55	-20/+50	422

ROUND WALL TYPES AXIAL FANS WITH AEROFIL BLADES



- Electrostatic oven painted body on galvanized sheet
- Blade manufactured from glass fiber composite materials
- Suitable for max. 40°C operation
- Rotational speed can be set with frequency inverter

OWL CWA - SYSTEM CURVE - 2 POLE

Ø315 / 3-4 Blade

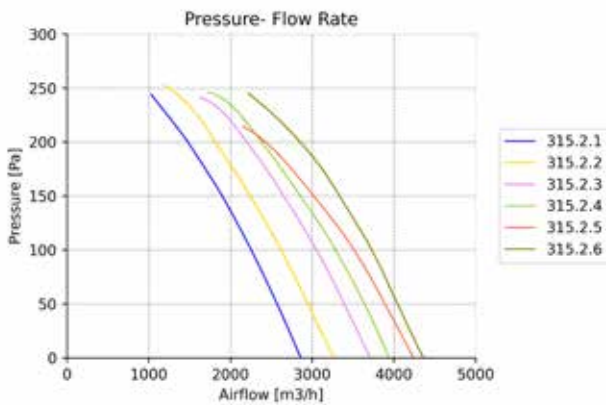

Ø315 / 6 Blade

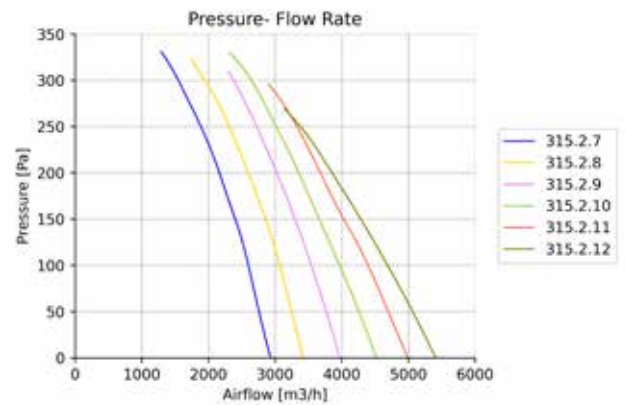

Ø355 / 3 Blade

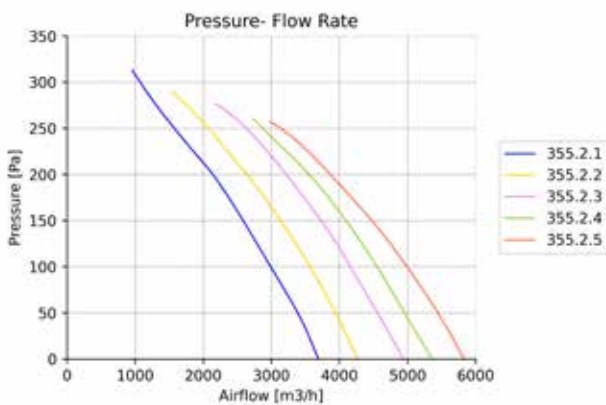

Ø355 / 4-6-8 Blade

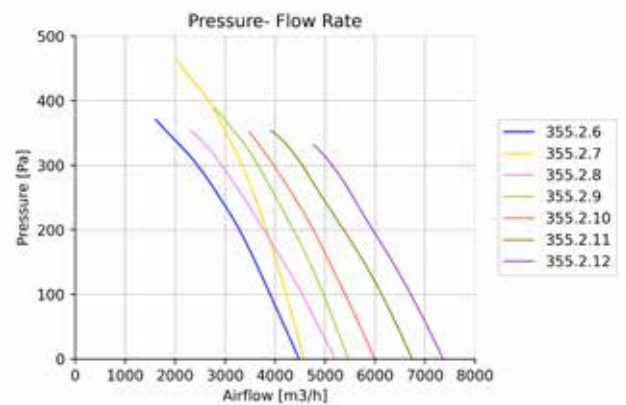

OWL CWA - SYSTEM CURVE - 2 POLE

Ø400 / 3-4-5 Blade

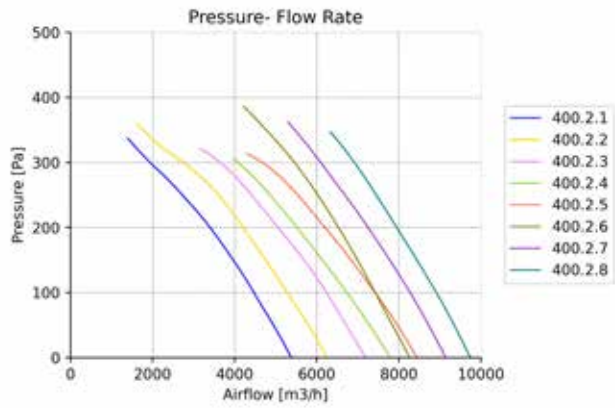

Ø400 / 6-8-10 Blade

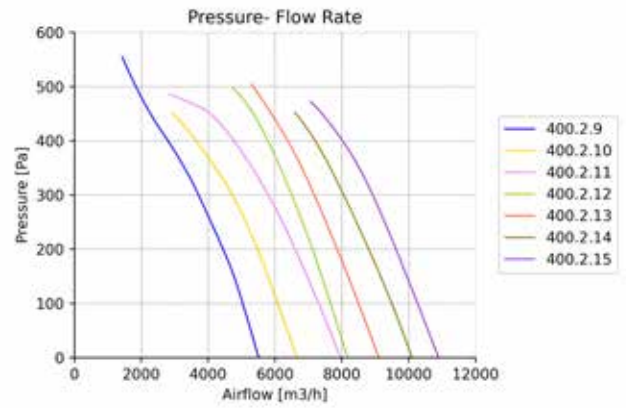

Ø450 / 3-4-6 Blade

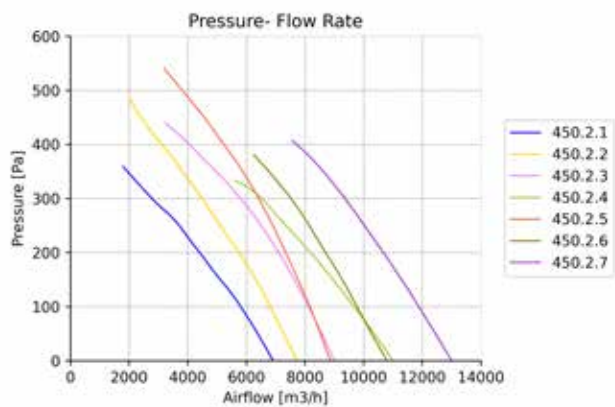

Ø450 / 5-6-8 Blade

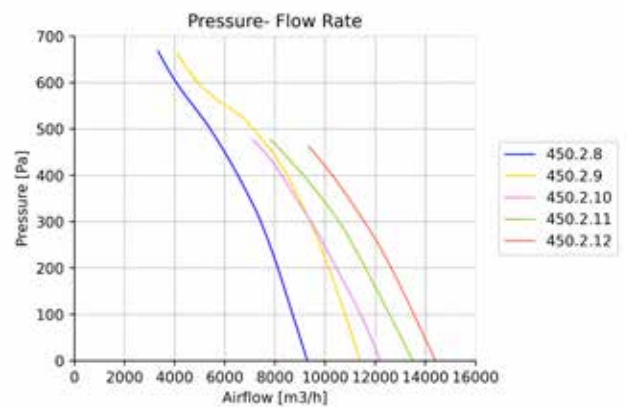

Ø450 / 10 Blade

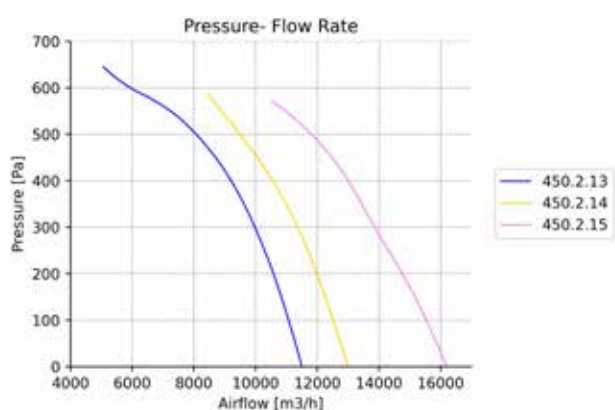

Ø500 / 3-4 Blade

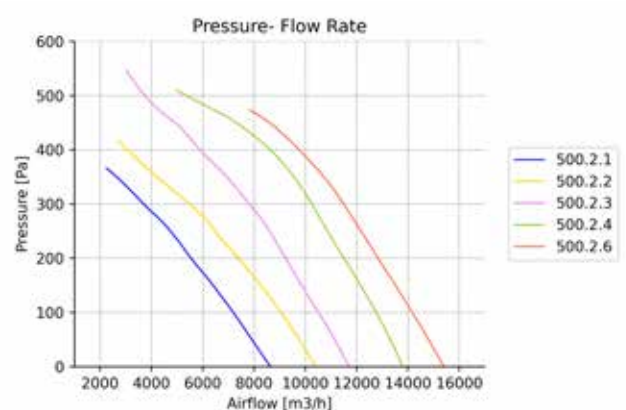

OWL CWA - SYSTEM CURVE - 2 POLES

Ø500 / 5 Blade

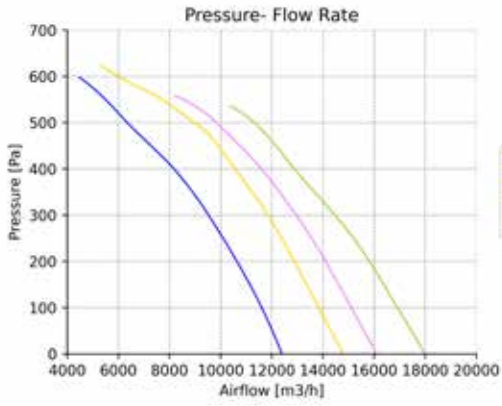

Ø500 / 10 Blade

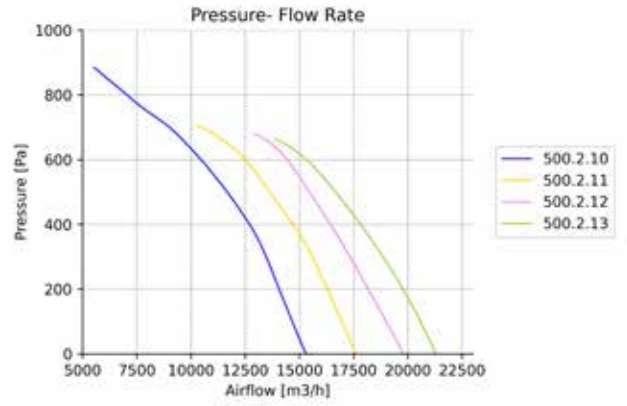

Ø560 / 3-4-5 Blade

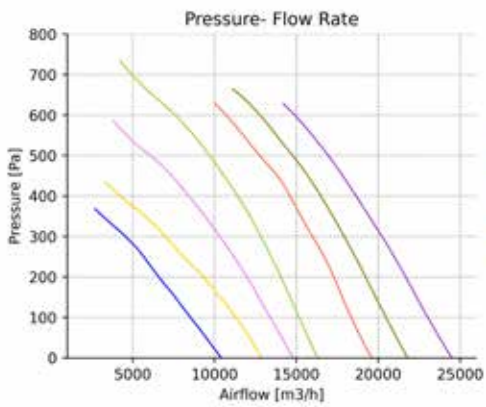

Ø560 / 6 Blade

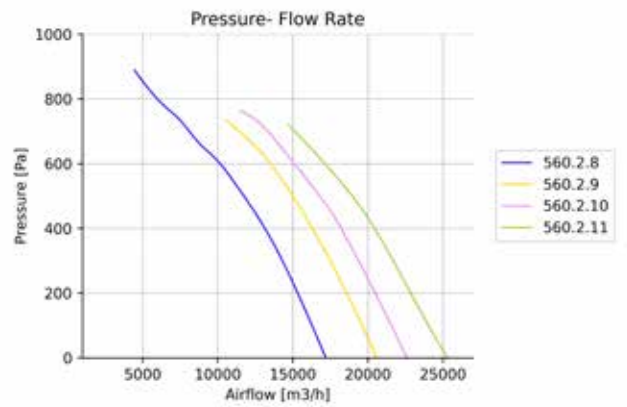

Ø560 / 10 Blade

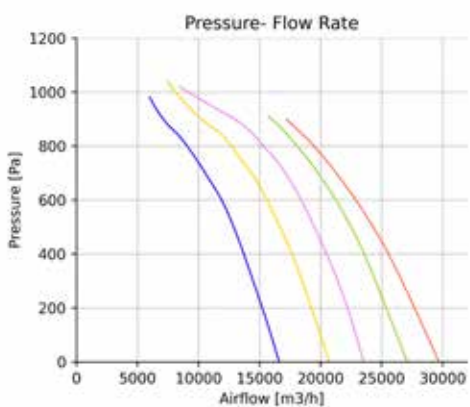

Ø630 / 3-4-5-6 Blade

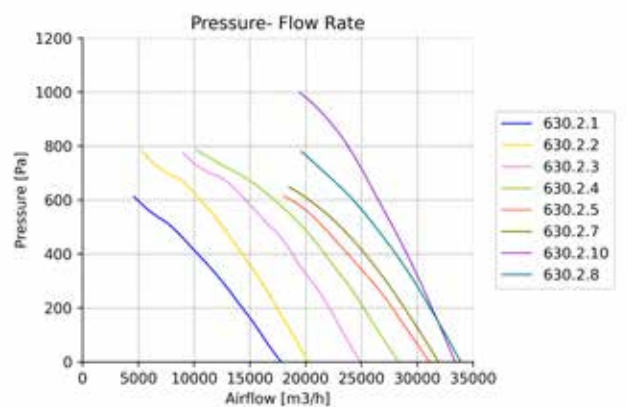

OWL CWA - SYSTEM CURVE - 2 POLES

Ø630 / 6-10-12 Blade

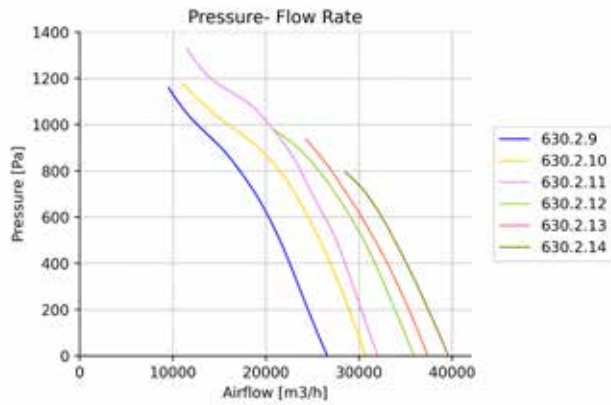

Ø710 / 3-6 Blade

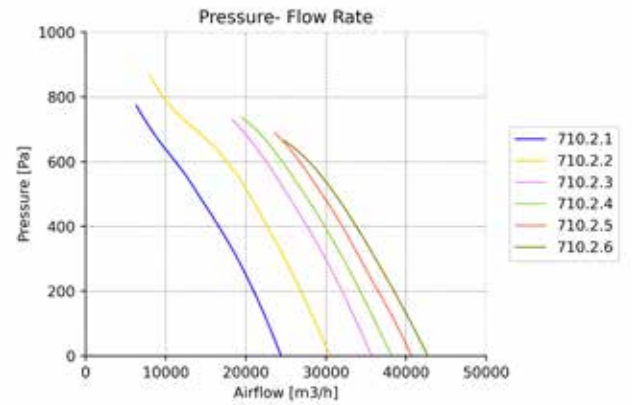

Ø710 / 6-12 Blade

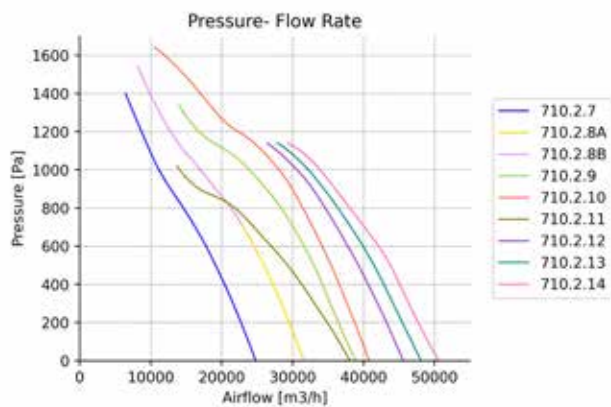

Ø800 / 3-6 Blade

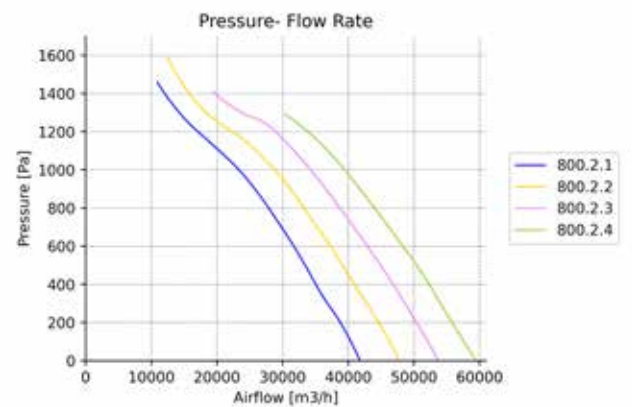

Ø800 / 6-6 Blade

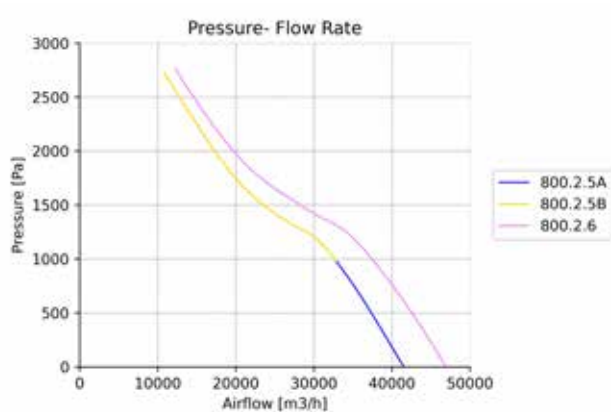

OWL CWA - SYSTEM CURVE - 4 POLES

Ø315 / 3-6 Blade

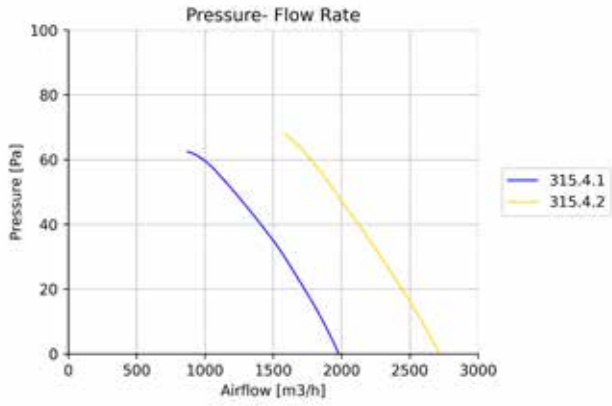

Ø355 / 4-6 Blade

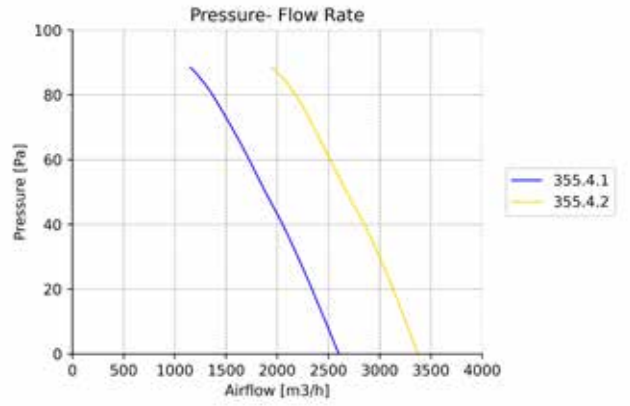

Ø400 / 6-8 Blade

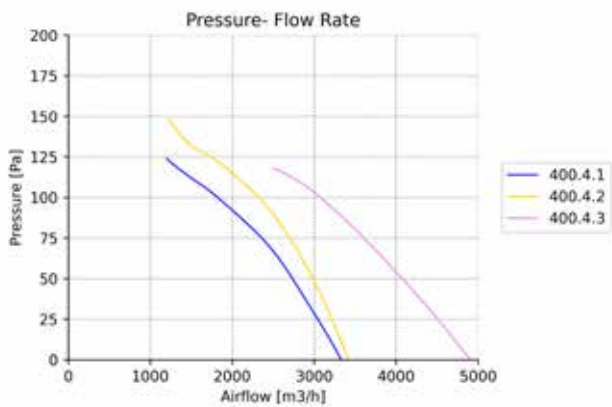

Ø450 / 6-8-10 Blade

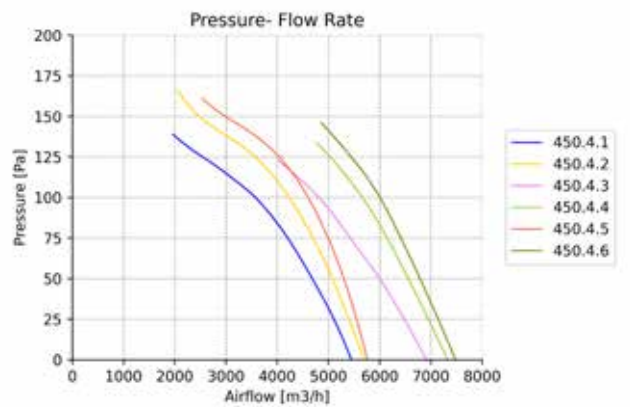

Ø500 / 6-8-10-12 Blade

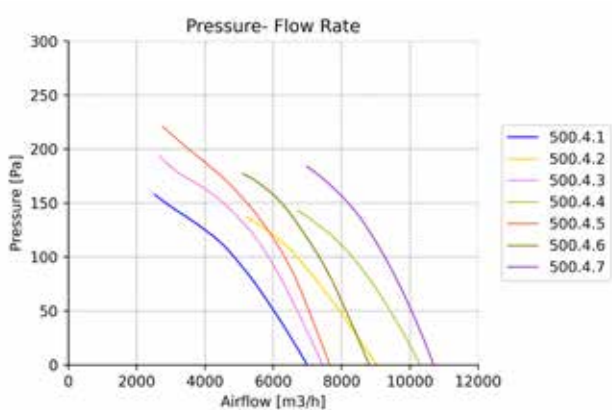

Ø560 / 3-4-6-8 Blade

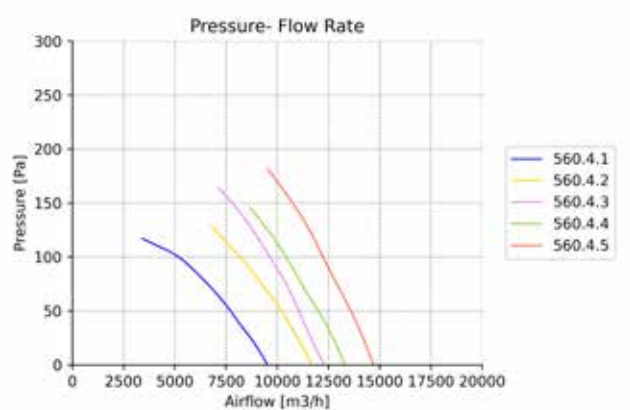

OWL CWA- SYSTEM CURVE - 4 POLES

Ø560 / 10-12 Blade

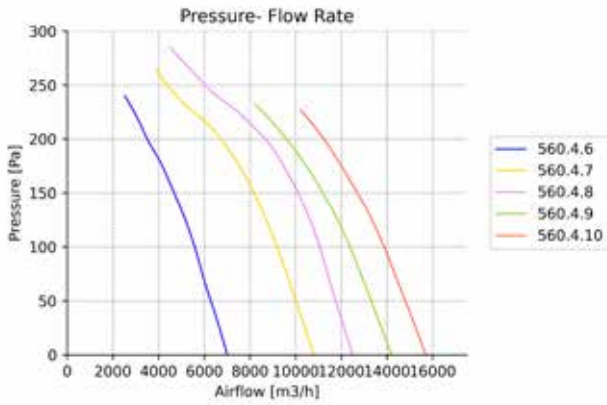

Ø630 / 5-6-8 Blade

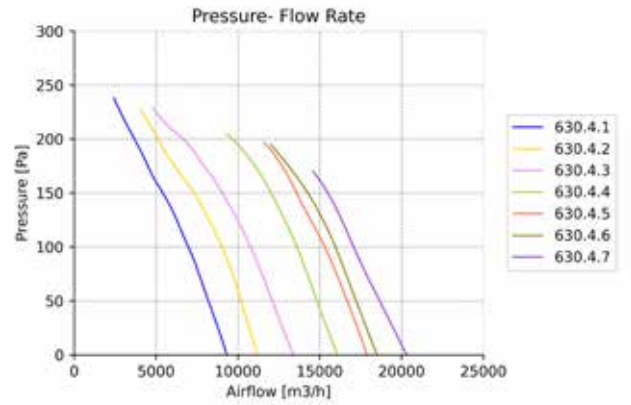

Ø630 / 10-12 Blade

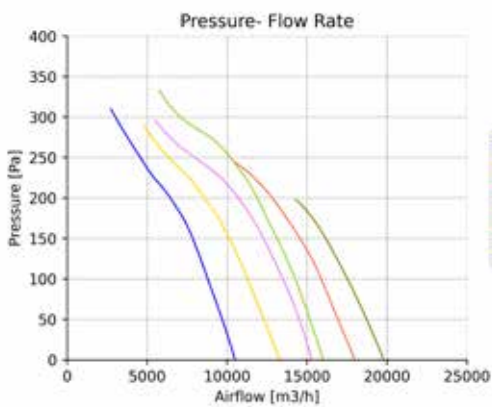

Ø630 / 9-12 Blade

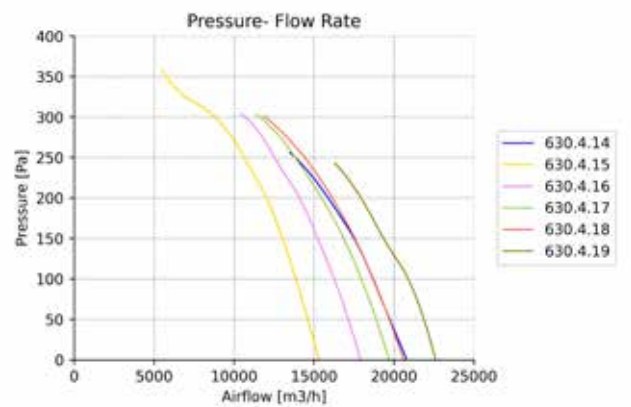

Ø710 / 5-6 Blade

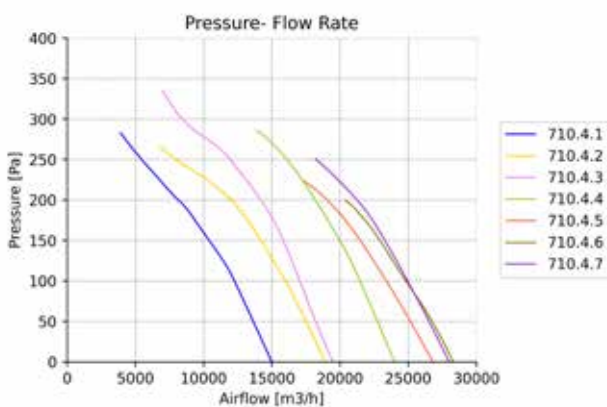

Ø710 / 9-12 Blade

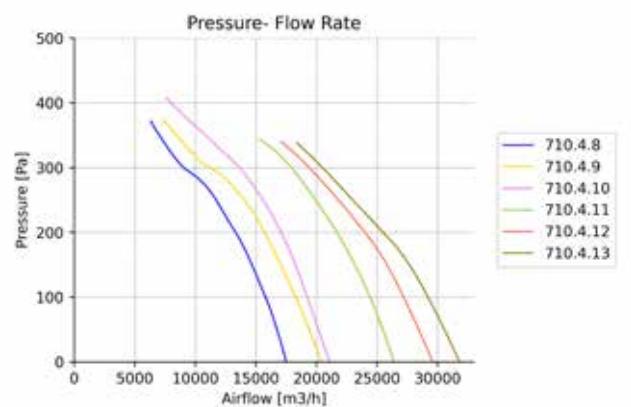

OWL CWA - SYSTEM CURVE - 4 POLES

Ø800 / 6 Blade

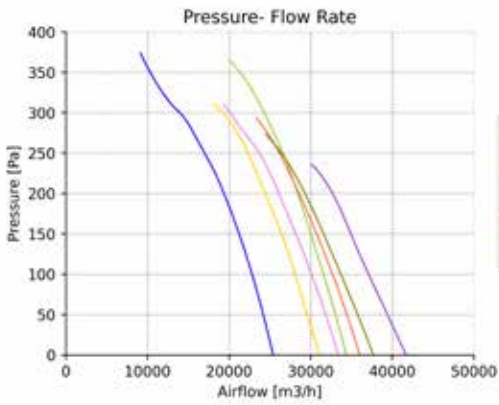

Ø800 / 8 Blade

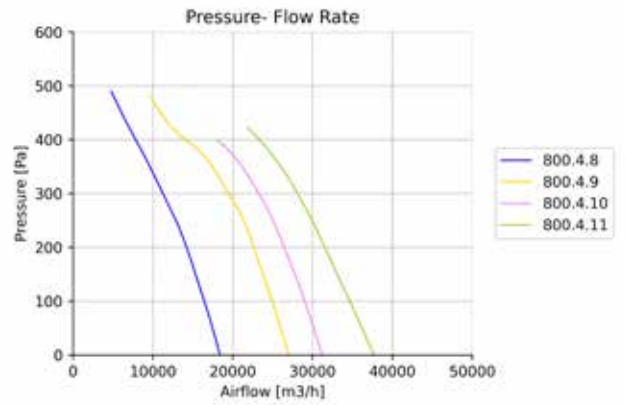

Ø800 / 9-12 Blade

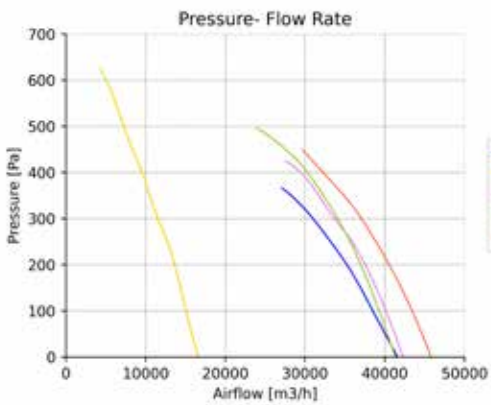

Ø800 / 6 Blade

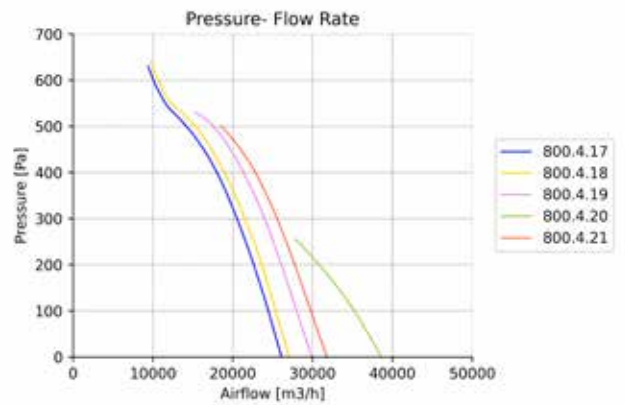

Ø900 / 6 Blade

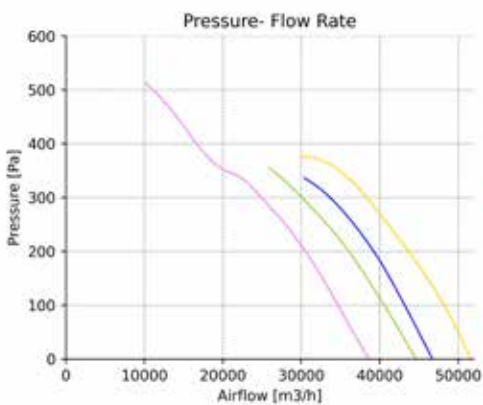

Ø900 / 8 Blade

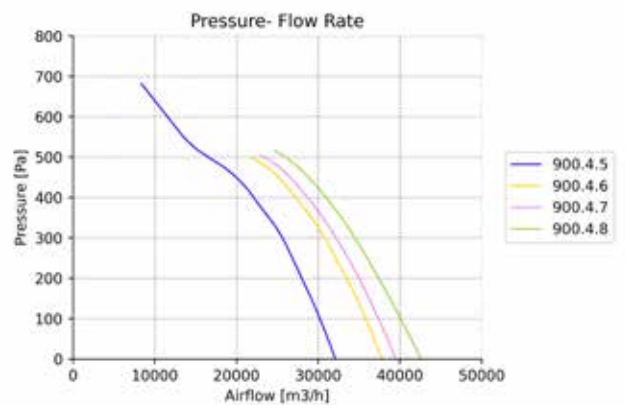

OWL CWA - SYSTEM CURVE - 4 POLES

Ø900 / 9 Blade

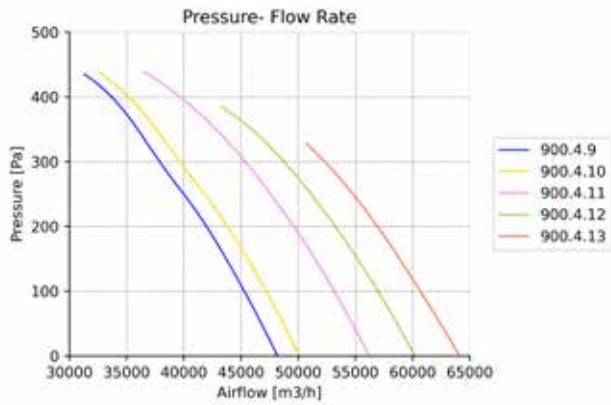

Ø900 / 12 Blade

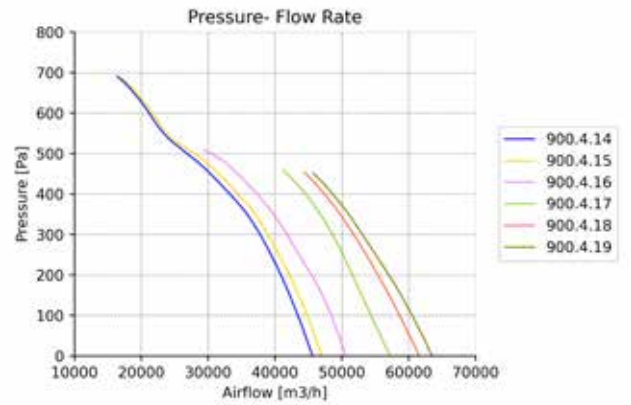

Ø900 / 6 Blade

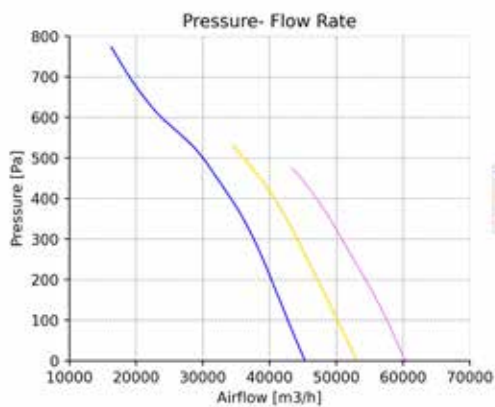

Ø1000 / 3 Blade

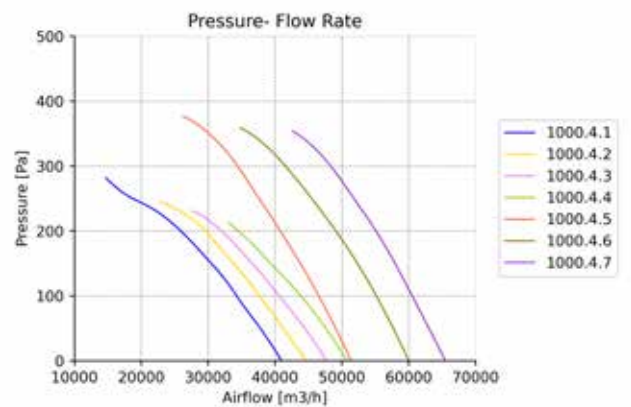

Ø1000 / 5-6 Blade

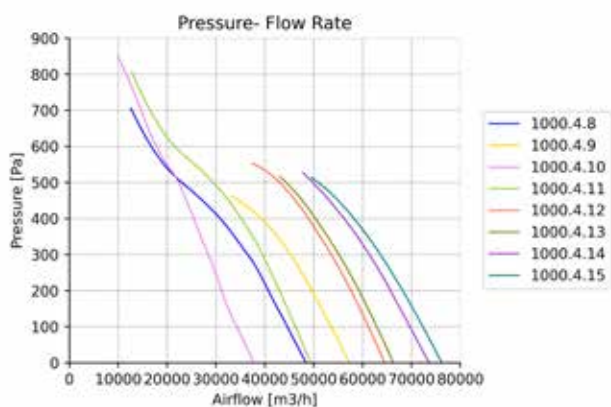

Ø1000 / 6 Blade

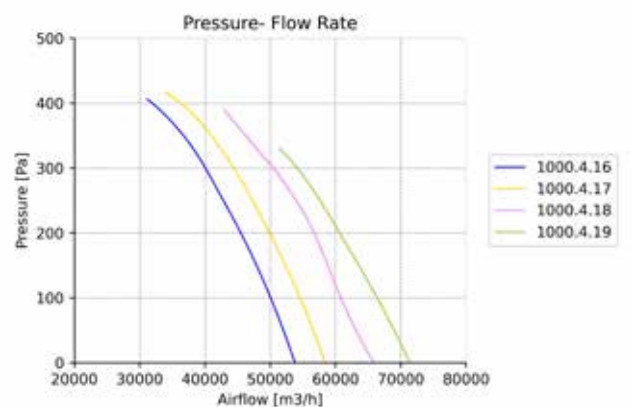

OWL CWA - SYSTEM CURVE - 4 POLES

Ø1000 / 6 Blade

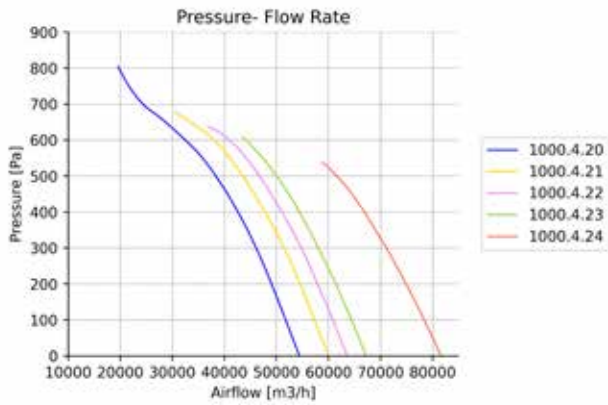

Ø1000 / 8 Blade

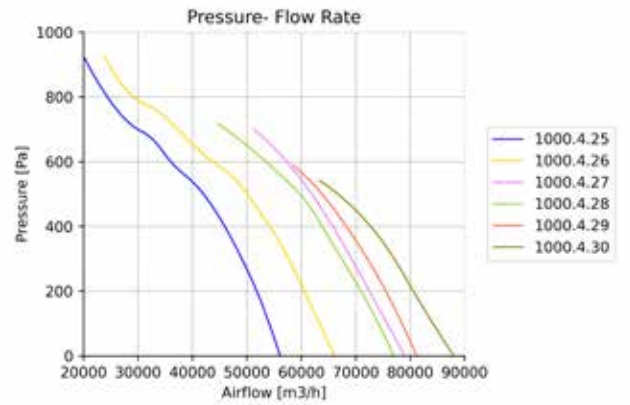

Ø1000 / 9 Blade

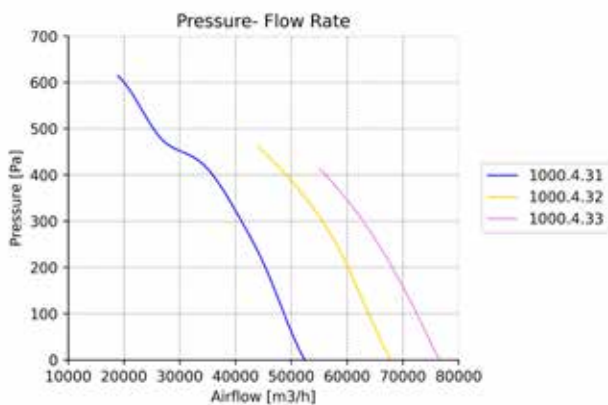

Ø1000 / 10 Blade

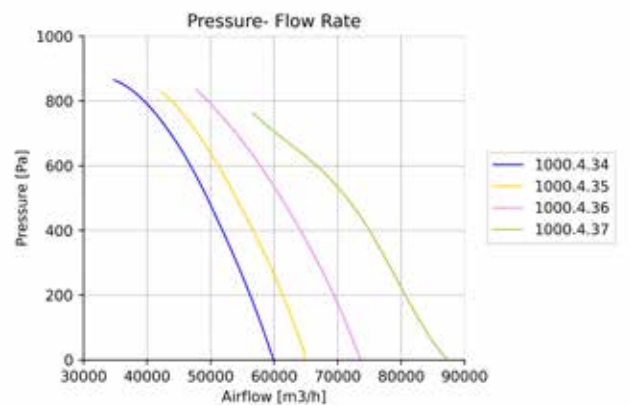

Ø1120 / 3 Blade

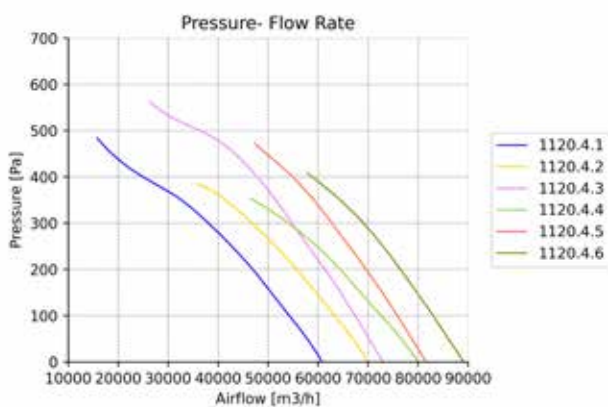

Ø1120 / 6 Blade

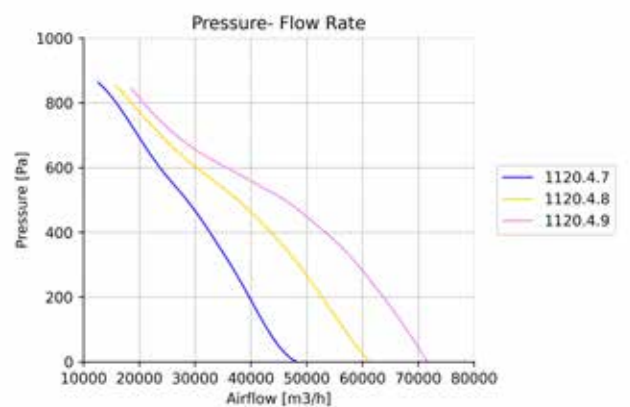

OWL CWA - SYSTEM CURVE - 4 POLES

Ø1120 / 6 Blade

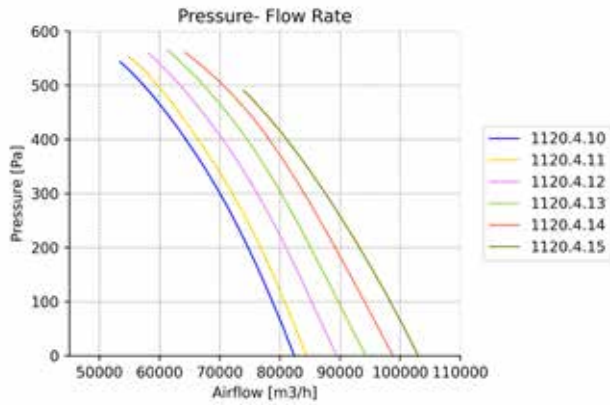

Ø1120 / 6 Blade

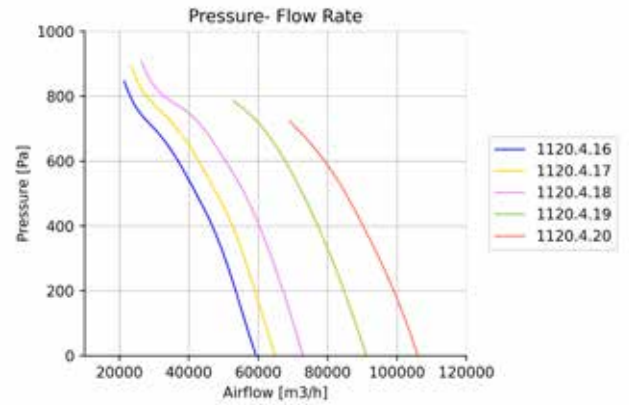

Ø1120 / 8 Blade

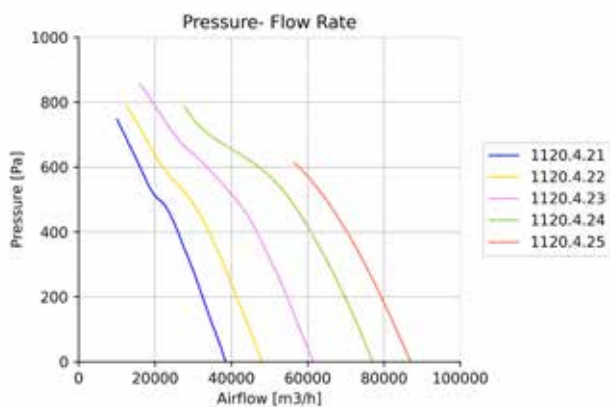

Ø1120 / 8 Blade

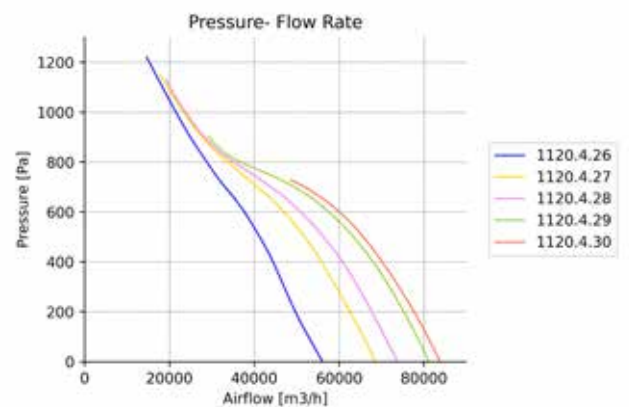

Ø1120 / 8 Blade

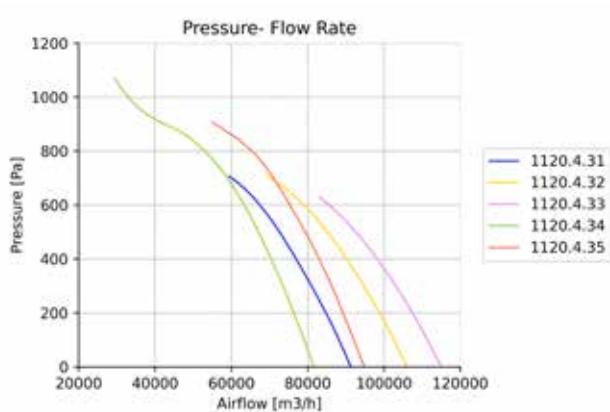

Ø1120 / 10-12 Blade

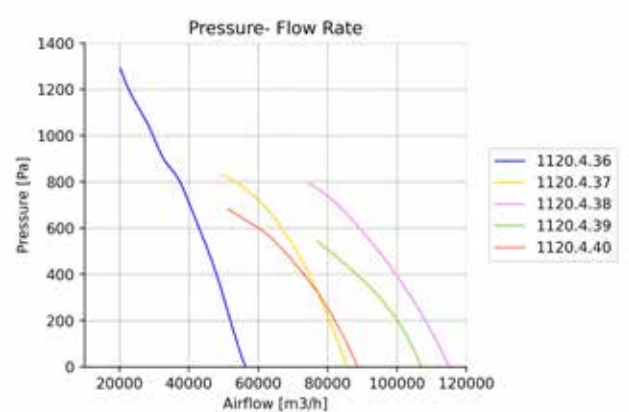

OWL CWA - SYSTEM CURVE - 4 POLES

Ø1250 / 3 Blade

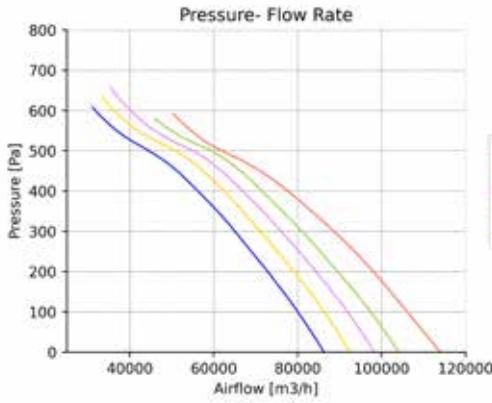

Ø1250 / 6 Blade

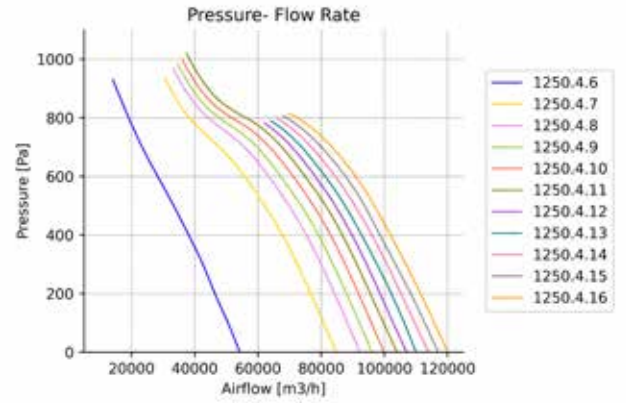

Ø1250 / 6 Blade

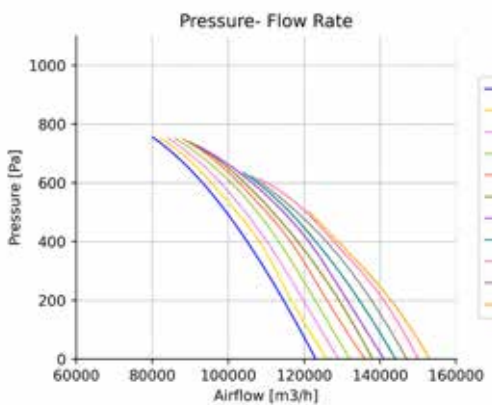

Ø1250 / 8 Blade

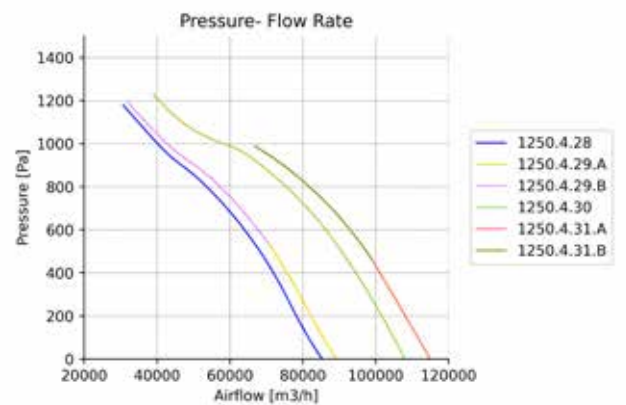

Ø1250 / 8 Blade

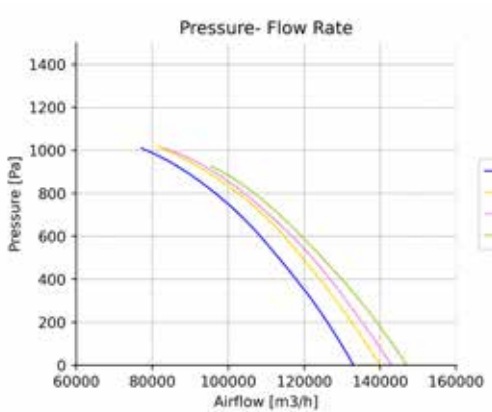

Ø1250 / 5 Blade

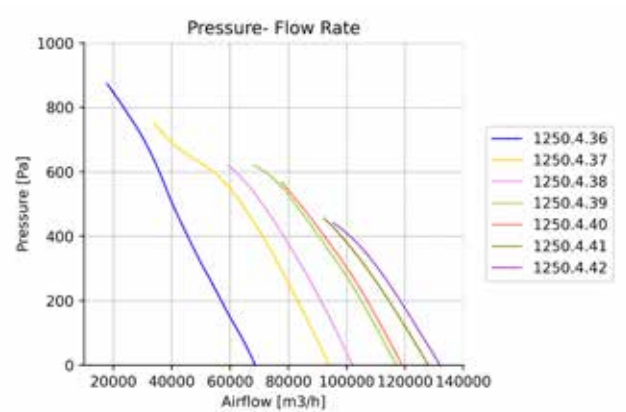

PRODUCT DIMENSIONS

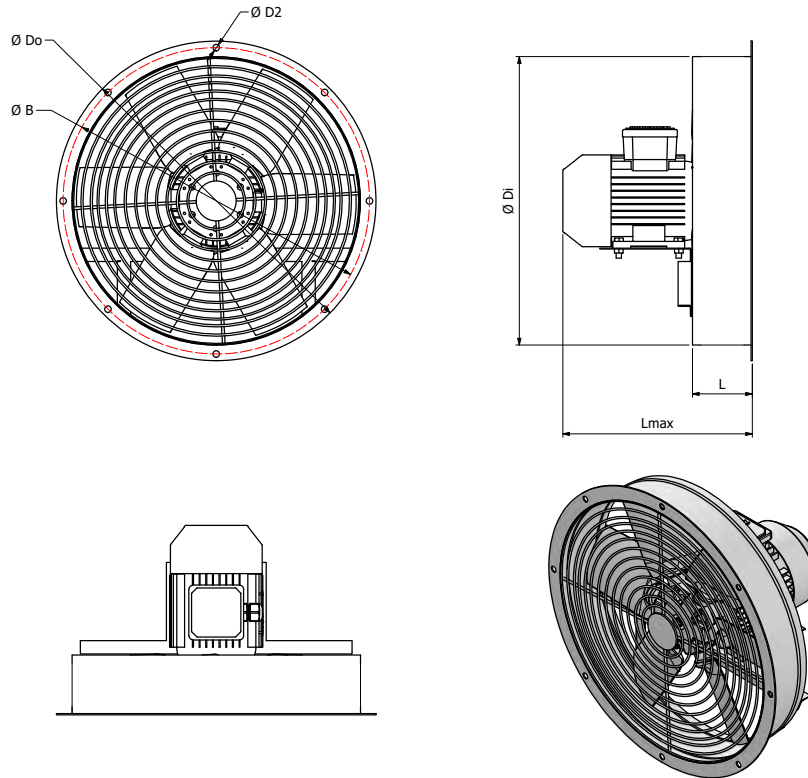

MODEL	$\varnothing d_i$	$\varnothing D_o$	kW	L	L2	$\varnothing B$	z x $\varnothing D_2$
OWL CWA 315	315	395	0,75	390	250	355	8 x 10
OWL CWA 355	355	435	0,75	390	250	395	8 x 10
OWL CWA 355	355	455	0,75	390	250	395	8 x 10
OWL CWA 355	355	455	1,1	445	250	395	8 x 10
OWL CWA 355	355	455	1,5	445	250	395	8 x 10
OWL CWA 400	400	480	0,75	390	250	450	8 x 12
OWL CWA 400	400	500	1,1	445	250	410	8 x 12
OWL CWA 400	400	500	1,1	445	250	410	8 x 12
OWL CWA 400	400	500	1,5	445	250	410	8 x 12
OWL CWA 400	400	500	2,2	520	250	410	8 x 12
OWL CWA 400	400	500	3	520	250	410	8 x 12
OWL CWA 450	450	530	1,1	445	250	500	8 x 12
OWL CWA 450	450	550	1,5	445	250	460	8 x 12
OWL CWA 450	450	550	2,2	520	250	460	8 x 12
OWL CWA 450	450	550	2,2	520	250	460	8 x 12
OWL CWA 450	450	550	3	520	250	460	8 x 12
OWL CWA 450	450	550	4	530	250	460	8 x 12
OWL CWA 450	450	550	5,5	570	250	460	8 x 12
OWL CWA 500	500	590	0,75	390	250	560	12 x 12
OWL CWA 500	500	640	1,1	445	250	550	12 x 12

MODEL	Ødi	ØDo	kW	L	L2	ØB	z x ØD2
OWL CWA 500	500	600	2,2	520	250	510	12 x 12
OWL CWA 500	500	600	2,2	520	250	510	12 x 12
OWL CWA 500	500	600	3	520	250	510	12 x 12
OWL CWA 500	500	600	4	530	250	510	12 x 12
OWL CWA 500	500	600	5,5	570	250	510	12 x 12
OWL CWA 500	500	600	7,5	610	250	510	12 x 12
OWL CWA 560	560	650	0,75	390	250	620	12 x 12
OWL CWA 560	560	700	0,75	390	250	620	12 x 12
OWL CWA 560	560	700	1,1	445	250	620	12 x 12
OWL CWA 560	560	700	1,1	445	250	620	12 x 12
OWL CWA 560	560	700	1,5	445	250	620	12 x 12
OWL CWA 560	560	700	2,2	520	250	620	12 x 12
OWL CWA 560	560	700	3	520	250	620	12 x 12
OWL CWA 560	560	700	4	530	250	620	12 x 12
OWL CWA 560	560	700	5,5	570	250	620	12 x 12
OWL CWA 560	560	700	7,5	610	250	620	12 x 12
OWL CWA 560	560	700	7,5	610	250	620	12 x 12
OWL CWA 560	560	700	11	710	250	620	12 x 12
OWL CWA 630	630	720	1,1	445	250	690	12 x 12
OWL CWA 630	630	770	1,5	445	250	690	12 x 12
OWL CWA 630	630	770	1,5	445	250	690	12 x 12
OWL CWA 630	630	770	1,5	445	250	690	12 x 12
OWL CWA 630	630	770	2,2	520	250	690	12 x 12
OWL CWA 630	630	770	2,2	520	250	690	12 x 12
OWL CWA 630	630	770	3	520	250	690	12 x 12
OWL CWA 630	630	770	4	530	250	690	12 x 12
OWL CWA 630	630	770	5,5	570	250	690	12 x 12
OWL CWA 630	630	770	7,5	610	250	690	12 x 12
OWL CWA 630	630	770	11	710	250	690	12 x 12
OWL CWA 630	630	770	11	710	250	690	12 x 12
OWL CWA 630	630	770	11	710	250	690	12 x 12
OWL CWA 630	630	770	15	710	250	690	12 x 12
OWL CWA 710	710	800	1,5	445	300	770	16 x 12
OWL CWA 710	710	850	2,2	520	300	770	16 x 12
OWL CWA 710	710	850	3	520	300	770	16 x 12
OWL CWA 710	710	850	3	520	300	770	16 x 12
OWL CWA 710	710	850	4	530	300	770	16 x 12
OWL CWA 710	710	850	7,5	610	300	770	16 x 12
OWL CWA 710	710	850	11	710	300	770	16 x 12
OWL CWA 710	710	850	11	710	300	770	16 x 12
OWL CWA 710	710	850	15	710	300	770	16 x 12
OWL CWA 710	710	850	18,5	770	300	770	16 x 12
OWL CWA 800	800	890	2,2	520	350	860	16 x 12
OWL CWA 800	800	940	3	520	350	860	16 x 12

MODEL	Ødi	ØDo	kW	L	L2	ØB	z x ØD2
OWL CWA 800	800	940	3	520	350	860	16 x 12
OWL CWA 800	800	940	4	530	350	860	16 x 12
OWL CWA 800	800	940	4	530	350	860	16 x 12
OWL CWA 800	800	940	5,5	570	350	860	16 x 12
OWL CWA 800	800	940	5,5	570	350	860	16 x 12
OWL CWA 800	800	940	7,5	610	350	860	16 x 12
OWL CWA 800	800	940	11	710	350	860	16 x 12
OWL CWA 900	900	1005	4	530	350	970	16 x 15
OWL CWA 900	900	1040	4	530	350	970	16 x 15
OWL CWA 900	900	1040	5,5	570	350	970	16 x 15
OWL CWA 900	900	1040	5,5	570	350	970	16 x 15
OWL CWA 900	900	1040	7,5	610	350	970	16 x 15
OWL CWA 900	900	1040	7,5	610	350	970	16 x 15
OWL CWA 900	900	1040	7,5	610	350	970	16 x 15
OWL CWA 900	900	1040	11	710	350	970	16 x 15
OWL CWA 900	900	1040	11	710	350	970	16 x 15
OWL CWA 900	900	1040	15	710	350	970	16 x 15
OWL CWA 1000	1000	1105	5,5	570	400	1070	16 x 15
OWL CWA 1000	1000	1160	7,5	610	400	1080	16 x 15
OWL CWA 1000	1000	1160	11	710	400	1080	16 x 15
OWL CWA 1000	1000	1160	11	710	400	1080	16 x 15
OWL CWA 1000	1000	1160	11	710	400	1080	16 x 15
OWL CWA 1000	1000	1160	15	710	400	1080	16 x 15
OWL CWA 1000	1000	1160	15	710	400	1080	16 x 15
OWL CWA 1000	1000	1160	18,5	770	400	1080	16 x 15
OWL CWA 1000	1000	1160	18,5	770	400	1080	16 x 15
OWL CWA 1000	1000	1160	22	770	400	1080	16 x 15
OWL CWA 1000	1000	1160	30	860	400	1080	16 x 15
OWL CWA 1120	1120	1260	11	710	400	1190	20 x 15
OWL CWA 1120	1120	1280	15	710	400	1200	20 x 15
OWL CWA 1120	1120	1280	18,5	770	400	1200	20 x 15
OWL CWA 1120	1120	1280	22	770	400	1200	20 x 15
OWL CWA 1120	1120	1280	30	860	400	1200	20 x 15
OWL CWA 1120	1120	1280	37	930	400	1200	20 x 15
OWL CWA 1250	1250	1390	15	710	400	1320	20 x 15
OWL CWA 1250	1250	1410	18,5	770	400	1330	20 x 15
OWL CWA 1250	1250	1410	22	770	400	1330	20 x 15
OWL CWA 1250	1250	1410	30	860	400	1330	20 x 15
OWL CWA 1250	1250	1410	37	930	400	1330	20 x 15
OWL CWA 1250	1250	1410	45	930	400	1330	20 x 15
OWL CWA 1250	1250	1410	55	1010	400	1330	20 x 15

TECHNICAL PARAMETERS

MODEL	MODEL NUMBER	Voltage Frequency	Motor Power	Current	Rotation Speed	Sound Pressure	Protection Class	Working Range	Mass
		V-Hz	kW	A	RPM	Lp(A) dB at 3m	IP	°C	~ Kg
OWL CWA 315P1U-2T0,37	315.1	400-50	0,37	1,5	2880	60,1	55	-20/+50	15
OWL CWA 315P2U-2T0,37	315.2	400-50	0,37	1,5	2880	63,3	55	-20/+50	15
OWL CWA 315P3U-2T0,37	315.3	400-50	0,37	1,5	2880	63	55	-20/+50	15
OWL CWA 315P4U-2T0,37	315.4	400-50	0,37	1,5	2880	65	55	-20/+50	15
OWL CWA 315P5U-2T0,55	315.5	400-50	0,55	1,6	2880	66,3	55	-20/+50	16
OWL CWA 315P6U-2T0,55	315.6	400-50	0,55	1,6	2880	66,3	55	-20/+50	16
OWL CWA 315P7U-2T0,37	315.7	400-50	0,37	1,5	2880	65,1	55	-20/+50	15
OWL CWA 315P8U-2T0,37	315.8	400-50	0,37	1,5	2880	66,1	55	-20/+50	15
OWL CWA 315P9U-2T0,55	315.9	400-50	0,55	1,6	2880	62,1	55	-20/+50	16
OWL CWA 315P10U-2T0,55	315.10	400-50	0,55	1,6	2880	62,6	55	-20/+50	16
OWL CWA 315P11U-2T0,75	315.11	400-50	0,75	1,7	2880	63,9	55	-20/+50	18
OWL CWA 315P12U-2T1,1	315.12	400-50	1,1	2,3	2880	65,1	55	-20/+50	19
OWL CWA 355P1U-2T0,37	355.1	400-50	0,37	1,5	2880	61,1	55	-20/+50	16
OWL CWA 355P2U-2T0,37	355.2	400-50	0,37	1,5	2880	59,2	55	-20/+50	16
OWL CWA 355P3U-2T0,55	355.3	400-50	0,55	1,6	2880	61,9	55	-20/+50	17
OWL CWA 355P4U-2T0,55	355.4	400-50	0,55	1,6	2880	63,2	55	-20/+50	17
OWL CWA 355P5U-2T0,75	355.5	400-50	0,75	1,7	2880	65,1	55	-20/+50	19
OWL CWA 355P6U-2T0,55	355.6	400-50	0,55	1,6	2880	63,6	55	-20/+50	18
OWL CWA 355P7U-2T0,55	355.7	400-50	0,55	1,6	2880	66,9	55	-20/+50	18
OWL CWA 355P8U-2T0,75	355.8	400-50	0,75	1,7	2880	62,5	55	-20/+50	20
OWL CWA 355P9U-2T0,75	355.9	400-50	0,75	1,7	2880	63,1	55	-20/+50	19
OWL CWA 355P10U-2T1,1	355.10	400-50	1,1	2,3	2880	63,4	55	-20/+50	20
OWL CWA 355P11U-2T0,75	355.11	400-50	0,75	1,7	2880	64,2	55	-20/+50	19
OWL CWA 355P12U-2T1,5	355.12	400-50	1,5	3,3	2880	66,8	55	-20/+50	23
OWL CWA 400P1U-2T0,37	400.1	400-50	0,37	1,5	2880	65,5	55	-20/+50	17
OWL CWA 400P2U-2T0,55	400.2	400-50	0,55	1,6	2880	63,5	55	-20/+50	18
OWL CWA 400P3U-2T0,75	400.3	400-50	0,75	1,7	2880	64,8	55	-20/+50	20
OWL CWA 400P4U-2T0,75	400.4	400-50	0,75	1,7	2880	65,6	55	-20/+50	20
OWL CWA 400P5U-2T1,1	400.5	400-50	1,1	2,3	2880	68,2	55	-20/+50	22
OWL CWA 400P6U-2T1,1	400.6	400-50	1,1	2,3	2880	65,5	55	-20/+50	23
OWL CWA 400P7U-2T1,5	400.7	400-50	1,5	3,3	2880	68	55	-20/+50	25
OWL CWA 400P8U-2T2,2	400.8	400-50	2,2	4,5	2880	70,4	55	-20/+50	28
OWL CWA 400P9U-2T0,75	400.9	400-50	0,75	1,7	2880	68,6	55	-20/+50	20
OWL CWA 400P10U-2T0,75	400.10	400-50	0,75	1,7	2880	66,6	55	-20/+50	20
OWL CWA 400P11U-2T1,1	400.11	400-50	1,1	2,3	2880	65,2	55	-20/+50	23
OWL CWA 400P12U-2T1,5	400.12	400-50	1,5	3,3	2880	66,4	55	-20/+50	25
OWL CWA 400P13U-2T1,5	400.13	400-50	1,5	3,3	2880	66,2	55	-20/+50	25
OWL CWA 400P14U-2T2,2	400.14	400-50	2,2	4,5	2880	66,5	55	-20/+50	28
OWL CWA 400P15U-2T3	400.15	400-50	3	5,9	2880	69,3	55	-20/+50	36

MODEL	MODEL NUMBER	Voltage Frequency	Motor Power	Current	Rotation Speed	Sound Pressure	Protection Class	Working Range	Mass
		V-Hz	kW	A	RPM	Lp(A) dB at 3m	IP	°C	~ Kg
OWL CWA 450P1U-2T0,55	450.1	400-50	0,55	1,6	2880	69	55	-20/+50	20
OWL CWA 450P2U-2T0,75	450.2	400-50	0,75	1,7	2880	72,9	55	-20/+50	22
OWL CWA 450P3U-2T1,1	450.3	400-50	1,1	2,3	2880	67,9	55	-20/+50	25
OWL CWA 450P4U-2T1,1	450.4	400-50	1,1	2,3	2880	69,3	55	-20/+50	24
OWL CWA 450P5U-2T1,1	450.5	400-50	1,1	2,3	2880	73	55	-20/+50	25
OWL CWA 450P6U-2T1,5	450.6	400-50	1,5	3,3	2880	67,3	55	-20/+50	27
OWL CWA 450P7U-2T2,2	450.7	400-50	2,2	4,5	2880	70,4	55	-20/+50	30
OWL CWA 450P8U-2T1,5	450.8	400-50	1,5	3,3	2880	72,3	55	-20/+50	28
OWL CWA 450P9U-2T2,2	450.9	400-50	2,2	4,5	2880	70,6	55	-20/+50	30
OWL CWA 450P10U-2T2,2	450.10	400-50	2,2	4,5	2880	69,9	55	-20/+50	30
OWL CWA 450P11U-2T3	450.11	400-50	3	5,9	2880	71	55	-20/+50	37
OWL CWA 450P12U-2T4	450.12	400-50	4	7,9	2880	74,2	55	-20/+50	39
OWL CWA 450P13U-2T3	450.13	400-50	3	5,9	2880	69,4	55	-20/+50	38
OWL CWA 450P14U-2T3	450.14	400-50	3	5,9	2880	69,4	55	-20/+50	38
OWL CWA 450P15U-2T5,5	450.15	400-50	5,5	10,3	2880	70,7	55	-20/+50	55
OWL CWA 500P1U-2T0,75	500.1	400-50	0,75	1,7	2880	76,3	55	-20/+50	29
OWL CWA 500P2U-2T1,1	500.2	400-50	1,1	2,3	2880	70,8	55	-20/+50	33
OWL CWA 500P3U-2T1,5	500.3	400-50	1,5	3,3	2880	72,2	55	-20/+50	36
OWL CWA 500P4U-2T2,2	500.4	400-50	2,2	4,5	2880	70,4	55	-20/+50	38
OWL CWA 500P5U-2T2,2	500.5	400-50	2,2	4,5	2880	69,9	55	-20/+50	38
OWL CWA 500P6U-2T2,2	500.6	400-50	2,2	4,5	2880	66,8	55	-20/+50	39
OWL CWA 500P7U-2T3	500.7	400-50	3	5,9	2880	70,4	55	-20/+50	46
OWL CWA 500P8U-2T3	500.8	400-50	3	5,9	2880	74	55	-20/+50	46
OWL CWA 500P9U-2T4	500.9	400-50	4	7,9	2880	74,5	55	-20/+50	48
OWL CWA 500P10U-2T4	500.10	400-50	4	7,9	2880	72,2	55	-20/+50	48
OWL CWA 500P11U-2T5,5	500.11	400-50	5,5	10,3	2880	71,9	55	-20/+50	64
OWL CWA 500P12U-2T7,5	500.12	400-50	7,5	13,6	2880	72,7	55	-20/+50	71
OWL CWA 500P13U-2T7,5	500.13	400-50	7,5	13,6	2880	72,7	55	-20/+50	71
OWL CWA 560P1U-2T0,75	560.1	400-50	0,75	1,7	2880	72,7	55	-20/+50	34
OWL CWA 560P2U-2T1,1	560.2	400-50	1,1	2,3	2880	70,4	55	-20/+50	35
OWL CWA 560P3U-2T1,5	560.3	400-50	1,5	3,3	2880	73,7	55	-20/+50	38
OWL CWA 560P4U-2T2,2	560.4	400-50	3	5,9	2880	74	55	-20/+50	41
OWL CWA 560P5U-2T4	560.5	400-50	4	7,9	2880	72,7	55	-20/+50	50
OWL CWA 560P6U-2T4	560.6	400-50	4	7,9	2880	73,8	55	-20/+50	50
OWL CWA 560P7U-2T5,5	560.7	400-50	5,5	10,3	2880	75,6	55	-20/+50	66
OWL CWA 560P8U-2T3	560.8	400-50	3	5,9	2880	72,7	55	-20/+50	48
OWL CWA 560P9U-2T4	560.9	400-50	4	7,9	2880	73,2	55	-20/+50	50
OWL CWA 560P10U-2T5,5	560.10	400-50	5,5	10,3	2880	73,5	55	-20/+50	66
OWL CWA 560P11U-2T7,5	560.11	400-50	7,5	13,6	2880	75,3	55	-20/+50	73

MODEL	MODEL NUMBER	Voltage Frequency	Motor Power	Current	Rotation Speed	Sound Pressure	Protection Class	Working Range	Mass
		V-Hz	kW	A	RPM	Lp(A) dB at 3m	IP	°C	~ Kg
OWL CWA 560P12U-2T4	560.12	400-50	4	7,9	2880	74,3	55	-20/+50	50
OWL CWA 560P13U-2T5,5	560.13	400-50	5,5	10,3	2880	75,7	55	-20/+50	66
OWL CWA 560P14U-2T7,5	560.14	400-50	7,5	13,6	2880	74,4	55	-20/+50	73
OWL CWA 560P15U-2T11	560.15	400-50	11	19,5	2880	75,1	55	-20/+50	99
OWL CWA 560P16U-2T11	560.16	400-50	11	19,5	2880	74,8	55	-20/+50	99
OWL CWA 630P1U-2T2,2	630.1	400-50	2,2	4,5	2880	73,7	55	-20/+50	43
OWL CWA 630P2U-2T3	630.2	400-50	3	5,9	2880	74,8	55	-20/+50	51
OWL CWA 630P3U-2T5,5	630.3	400-50	5,5	10,3	2880	73,2	55	-20/+50	68
OWL CWA 630P4U-2T5,5	630.4	400-50	5,5	10,3	2880	75,3	55	-20/+50	68
OWL CWA 630P5U-2T7,5	630.5	400-50	7,5	13,6	2880	78,5	55	-20/+50	76
OWL CWA 630P6U-2T7,5	630.6	400-50	7,5	13,6	2880	76,4	55	-20/+50	75
OWL CWA 630P7U-2T11	630.7	400-50	11	19,5	2880	78,7	55	-20/+50	102
OWL CWA 630P8U-2T11	630.8	400-50	11	19,5	2880	76,7	55	-20/+50	102
OWL CWA 630P9U-2T7,5	630.9	400-50	7,5	13,6	2880	78,4	55	-20/+50	76
OWL CWA 630P10U-2T11	630.10	400-50	11	19,5	2880	76,6	55	-20/+50	102
OWL CWA 630P11U-2T11	630.11	400-50	11	19,5	2880	76,7	55	-20/+50	103
OWL CWA 630P12U-2T15	630.12	400-50	15	28,3	2880	76,6	55	-20/+50	116
OWL CWA 630P13U-2T15	630.13	400-50	15	28,3	2880	78,7	55	-20/+50	116
OWL CWA 630P14U-2T15	630.14	400-50	15	28,3	2880	76,5	55	-20/+50	116
OWL CWA 710P1U-2T3	710.1	400-50	3	5,9	2880	79,8	55	-20/+50	55
OWL CWA 710P2U-2T5,5	710.2	400-50	5,5	10,3	2880	77	55	-20/+50	73
OWL CWA 710P3U-2T7,5	710.3	400-50	7,5	13,6	2880	77,3	55	-20/+50	80
OWL CWA 710P4U-2T7,5	710.4	400-50	7,5	13,6	2880	78,1	55	-20/+50	80
OWL CWA 710P5U-2T11	710.5	400-50	11	19,5	2880	78,9	55	-20/+50	111
OWL CWA 710P6U-2T11	710.6	400-50	11	19,5	2880	79,9	55	-20/+50	111
OWL CWA 710P7U-2T5,5	710.7	400-50	5,5	10,3	2880	87,5	55	-20/+50	73
OWL CWA 710P8.AU-2T7,5	710.8.A	400-50	7,5	13,6	2880	83,5	55	-20/+50	80
OWL CWA 710P8.BU-2T11	710.8.B	400-50	11	19,5	2880	83,5	55	-20/+50	111
OWL CWA 710P9U-2T15	710.9	400-50	15	28,3	2880	76,4	55	-20/+50	126
OWL CWA 710P10U-2T11	710.10	400-50	11	19,5	2880	81,5	55	-20/+50	111
OWL CWA 710P11U-2T15	710.11	400-50	15	28,3	2880	78,3	55	-20/+50	127
OWL CWA 710P12U-2T15	710.12	400-50	15	28,3	2880	81,5	55	-20/+50	125
OWL CWA 710P13U-2T18,5	710.13	400-50	18,5	32,3	2880	82,5	55	-20/+50	147
OWL CWA 710P14U-2T18,5	710.14	400-50	18,5	32,3	2880	82,5	55	-20/+50	147
OWL CWA 800P1U-2T11	800.1	400-50	11	19,5	2880	82,5	55	-20/+50	121
OWL CWA 800P2U-2T15	800.2	400-50	15	28,3	2880	83,5	55	-20/+50	135
OWL CWA 800P3U-2T18,5	800.3	400-50	18,5	32,3	2880	85,5	55	-20/+50	157
OWL CWA 800P4U-2T22	800.4	400-50	22	38,3	2880	86,5	55	-20/+50	189
OWL CWA 800P5U-2T18,5	800.5	400-50	18,5	32,3	2880	86,5	55	-20/+50	152
OWL CWA 800P6U-2T18,5	800.6	400-50	18,5	32,3	2880	86,5	55	-20/+50	152
OWL CWA 800P7U-2T22	800.7	400-50	22	38,3	2880	86,5	55	-20/+50	184

MODEL	MODEL NUMBER	Voltage Frequency	Motor Power	Current	Rotation Speed	Sound Pressure	Protection Class	Working Range	Mass
		V-Hz	kW	A	RPM	Lp(A) dB at 3m	IP	°C	~ Kg
OWL CWA 315P1U-4T0,37	315.1	400-50	0,37	1,13	1440	50,1	55	-20/+50	17
OWL CWA 315P2U-4T0,37	315.2	400-50	0,37	1,13	1440	50,2	55	-20/+50	18
OWL CWA 355P1U-4T0,37	355.1	400-50	0,37	1,13	1440	47,5	55	-20/+50	19
OWL CWA 355P2U-4T0,37	355.2	400-50	0,37	1,13	1440	49,1	55	-20/+50	19
OWL CWA 400P1U-4T0,37	400.1	400-50	0,37	1,13	1440	51,5	55	-20/+50	20
OWL CWA 400P2U-4T0,37	400.2	400-50	0,37	1,13	1440	51,7	55	-20/+50	20
OWL CWA 400P3U-4T0,37	400.3	400-50	0,37	1,13	1440	52,6	55	-20/+50	20
OWL CWA 450P1U-4T0,37	450.1	400-50	0,37	1,13	1440	53,7	55	-20/+50	22
OWL CWA 450P2U-4T0,37	450.2	400-50	0,37	1,13	1440	55,6	55	-20/+50	23
OWL CWA 450P3U-4T0,37	450.3	400-50	0,37	1,13	1440	55,7	55	-20/+50	22
OWL CWA 450P4U-4T0,55	450.4	400-50	0,55	1,55	1440	54,4	55	-20/+50	23
OWL CWA 450P5U-4T0,37	450.5	400-50	0,37	1,13	1440	54,4	55	-20/+50	23
OWL CWA 450P6U-4T0,55	450.6	400-50	0,55	1,55	1440	54,4	55	-20/+50	23
OWL CWA 450P7U-4T0,75	450.7	400-50	0,75	2	1440	54,5	55	-20/+50	27
OWL CWA 500P1U-4T0,37	500.1	400-50	0,37	1,13	1440	52,7	55	-20/+50	31
OWL CWA 500P2U-4T0,55	500.2	400-50	0,55	1,55	1440	57,5	55	-20/+50	31
OWL CWA 500P3U-4T0,37	500.3	400-50	0,37	1,13	1440	58,6	55	-20/+50	31
OWL CWA 500P4U-4T0,75	500.4	400-50	0,75	2	1440	57,8	55	-20/+50	35
OWL CWA 500P5U-4T0,55	500.5	400-50	0,55	1,55	1440	58,8	55	-20/+50	32
OWL CWA 500P6U-4T0,75	500.6	400-50	0,75	2	1440	58,8	55	-20/+50	36
OWL CWA 500P7U-4T1,1	500.7	400-50	1,1	2,6	1440	59,5	55	-20/+50	41
OWL CWA 560P1U-4T0,37	560.1	400-50	0,37	1,13	1440	59,6	55	-20/+50	36
OWL CWA 560P2U-4T0,55	560.2	400-50	0,55	1,55	1440	59,2	55	-20/+50	36
OWL CWA 560P3U-4T0,75	560.3	400-50	0,75	2	1440	60,5	55	-20/+50	40
OWL CWA 560P4U-4T0,75	560.4	400-50	0,75	2	1440	61	55	-20/+50	40
OWL CWA 560P5U-4T1,1	560.5	400-50	1,1	2,6	1440	60,7	55	-20/+50	43
OWL CWA 560P6U-4T0,37	560.6	400-50	0,37	1,13	1440	61,3	55	-20/+50	37
OWL CWA 560P7U-4T0,75	560.7	400-50	0,75	2	1440	60,8	55	-20/+50	41
OWL CWA 560P8U-4T1,1	560.8	400-50	1,1	2,6	1440	59,8	55	-20/+50	44
OWL CWA 560P9U-4T1,1	560.9	400-50	1,1	2,6	1440	60,3	55	-20/+50	43
OWL CWA 560P10U-4T1,5	560.10	400-50	1,5	3,5	1440	61,2	55	-20/+50	47
OWL CWA 630P1U-4T0,55	630.1	400-50	0,55	1,55	1440	61,4	55	-20/+50	40
OWL CWA 630P2U-4T0,55	630.2	400-50	0,55	1,55	1440	61	55	-20/+50	40
OWL CWA 630P3U-4T0,75	630.3	400-50	0,75	2	1440	59,2	55	-20/+50	44
OWL CWA 630P4U-4T1,1	630.4	400-50	1,1	2,6	1440	62,6	55	-20/+50	46
OWL CWA 630P5U-4T1,5	630.5	400-50	1,5	3,5	1440	63,4	55	-20/+50	49
OWL CWA 630P6U-4T0,75	630.6	400-50	0,75	2	1440	62,2	55	-20/+50	44
OWL CWA 630P7U-4T2,2	630.7	400-50	2,2	5	1440	66,1	55	-20/+50	51
OWL CWA 630P8U-4T0,75	630.8	400-50	0,75	2	1440	62,8	55	-20/+50	44
OWL CWA 630P9U-4T0,75	630.9	400-50	0,75	2	1440	68	55	-20/+50	44
OWL CWA 630P10U-4T1,1	630.10	400-50	1,1	2,6	1440	61,5	55	-20/+50	46
OWL CWA 630P11U-4T1,5	630.11	400-50	1,5	3,5	1440	61,4	55	-20/+50	50
OWL CWA 630P12U-4T1,5	630.12	400-50	1,5	3,5	1440	62	55	-20/+50	49
OWL CWA 630P13U-4T2,2	630.13	400-50	2,2	5	1440	63	55	-20/+50	51
OWL CWA 630P14U-4T2,2	630.14	400-50	2,2	5	1440	63,1	55	-20/+50	52
OWL CWA 630P15U-4T1,5	630.15	400-50	1,5	3,5	1440	66,3	55	-20/+50	50

MODEL	MODEL NUMBER	Voltage Frequency	Motor Power	Current	Rotation Speed	Sound Pressure	Protection Class	Working Range	Mass
		V-Hz	kW	A	RPM	Lp(A) dB at 3m	IP	°C	~ Kg
OWL CWA 630P16U-4T2,2	630.16	400-50	2,2	5	1440	66,2	55	-20/+50	52
OWL CWA 630P17U-4T2,2	630.17	400-50	2,2	5	1440	66,1	55	-20/+50	52
OWL CWA 630P18U-4T2,2	630.18	400-50	2,2	5	1440	66,4	55	-20/+50	52
OWL CWA 630P19U-4T3	630.19	400-50	3	6,6	1440	67,8	55	-20/+50	59
OWL CWA 710P1U-4T0,75	710.1	400-50	0,75	2	1440	66,8	55	-20/+50	48
OWL CWA 710P2U-4T1,5	710.2	400-50	1,5	3,5	1440	64	55	-20/+50	53
OWL CWA 710P3U-4T1,5	710.3	400-50	1,5	3,5	1440	66,9	55	-20/+50	54
OWL CWA 710P4U-4T2,2	710.4	400-50	2,2	5	1440	67	55	-20/+50	56
OWL CWA 710P5U-4T3	710.5	400-50	3	6,6	1440	67,8	55	-20/+50	62
OWL CWA 710P6U-4T3	710.6	400-50	3	6,6	1440	68,5	55	-20/+50	62
OWL CWA 710P7U-4T3	710.7	400-50	3	6,6	1440	69,1	55	-20/+50	63
OWL CWA 710P8U-4T1,5	710.8	400-50	1,5	3,5	1440	64,8	55	-20/+50	56
OWL CWA 710P9U-4T2,2	710.9	400-50	2,2	5	1440	63,2	55	-20/+50	58
OWL CWA 710P10U-4T2,2	710.10	400-50	2,2	5	1440	68,8	55	-20/+50	57
OWL CWA 710P11U-4T3	710.11	400-50	3	6,6	1440	68	55	-20/+50	63
OWL CWA 710P12U-4T4	710.12	400-50	4	8,4	1440	68,5	55	-20/+50	72
OWL CWA 710P13U-4T4	710.13	400-50	4	8,4	1440	67,5	55	-20/+50	70
OWL CWA 710P14U-4T5,5	710.14	400-50	5,5	11,2	1440	68,5	55	-20/+50	81
OWL CWA 800P1U-4T2,2	800.1	400-50	2,2	5	1440	71,8	55	-20/+50	61
OWL CWA 800P2U-4T3	800.2	400-50	3	6,6	1440	70	55	-20/+50	67
OWL CWA 800P3U-4T3	800.3	400-50	3	6,6	1440	69,1	55	-20/+50	67
OWL CWA 800P4U-4T4	800.4	400-50	4	8,4	1440	70,1	55	-20/+50	78
OWL CWA 800P5U-4T4	800.5	400-50	4	8,4	1440	70,3	55	-20/+50	78
OWL CWA 800P6U-4T4	800.6	400-50	4	8,4	1440	69,6	55	-20/+50	78
OWL CWA 800P7U-4T5,5	800.7	400-50	5,5	11,2	1440	71,1	55	-20/+50	89
OWL CWA 800P8U-4T5,5	800.8	400-50	5,5	11,2	1440	71,8	55	-20/+50	89
OWL CWA 800P9U-4T1,5	800.9	400-50	1,5	3,5	1440	74,2	55	-20/+50	59
OWL CWA 800P10U-4T3	800.10	400-50	3	6,6	1440	73,1	55	-20/+50	68
OWL CWA 800P11U-4T4	800.11	400-50	4	8,4	1440	71,7	55	-20/+50	79
OWL CWA 800P12U-4T5,5	800.12	400-50	5,5	11,2	1440	70,7	55	-20/+50	90
OWL CWA 800P13U-4T7,5	800.13	400-50	7,5	15,4	1440	71,7	55	-20/+50	96
OWL CWA 800P14U-4T2,2	800.14	400-50	2,2	5	1440	73,3	55	-20/+50	62
OWL CWA 800P15U-4T11	800.15	400-50	11	21,3	1440	72,1	55	-20/+50	143
OWL CWA 800P16U-4T7,5	800.16	400-50	7,5	15,4	1440	71,9	55	-20/+50	98
OWL CWA 800P17U-4T11	800.17	400-50	11	21,3	1440	72,4	55	-20/+50	143
OWL CWA 800P18U-4T4	800.18	400-50	4	8,4	1440	72,8	55	-20/+50	85
OWL CWA 800P19U-4T4	800.19	400-50	4	8,4	1440	73	55	-20/+50	85
OWL CWA 800P20U-4T5,5	800.20	400-50	5,5	11,2	1440	72,5	55	-20/+50	96
OWL CWA 800P21U-4T5,5	800.21	400-50	5,5	11,2	1440	71,9	55	-20/+50	96
OWL CWA 900P1U-4T5,5	900.1	400-50	5,5	11,2	1440	77,7	55	-20/+50	96
OWL CWA 900P2U-4T7,5	900.2	400-50	7,5	15,4	1440	71,5	55	-20/+50	103
OWL CWA 900P3U-4T4	900.3	400-50	4	8,4	1440	71,3	55	-20/+50	86
OWL CWA 900P4U-4T5,5	900.4	400-50	5,5	11,2	1440	71,4	55	-20/+50	97
OWL CWA 900P5U-4T4	900.5	400-50	4	8,4	1440	74,9	55	-20/+50	86
OWL CWA 900P6U-4T5,5	900.6	400-50	5,5	11,2	1440	74,1	55	-20/+50	97
OWL CWA 900P7U-4T7,5	900.7	400-50	7,5	15,4	1440	74,2	55	-20/+50	104

MODEL	MODEL NUMBER	Voltage Frequency	Motor Power	Current	Rotation Speed	Sound Pressure	Protection Class	Working Range	Mass
		V-Hz	kW	A	RPM	Lp(A) dB at 3m	IP	°C	~ Kg
OWL CWA 900P8U-4T7,5	900.8	400-50	7,5	15,4	1440	72,7	55	-20/+50	104
OWL CWA 900P9U-4T7,5	900.9	400-50	7,5	15,4	1440	73,5	55	-20/+50	104
OWL CWA 900P10U-4T7,5	900.10	400-50	7,5	15,4	1440	74,2	55	-20/+50	104
OWL CWA 900P11U-4T11	900.11	400-50	11	21,3	1440	73,8	55	-20/+50	150
OWL CWA 900P12U-4T11	900.12	400-50	11	21,3	1440	73,9	55	-20/+50	150
OWL CWA 900P13U-4T15	900.13	400-50	15	29,8	1440	73	55	-20/+50	170
OWL CWA 900P14U-4T7,5	900.14	400-50	7,5	15,4	1440	74,1	55	-20/+50	105
OWL CWA 900P15U-4T7,5	900.15	400-50	7,5	15,4	1440	76,9	55	-20/+50	105
OWL CWA 900P16U-4T11	900.16	400-50	11	21,3	1440	78,8	55	-20/+50	151
OWL CWA 900P17U-4T15	900.17	400-50	15	29,8	1440	74,7	55	-20/+50	172
OWL CWA 900P18U-4T15	900.18	400-50	15	29,8	1440	74,5	55	-20/+50	172
OWL CWA 900P19U-4T15	900.19	400-50	15	29,8	1440	75,3	55	-20/+50	172
OWL CWA 900P20U-4T11	900.20	400-50	11	21,3	1440	74,4	55	-20/+50	156
OWL CWA 900P21U-4T11	900.21	400-50	11	21,3	1440	74,4	55	-20/+50	156
OWL CWA 900P22U-4T15	900.22	400-50	15	29,8	1440	72,6	55	-20/+50	176
OWL CWA 1000P1U-4T3	1000.1	400-50	3	6,6	1440	71,1	55	-20/+50	91
OWL CWA 1000P2U-4T3	1000.2	400-50	3	6,6	1440	72	55	-20/+50	91
OWL CWA 1000P3U-4T4	1000.3	400-50	4	8,4	1440	72,7	55	-20/+50	106
OWL CWA 1000P4U-4T4	1000.4	400-50	4	8,4	1440	73,5	55	-20/+50	106
OWL CWA 1000P5U-4T5,5	1000.5	400-50	5,5	11,2	1440	73,4	55	-20/+50	123
OWL CWA 1000P6U-4T7,5	1000.6	400-50	7,5	15,4	1440	76,7	55	-20/+50	130
OWL CWA 1000P7U-4T11	1000.7	400-50	11	21,3	1440	78,4	55	-20/+50	191
OWL CWA 1000P8U-4T5,5	1000.8	400-50	5,5	11,2	1440	72,8	55	-20/+50	124
OWL CWA 1000P9U-4T7,5	1000.9	400-50	7,5	15,4	1440	74,3	55	-20/+50	131
OWL CWA 1000P10U-4T5,5	1000.10	400-50	5,5	11,2	1440	75,9	55	-20/+50	125
OWL CWA 1000P11U-4T7,5	1000.11	400-50	7,5	15,4	1440	79	55	-20/+50	132
OWL CWA 1000P12U-4T11	1000.12	400-50	11	21,3	1440	77	55	-20/+50	191
OWL CWA 1000P13U-4T11	1000.13	400-50	11	21,3	1440	77,4	55	-20/+50	191
OWL CWA 1000P14U-4T15	1000.14	400-50	15	29,8	1440	78,8	55	-20/+50	211
OWL CWA 1000P15U-4T15	1000.15	400-50	15	29,8	1440	79,4	55	-20/+50	211
OWL CWA 1000P16U-4T7,5	1000.16	400-50	7,5	15,4	1440	76,7	55	-20/+50	125
OWL CWA 1000P17U-4T7,5	1000.17	400-50	7,5	15,4	1440	76,3	55	-20/+50	125
OWL CWA 1000P18U-4T11	1000.18	400-50	11	21,3	1440	76,3	55	-20/+50	184
OWL CWA 1000P19U-4T11	1000.19	400-50	11	21,3	1440	77	55	-20/+50	184
OWL CWA 1000P20U-4T11	1000.20	400-50	11	21,3	1440	81,5	55	-20/+50	191
OWL CWA 1000P21U-4T11	1000.21	400-50	11	21,3	1440	81,5	55	-20/+50	191
OWL CWA 1000P22U-4T15	1000.22	400-50	15	29,8	1440	80,5	55	-20/+50	211
OWL CWA 1000P23U-4T15	1000.23	400-50	15	29,8	1440	79,4	55	-20/+50	211
OWL CWA 1000P24U-4T22	1000.24	400-50	22	42,5	1440	80,5	55	-20/+50	266
OWL CWA 1000P25.AU-4T11	1000.25.A	400-50	11	21,3	1440	74,3	55	-20/+50	195
OWL CWA 1000P25.BU-4T15	1000.25.B	400-50	15	29,8	1440	74,3	55	-20/+50	215
OWL CWA 1000P26U-4T15	1000.26	400-50	15	29,8	1440	76	55	-20/+50	215
OWL CWA 1000P27U-4T22	1000.27	400-50	22	42,5	1440	77,4	55	-20/+50	270
OWL CWA 1000P28U-4T30	1000.28	400-50	30	55	1440	80,1	55	-20/+50	277
OWL CWA 1000P29U-4T22	1000.29	400-50	22	42,5	1440	78,5	55	-20/+50	270
OWL CWA 1000P30U-4T30	1000.30	400-50	30	55	1440	78,8	55	-20/+50	285

MODEL	MODEL NUMBER	Voltage Frequency	Motor Power	Current	Rotation Speed	Sound Pressure	Protection Class	Working Range	Mass
		V-Hz	kW	A	RPM	Lp(A) dB at 3m	IP	°C	~ Kg
OWL CWA 1000P31U-4T7,5	1000.31	400-50	7,5	15,4	1440	79,8	55	-20/+50	126
OWL CWA 1000P32U-4T11	1000.32	400-50	11	21,3	1440	76,9	55	-20/+50	185
OWL CWA 1000P33U-4T15	1000.33	400-50	15	29,8	1440	76,4	55	-20/+50	205
OWL CWA 1000P34U-4T22	1000.34	400-50	22	42,5	1440	83,5	55	-20/+50	266
OWL CWA 1000P35U-4T22	1000.35	400-50	22	42,5	1440	83,5	55	-20/+50	266
OWL CWA 1000P36U-4T30	1000.36	400-50	30	55	1440	82,5	55	-20/+50	281
OWL CWA 1000P37U-4T37	1000.37	400-50	37	67	1440	81,5	55	-20/+50	381
OWL CWA 1120P1U-4T5,5	1120.1	400-50	5,5	11,2	1440	76,5	55	-20/+50	139
OWL CWA 1120P2U-4T7,5	1120.2	400-50	7,5	15,4	1440	77,1	55	-20/+50	146
OWL CWA 1120P3U-4T11	1120.3	400-50	11	21,3	1440	78,6	55	-20/+50	198
OWL CWA 1120P4U-4T11	1120.4	400-50	11	21,3	1440	78,8	55	-20/+50	196
OWL CWA 1120P5U-4T15	1120.5	400-50	15	29,8	1440	80,1	55	-20/+50	218
OWL CWA 1120P6U-4T18,5	1120.6	400-50	18,5	34,5	1440	81,5	55	-20/+50	258
OWL CWA 1120P7U-4T7,5	1120.7	400-50	7,5	15,4	1440	78,1	55	-20/+50	148
OWL CWA 1120P8U-4T11	1120.8	400-50	11	21,3	1440	81,5	55	-20/+50	198
OWL CWA 1120P9U-4T11	1120.9	400-50	11	21,3	1440	80,5	55	-20/+50	198
OWL CWA 1120P10U-4T15	1120.10	400-50	15	29,8	1440	79,3	55	-20/+50	218
OWL CWA 1120P11U-4T15	1120.11	400-50	15	29,8	1440	78,8	55	-20/+50	218
OWL CWA 1120P12U-4T18,5	1120.12	400-50	18,5	34,5	1440	80,5	55	-20/+50	258
OWL CWA 1120P13U-4T22	1120.13	400-50	22	42,5	1440	81,5	55	-20/+50	273
OWL CWA 1120P14U-4T22	1120.14	400-50	22	42,5	1440	82,5	55	-20/+50	273
OWL CWA 1120P15U-4T22	1120.15	400-50	22	42,5	1440	81,5	55	-20/+50	273
OWL CWA 1120P16U-4T11	1120.16	400-50	11	21,3	1440	83,5	55	-20/+50	198
OWL CWA 1120P17U-4T15	1120.17	400-50	15	29,8	1440	83,5	55	-20/+50	218
OWL CWA 1120P18U-4T15	1120.18	400-50	15	29,8	1440	83,5	55	-20/+50	218
OWL CWA 1120P19U-4T22	1120.19	400-50	22	42,5	1440	81,5	55	-20/+50	273
OWL CWA 1120P20U-4T30	1120.20	400-50	30	55	1440	84,5	55	-20/+50	298
OWL CWA 1120P21U-4T5,5	1120.21	400-50	5,5	11,2	1440	84,5	55	-20/+50	136
OWL CWA 1120P22U-4T7,5	1120.22	400-50	7,5	15,4	1440	84,5	55	-20/+50	143
OWL CWA 1120P23U-4T11	1120.23	400-50	11	21,3	1440	80,1	55	-20/+50	192
OWL CWA 1120P24U-4T15	1120.24	400-50	15	29,8	1440	79,6	55	-20/+50	212
OWL CWA 1120P25U-4T18,5	1120.25	400-50	18,5	34,5	1440	78,6	55	-20/+50	252
OWL CWA 1120P26U-4T11	1120.26	400-50	11	21,3	1440	84,5	55	-20/+50	202
OWL CWA 1120P27U-4T15	1120.27	400-50	15	29,8	1440	84,5	55	-20/+50	222
OWL CWA 1120P28U-4T15	1120.28	400-50	15	29,8	1440	83,5	55	-20/+50	222
OWL CWA 1120P29U-4T18,5	1120.29	400-50	18,5	34,5	1440	82,5	55	-20/+50	262
OWL CWA 1120P30U-4T18,5	1120.30	400-50	18,5	34,5	1440	82,5	55	-20/+50	262
OWL CWA 1120P31U-4T22	1120.31	400-50	22	42,5	1440	82,5	55	-20/+50	277
OWL CWA 1120P32U-4T30	1120.32	400-50	30	55	1440	81,5	55	-20/+50	302
OWL CWA 1120P33U-4T37	1120.33	400-50	37	67	1440	81,5	55	-20/+50	402
OWL CWA 1120P34U-4T22	1120.34	400-50	22	42,5	1440	83,5	55	-20/+50	283
OWL CWA 1120P35U-4T30	1120.35	400-50	30	55	1440	82,5	55	-20/+50	298
OWL CWA 1120P36U-4T15	1120.36	400-50	15	29,8	1440	85,5	55	-20/+50	227
OWL CWA 1120P37U-4T22	1120.37	400-50	22	42,5	1440	82,5	55	-20/+50	282
OWL CWA 1120P38U-4T45	1120.38	400-50	45	80	1440	82,5	55	-20/+50	507
OWL CWA 1120P39U-4T22	1120.39	400-50	22	42,5	1440	78,1	55	-20/+50	269

MODEL	MODEL NUMBER	Voltage Frequency	Motor Power	Current	Rotation Speed	Sound Pressure	Protection Class	Working Range	Mass
		V-Hz	kW	A	RPM	Lp(A) dB at 3m	IP	°C	~ Kg
OWL CWA 1120P40U-4T30	1120.40	400-50	30	55	1440	79,1	55	-20/+50	294
OWL CWA 1250P1U-4T11	1250.1	400-50	11	21,3	1440	84,5	55	-20/+50	211
OWL CWA 1250P2U-4T15	1250.2	400-50	15	29,8	1440	83,5	55	-20/+50	231
OWL CWA 1250P3U-4T18,5	1250.3	400-50	18,5	34,5	1440	83,5	55	-20/+50	271
OWL CWA 1250P4U-4T18,5	1250.4	400-50	18,5	34,5	1440	83,5	55	-20/+50	271
OWL CWA 1250P5U-4T22	1250.5	400-50	22	42,5	1440	83,5	55	-20/+50	286
OWL CWA 1250P6U-4T11	1250.6	400-50	11	21,3	1440	88,5	55	-20/+50	211
OWL CWA 1250P7U-4T18,5	1250.7	400-50	18,5	34,5	1440	89,5	55	-20/+50	271
OWL CWA 1250P8U-4T22	1250.8	400-50	22	42,5	1440	89,5	55	-20/+50	286
OWL CWA 1250P9U-4T22	1250.9	400-50	22	42,5	1440	89,5	55	-20/+50	286
OWL CWA 1250P10U-4T22	1250.10	400-50	22	42,5	1440	89,5	55	-20/+50	286
OWL CWA 1250P11U-4T30	1250.11	400-50	30	55	1440	87,5	55	-20/+50	317
OWL CWA 1250P12U-4T30	1250.12	400-50	30	55	1440	88,5	55	-20/+50	317
OWL CWA 1250P13U-4T30	1250.13	400-50	30	55	1440	82,5	55	-20/+50	317
OWL CWA 1250P14U-4T30	1250.14	400-50	30	55	1440	88,5	55	-20/+50	317
OWL CWA 1250P15U-4T30	1250.15	400-50	30	55	1440	83,5	55	-20/+50	317
OWL CWA 1250P16U-4T30	1250.16	400-50	30	55	1440	84,5	55	-20/+50	317
OWL CWA 1250P17U-4T37	1250.17	400-50	37	67	1440	84,5	55	-20/+50	417
OWL CWA 1250P18U-4T37	1250.18	400-50	37	67	1440	84,5	55	-20/+50	417
OWL CWA 1250P19U-4T37	1250.19	400-50	37	67	1440	84,5	55	-20/+50	417
OWL CWA 1250P20U-4T45	1250.20	400-50	45	80	1440	84,5	55	-20/+50	517
OWL CWA 1250P21U-4T45	1250.21	400-50	45	80	1440	84,5	55	-20/+50	517
OWL CWA 1250P22U-4T45	1250.22	400-50	45	80	1440	84,5	55	-20/+50	517
OWL CWA 1250P23U-4T45	1250.23	400-50	45	80	1440	42,5	55	-20/+50	517
OWL CWA 1250P24U-4T45	1250.24	400-50	45	80	1440	85,5	55	-20/+50	517
OWL CWA 1250P25U-4T55	1250.25	400-50	55	96,8	1440	86,5	55	-20/+50	547
OWL CWA 1250P26U-4T55	1250.26	400-50	55	96,8	1440	86,5	55	-20/+50	547
OWL CWA 1250P27U-4T55	1250.27	400-50	55	96,8	1440	86,5	55	-20/+50	547
OWL CWA 1250P28U-4T22	1250.28	400-50	22	42,5	1440	89,5	55	-20/+50	286
OWL CWA 1250P29.AU-4T22	1250.29.A	400-50	22	42,5	1440	89,5	55	-20/+50	286
OWL CWA 1250P29.BU-4T30	1250.29.B	400-50	30	55	1440	89,5	55	-20/+50	317
OWL CWA 1250P30U-4T30	1250.30	400-50	30	55	1440	87,5	55	-20/+50	317
OWL CWA 1250P31.AU-4T30	1250.31.A	400-50	30	55	1440	87,5	55	-20/+50	317
OWL CWA 1250P31.BU-4T37	1250.31.B	400-50	37	67	1440	87,5	55	-20/+50	417
OWL CWA 1250P32U-4T45	1250.32	400-50	45	80	1440	85,5	55	-20/+50	517
OWL CWA 1250P33U-4T55	1250.33	400-50	55	96,8	1440	84,5	55	-20/+50	547
OWL CWA 1250P34U-4T55	1250.34	400-50	55	96,8	1440	84,5	55	-20/+50	547
OWL CWA 1250P35U-4T55	1250.35	400-50	55	96,8	1440	84,5	55	-20/+50	547
OWL CWA 1250P36U-4T11	1250.36	400-50	11	21,3	1440	77,5	55	-20/+50	216
OWL CWA 1250P37U-4T18,5	1250.37	400-50	18,5	34,5	1440	79,8	55	-20/+50	276
OWL CWA 1250P38U-4T22	1250.38	400-50	22	42,5	1440	80,4	55	-20/+50	291
OWL CWA 1250P39U-4T30	1250.39	400-50	30	55	1440	85,5	55	-20/+50	322
OWL CWA 1250P40U-4T30	1250.40	400-50	30	55	1440	86,5	55	-20/+50	322
OWL CWA 1250P41U-4T37	1250.41	400-50	37	67	1440	83,5	55	-20/+50	422
OWL CWA 1250P42U-4T37	1250.42	400-50	37	67	1440	84,5	55	-20/+50	422

NOVVES

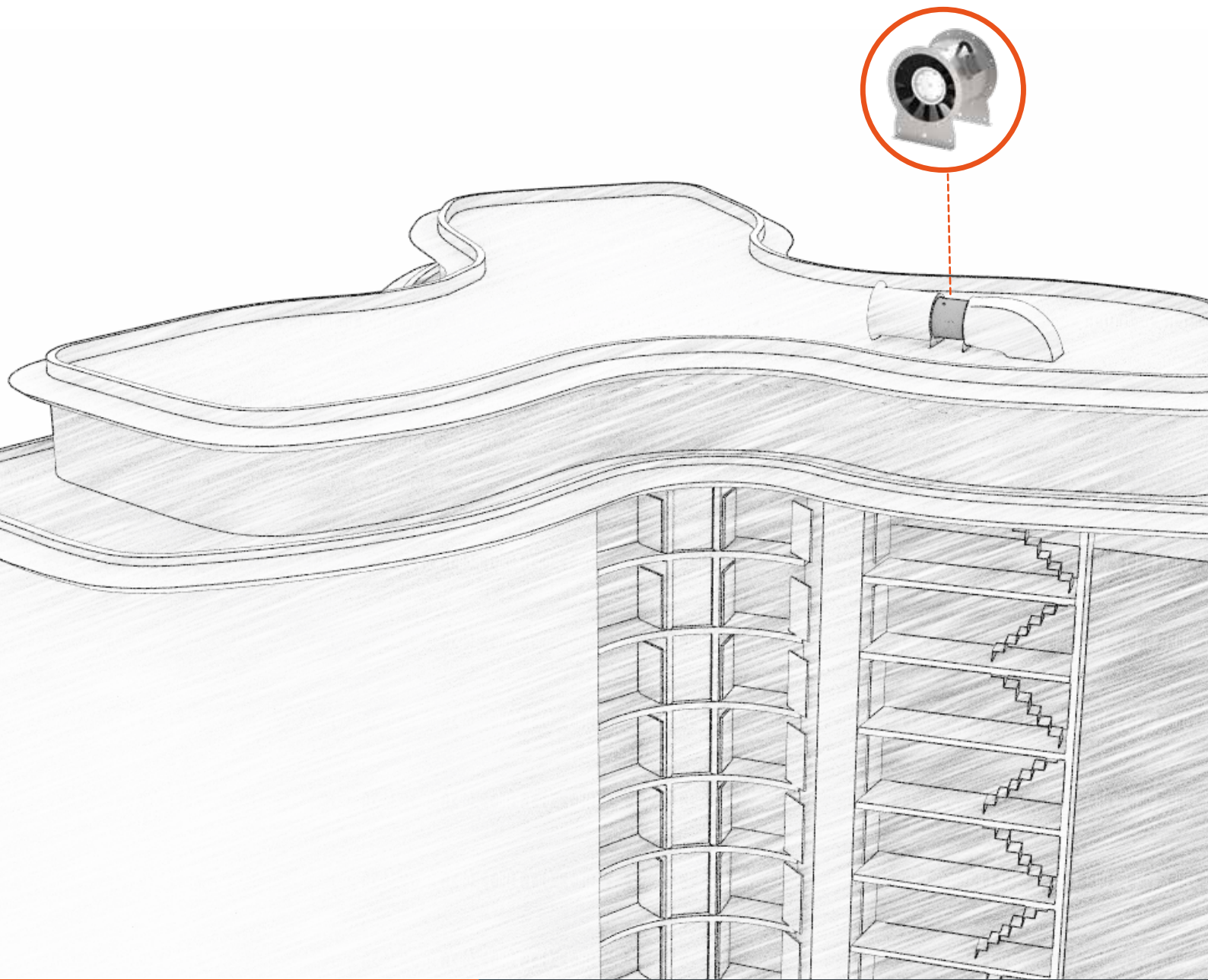

Marlin
Axial Fan

MARLIN SERIES



General

In addition to being used as a fresh air fan, exhaust fan or duct type fan, MARLIN series fans can also be used as pressurizing fans to prevent smoke from entering the escape routes of buildings such as stairs and elevators during a fire. The fans in this series, which have a wide usage area, can be used in any area that needs fresh air. With their compact structure, they can also be mounted directly to air ducts, inside the shaft, and on the roof floor. It offers high performance with low noise level in the area where it is installed.

Body

The body, which is made of electrostatic powder coated steel, can also be produced from hot-dip galvanized optionally. The motor is connected to the main body with steel carriers.

Impeller

Axial blades with aerodynamically optimized aerofoil, provide high efficiency. The blades are glass fiber reinforced composite material. The impellers are dynamically and statically balanced in accordance with ISO 1940.

Motor

All models are equipped with a three-phase asynchronous motor. It can be used in the exhaust of air up to 50°C.

IP Class

It has IP 55 protection and F class insulation.

Control

It can work directly with the help of MCC board. Speed adjustment can be made with frequency inverter.

Fan Code

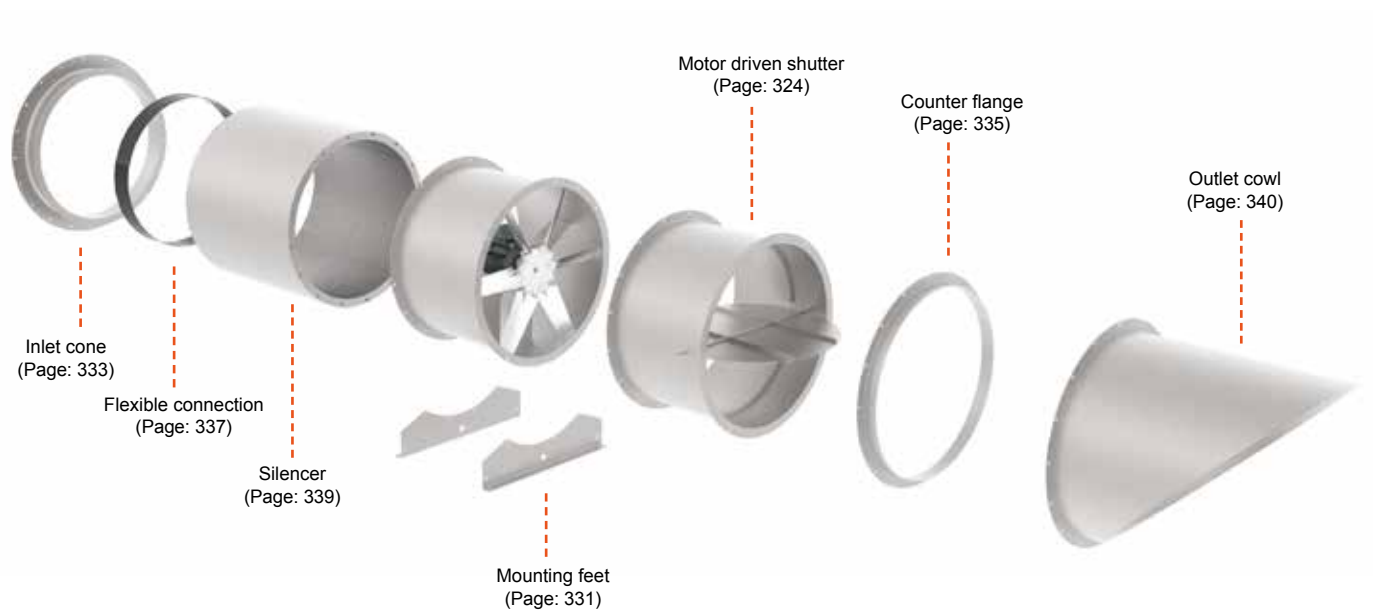
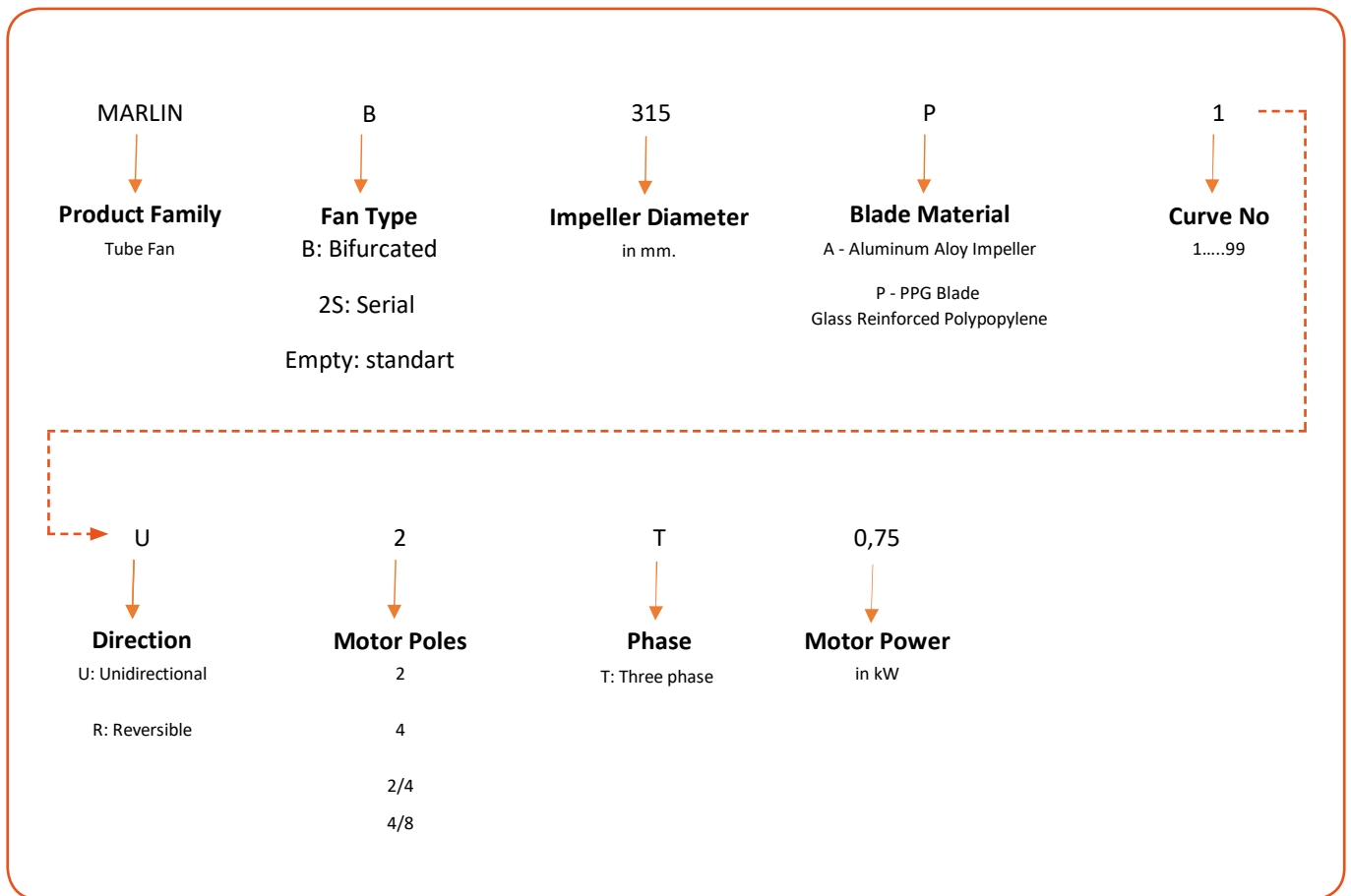

NOVVES PRESSURIZATION SYSTEM SOLUTIONS

In case of a possible fire in a building, escape routes are required for the evacuation of the people in the building. At this stage, fire escapes are also classified as escape routes. In order to ensure a healthy evacuation of people outside the building, escape routes should be made into areas protected from smoke. In these systems, the application can be done by blowing from a single point into the stairwell or by blowing from multiple points through a channel running along the stairwell. In both applications, blowing can be done from the top or bottom of the stairwell, but it is generally preferred to blow from the top of the stairwell as it is easier to apply.

In blowing from a single point, situations that would prevent the opening of fire doors in areas close to the blowing point and situations in which smoke entry into the stairwell could not be prevented in remote areas were determined. Since a homogeneous pressure distribution is achieved within the building, it has been determined by the researches that blowing from multiple points is a more accurate application.

The following situations are taken into consideration when calculating the Stair Pressurization Systems;

- The amount of air supplied to the stairwell
- Air and smoke leaks in adjacent spaces
- Indoor pressure balance
- Chimney effect
- Wind effect
- Thermal expansion

In combination of all these factors, positive pressure should be obtained between the stairwell and the adjacent volumes.

NOVVES performs system designs in accordance with European norms.

“EN 12101-6 Smoke and heat control systems: Specifications for differential pressure systems”

- 1. Stair Pressurization Fans:** Provides air supply to the ladder area and creates positive pressure in the environment. Fan suction must be in a smoke-free area.
- 2. Ducts:** It provides air transmission from the fan to the floors subject to the ladder area (In high-rise buildings, to spread the pressure in the environment homogeneously it is necessary to inject air on every floor or two floors).
- 3. Differential Pressure Sensor:** The differential pressure sensor transmits information to the control panel when the pressure difference between the pressurized medium and the corridor reaches 50 Pa or more.
- 4. Duct Type Smoke Sensor:** It transmits information to the control panel and stops the fan in case of mixing with the fresh air, which is formed in the facade fires, which is used for pressurization.
- 5. Relief Dampers:** It provides homogeneous air distribution to the ladder slot and prevents air passage to floors with closed doors.
- 6. Motorized Fan Damper:** If smoke reaches the suction of the fan, it prevents the smoke from reaching the pressurized volume.
- 7. Automation Panel:** Operates the fan in line with the fire information coming from the fire panel. With the help of the frequency inverter in it and the information coming from the sensors, it ensures that the pressure in the environment is kept at a certain level that will not prevent the doors from opening to the escape route. In case of smoke reaching the suction of the pressurizing fan, the fan operation is stopped. The natural air flow is also closed with the damper in the suction part.

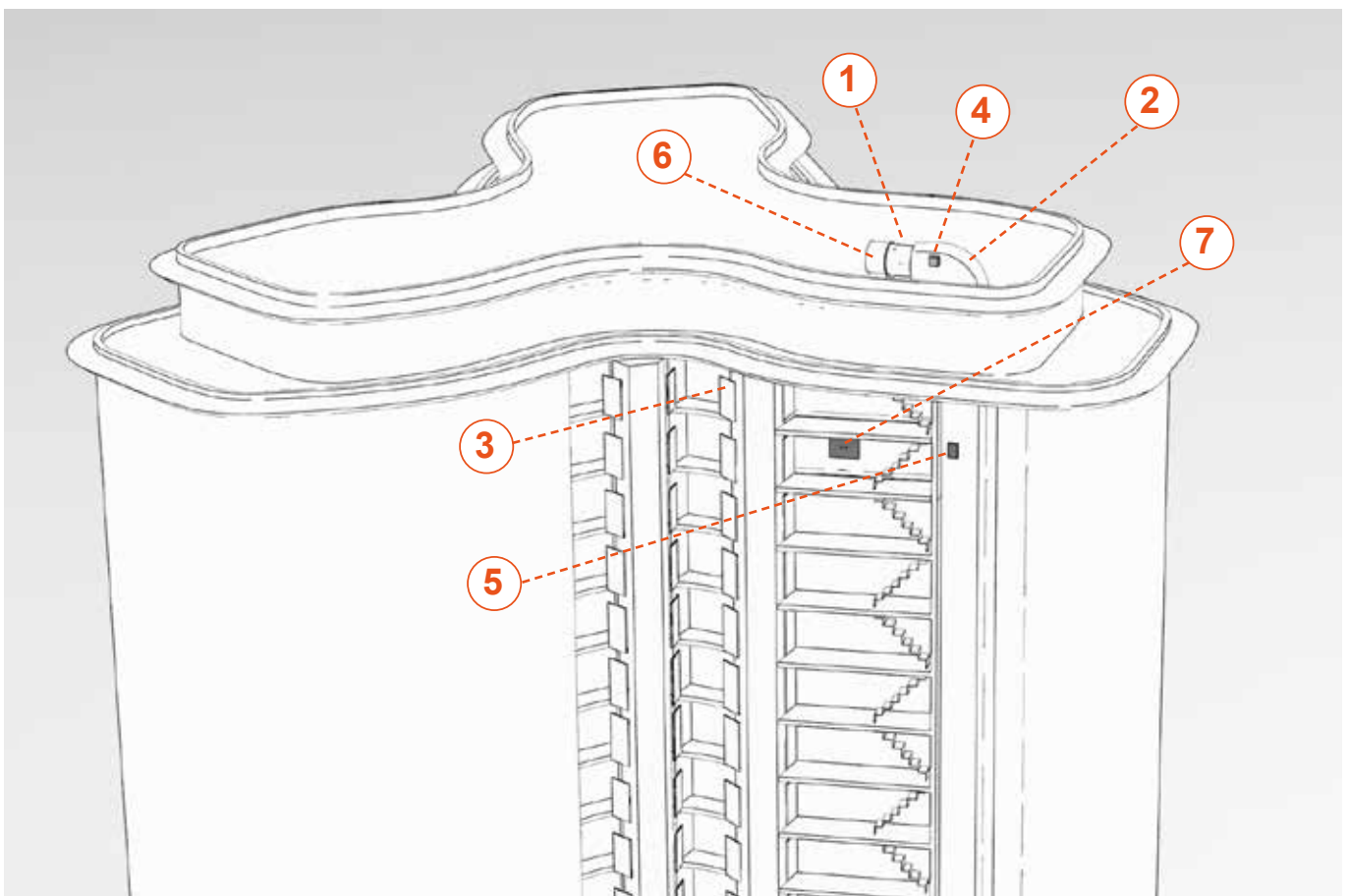

AXIAL TUBE FANS



- Body is electrostatic powder painted for resistance to corrosion, optional hot dip galvanized sheet
- Double speed motor option,
- Adjustable blade angle
- Propeller material is glass fiber composite material
- Suitable for horizontal and vertical mounting
- The Fan can be used for fresh air or air exhaust up to 50°C
- Rotational speed can be set with frequency inverter

MARLIN - SYSTEM CURVE - 2 POLES

Ø315 / 3-4 Blade

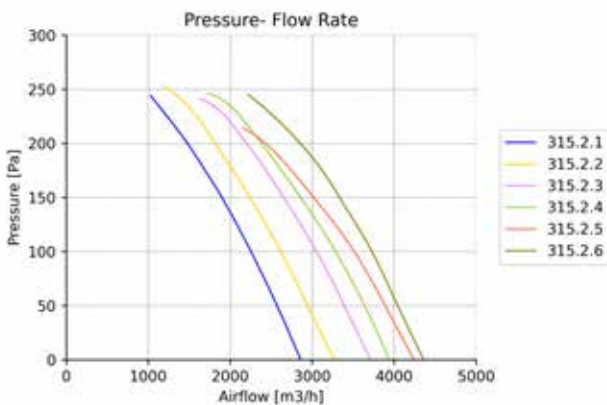

Ø315 / 6 Blade

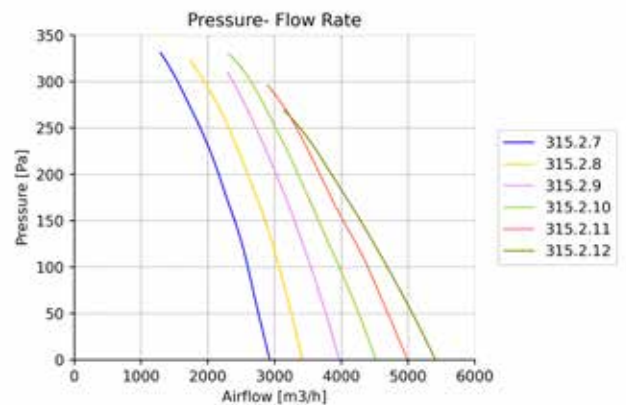

Ø355 / 3 Blade

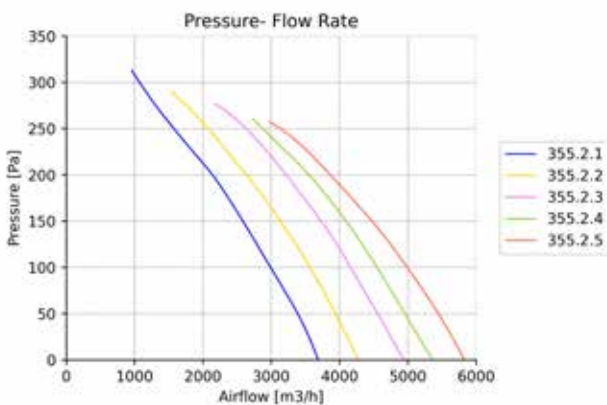

Ø355 / 4-6-8 Blade

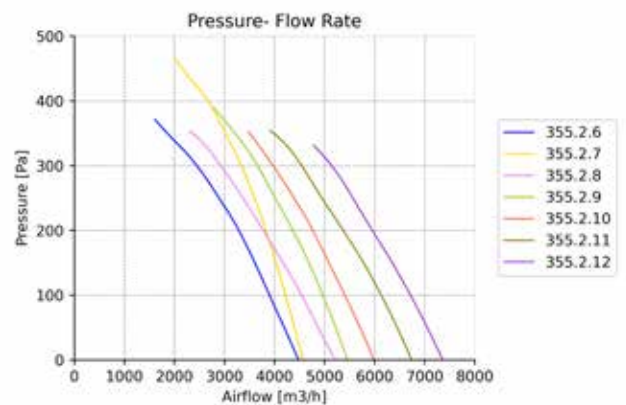

MARLIN - SYSTEM CURVE - 2 POLES

Ø400 / 3-4-5 Blade

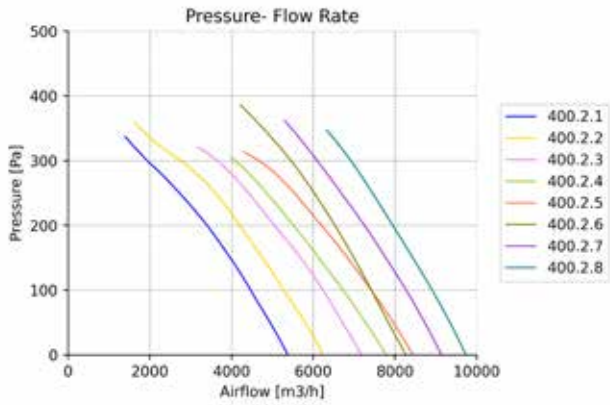

Ø400 / 6-8-10 Blade

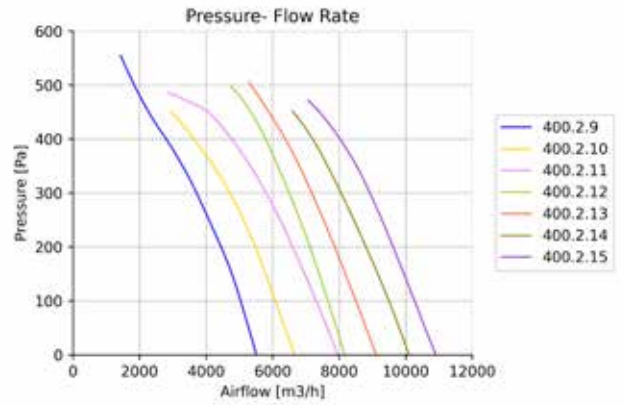

Ø450 / 3-4-6 Blade

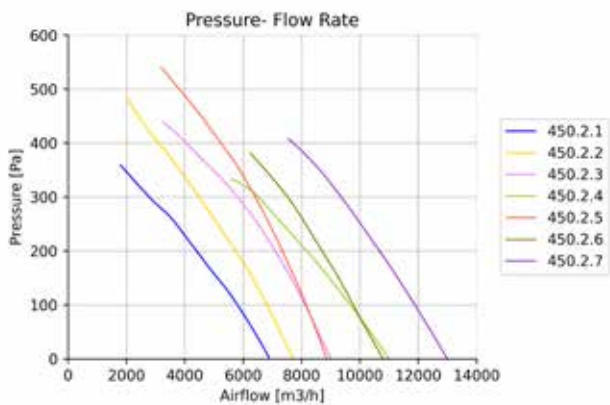

Ø450 / 5-6-8 Blade

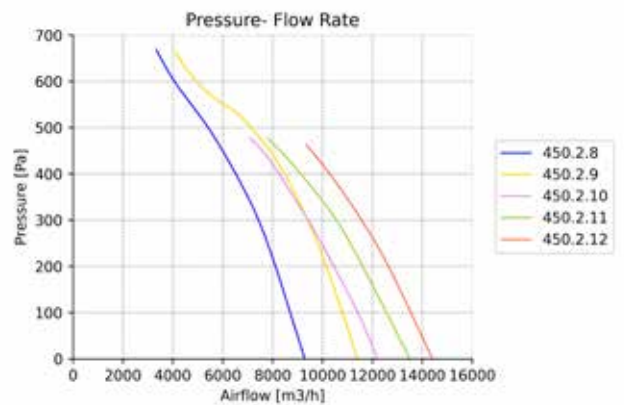

Ø450 / 10 Blade

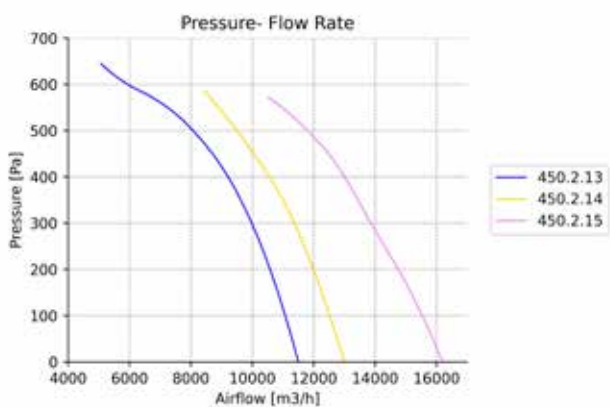

Ø500 / 3-4 Blade

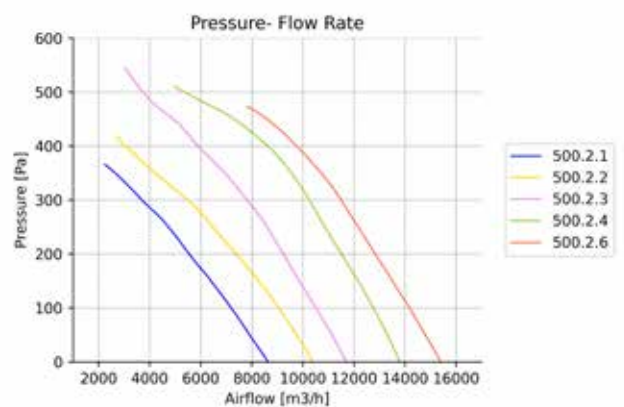

MARLIN - SYSTEM CURVE - 2 POLES

Ø500 / 5 Blade

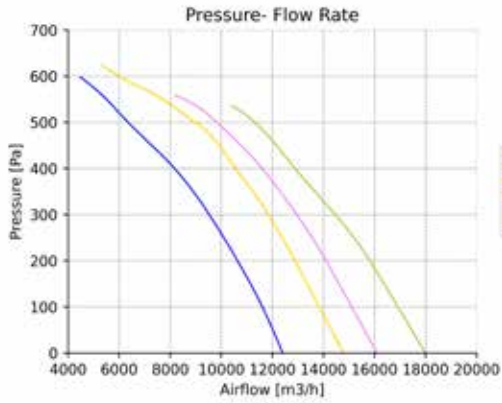

Ø500 / 10 Blade

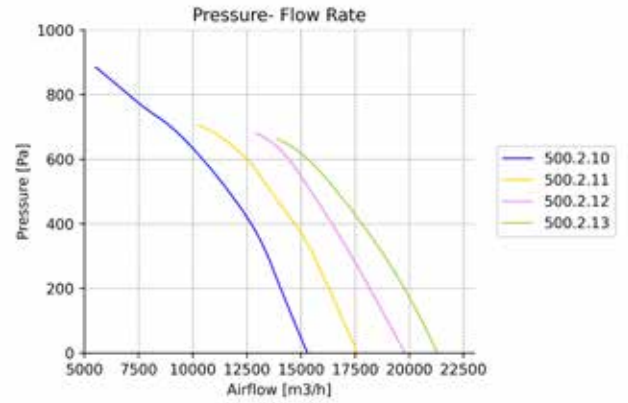

Ø560 / 3-4-5 Blade

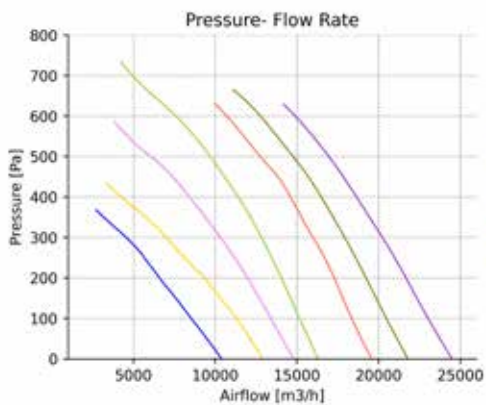

Ø560 / 6 Blade

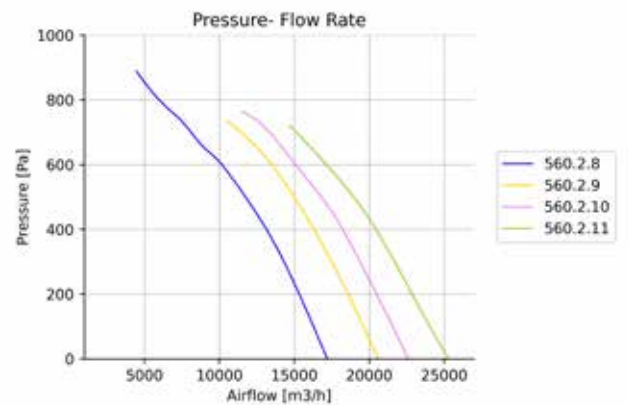

Ø560 / 10 Blade

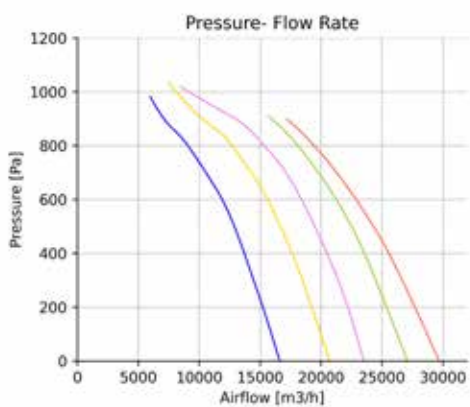

Ø630 / 3-4-5-6 Blade

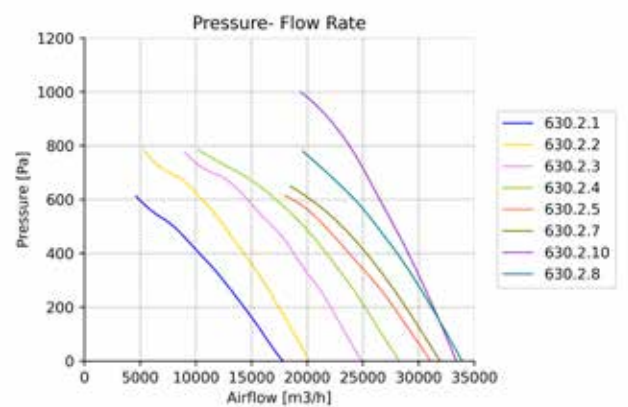

MARLIN - SYSTEM CURVE - 2 POLES

Ø630 / 6-10-12 Blade

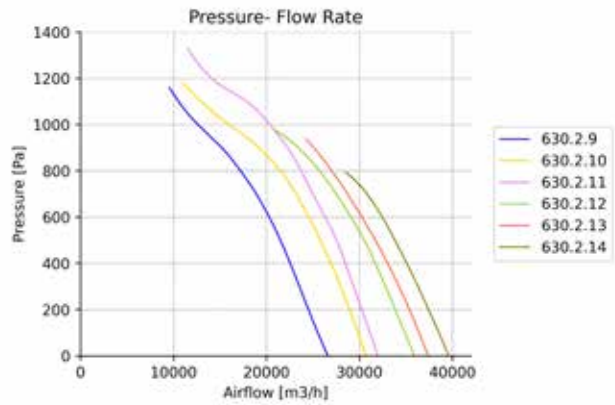

Ø710 / 3-6 Blade

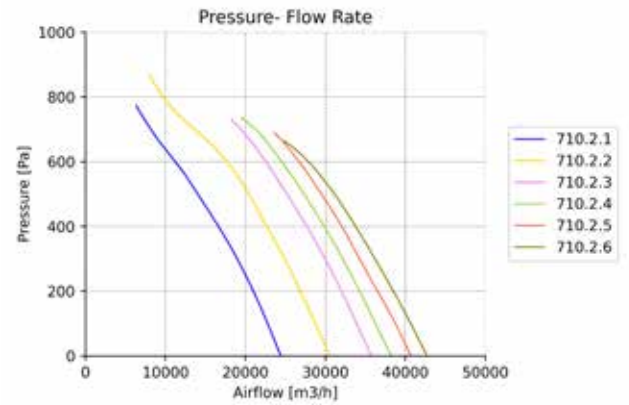

Ø710 / 6-12 Blade

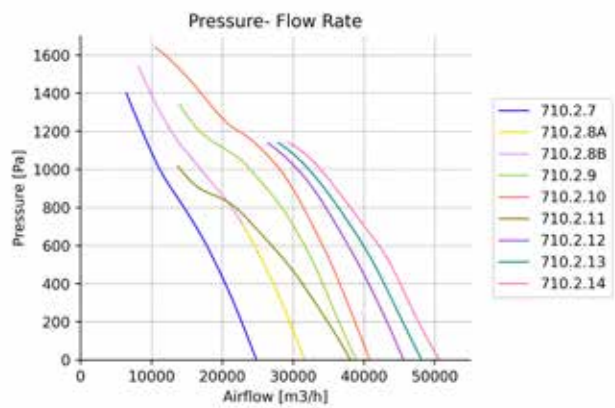

Ø800 / 3-6 Blade

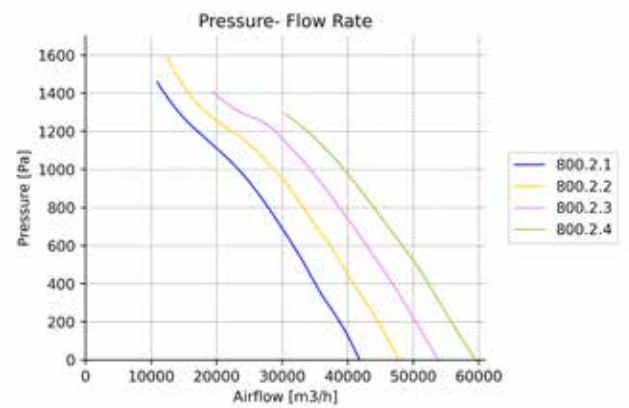

Ø800 / 6-6 Blade

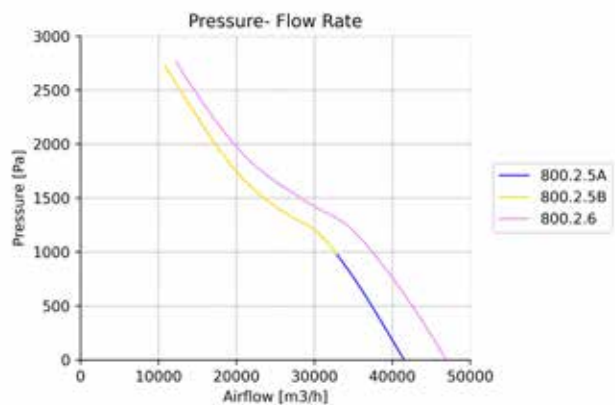

MARLIN - SYSTEM CURVE - 4 POLES

Ø315 / 3-6 Blade

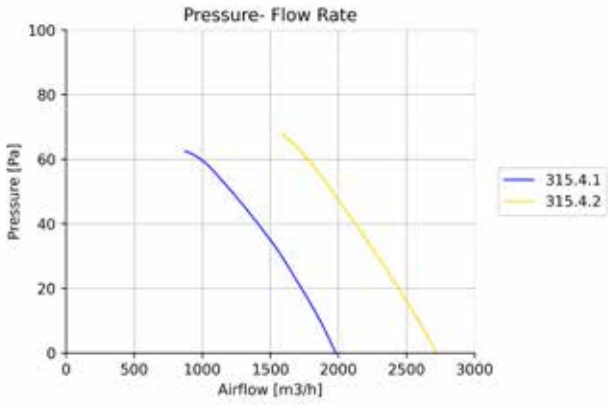

Ø355 / 4-6 Blade

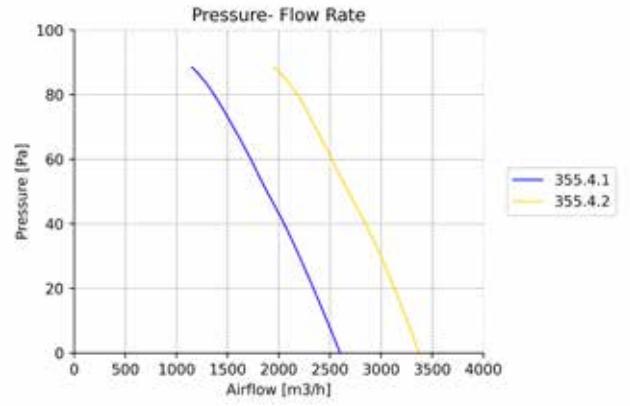

Ø400 / 6-8 Blade

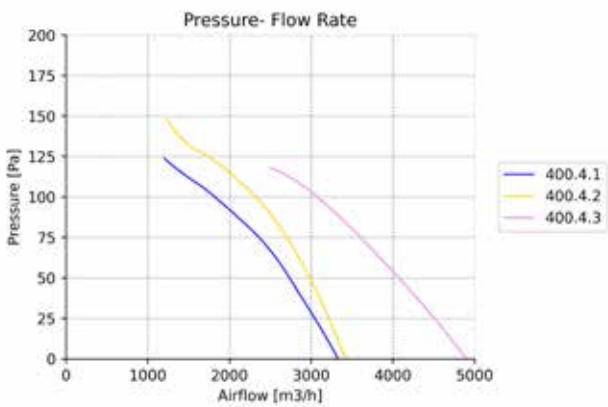

Ø450 / 6-8-10 Blade

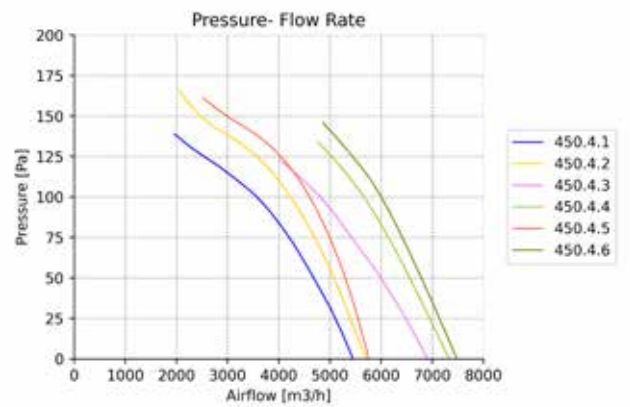

Ø500 / 6-8-10-12 Blade

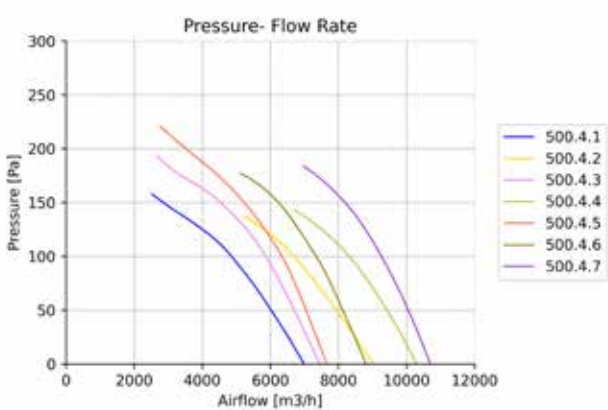

Ø560 / 3-4-6-8 Blade

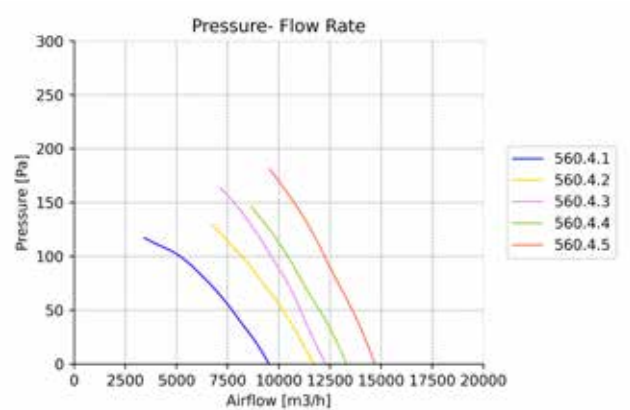

MARLIN - SYSTEM CURVE - 4 POLES

Ø560 / 10-12 Blade

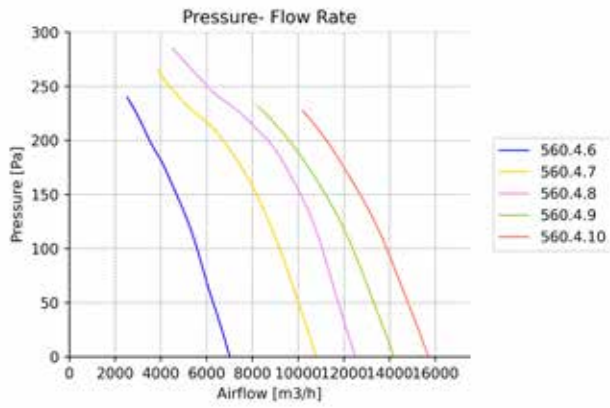

Ø630 / 5-6-8 Blade

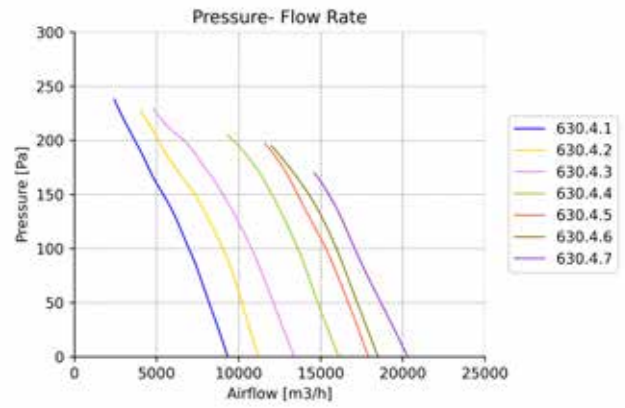

Ø630 / 10-12 Blade

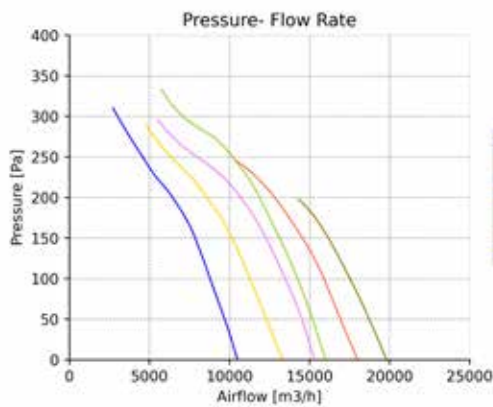

Ø630 / 9-12 Blade

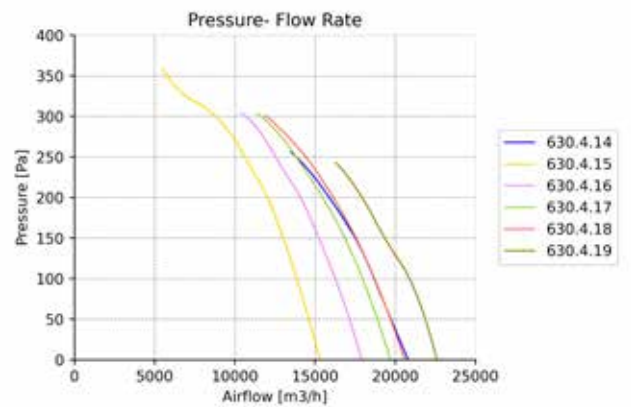

Ø710 / 5-6 Blade

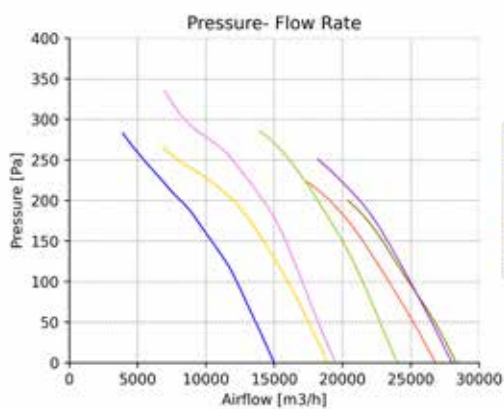

Ø710 / 9-12 Blade

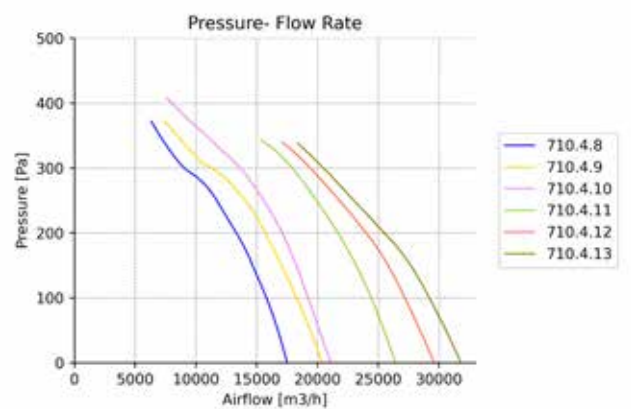

MARLIN - SYSTEM CURVE - 4 POLES

Ø800 / 6 Blade

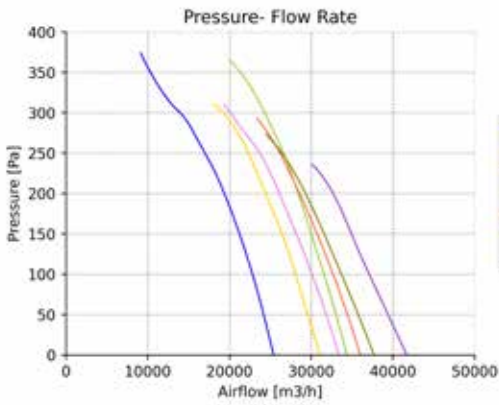

Ø800 / 8 Blade

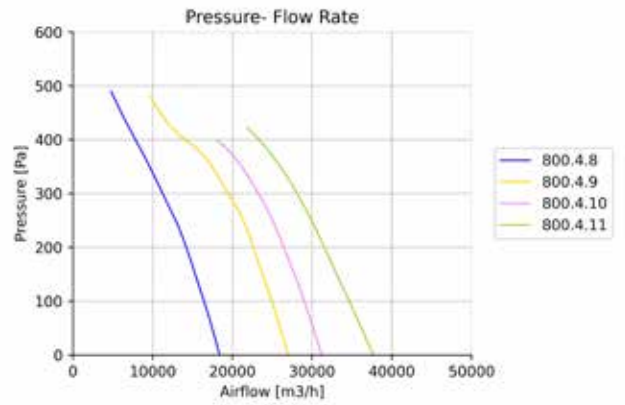

Ø800 / 9-12 Blade

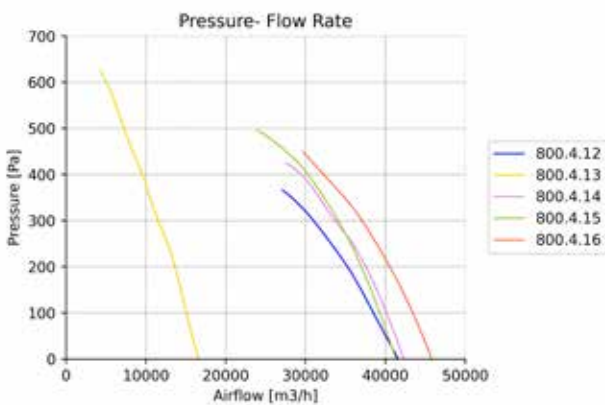

Ø800 / 6 Blade

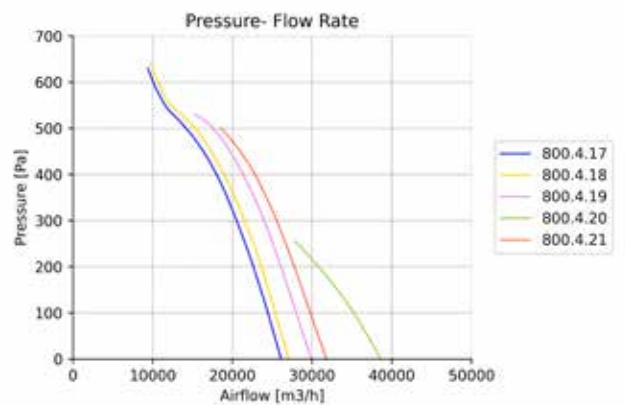

Ø900 / 6 Blade

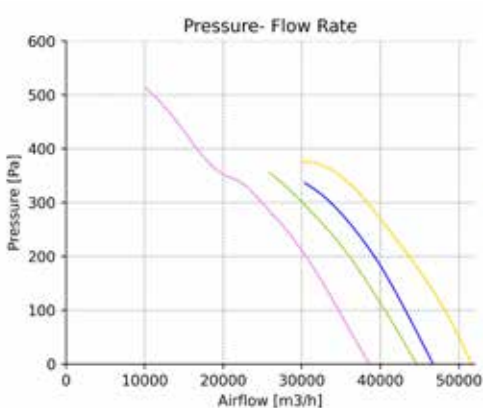

Ø900 / 8 Blade

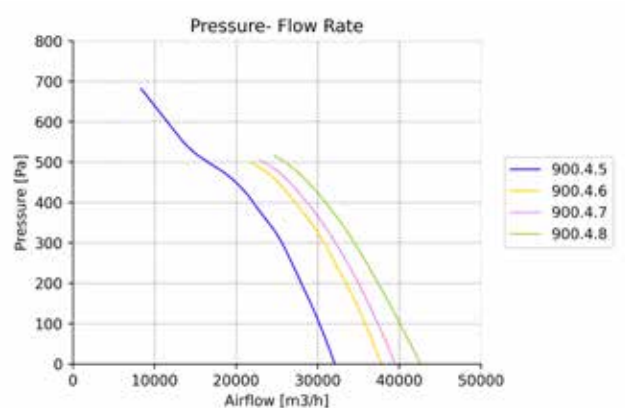

MARLIN - SYSTEM CURVE - 4 POLES

Ø900 / 9 Blade

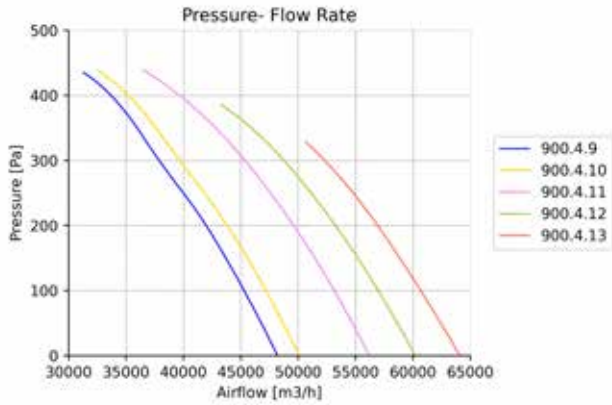

Ø900 / 12 Blade

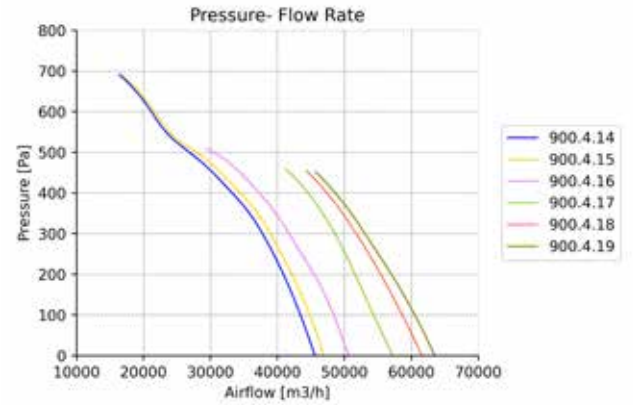

Ø900 / 6 Blade

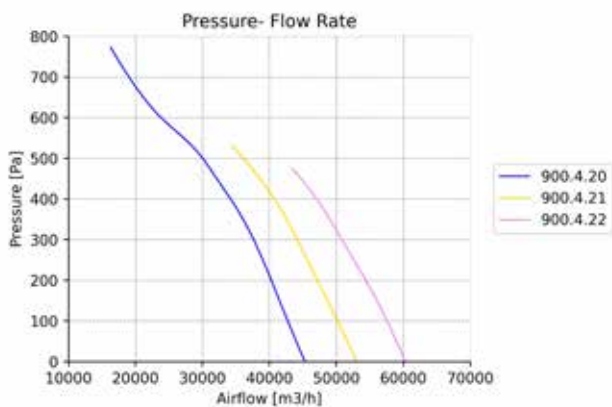

Ø1000 / 3 Blade

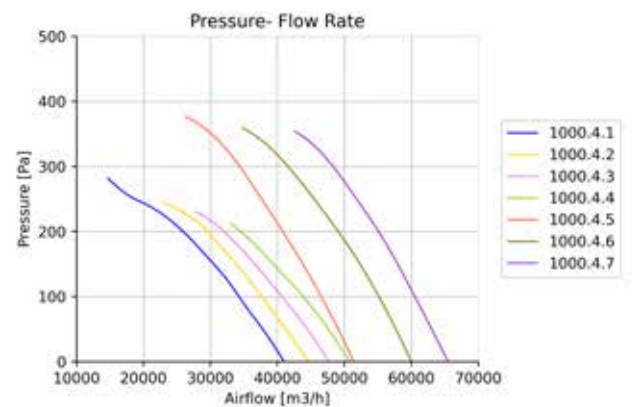

Ø1000 / 5-6 Blade

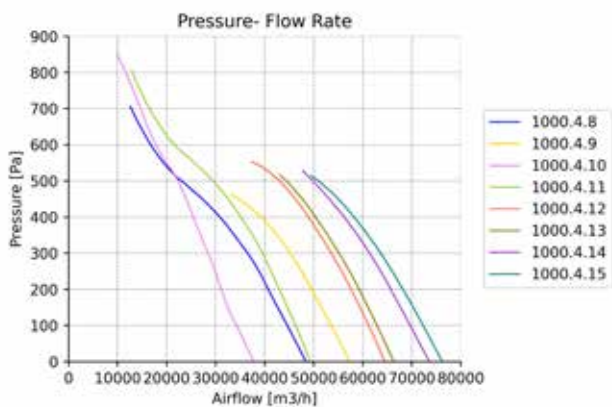

Ø1000 / 6 Blade

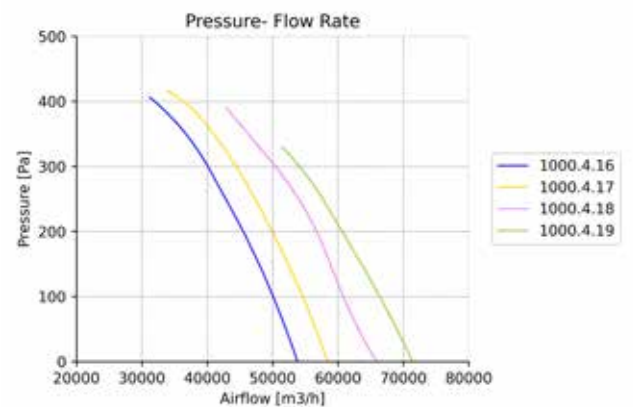

MARLIN - SYSTEM CURVE - 4 POLES

Ø1000 / 6 Blade

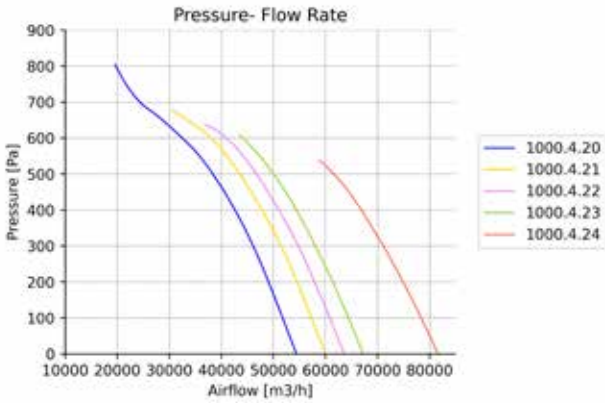

Ø1000 / 8 Blade

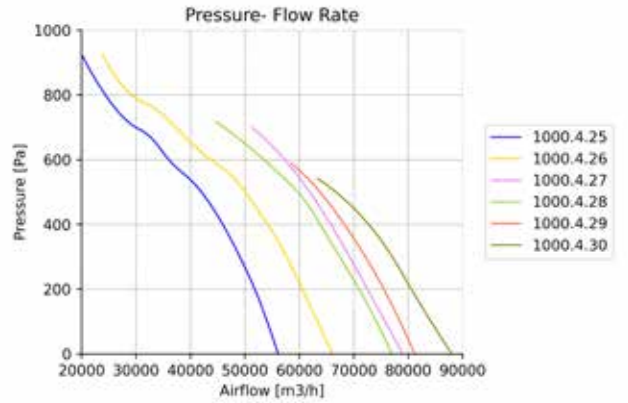

Ø1000 / 9 Blade

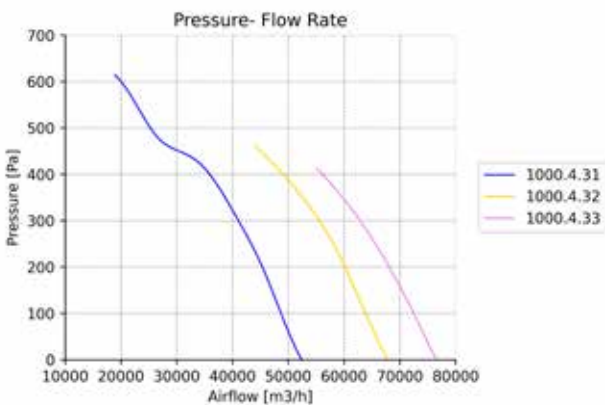

Ø1000 / 10 Blade

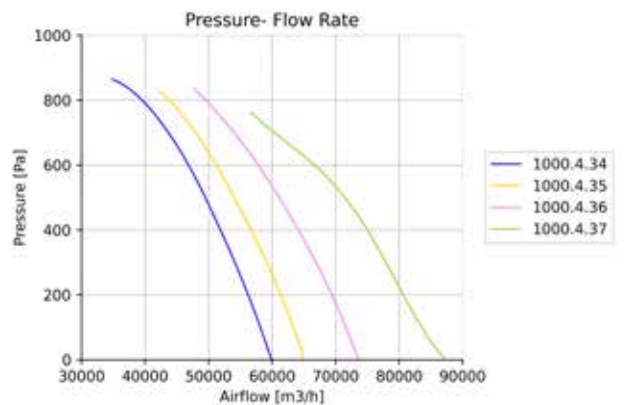

Ø1120 / 3 Blade

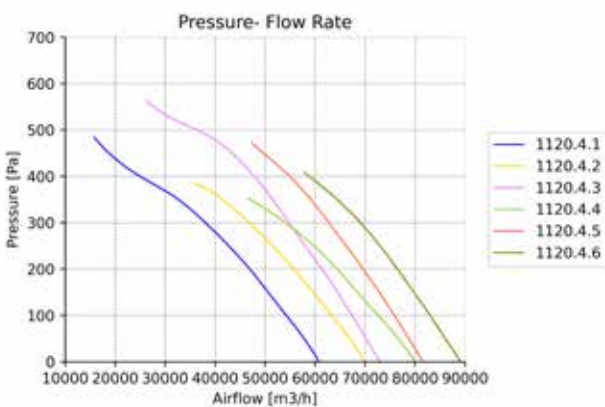

Ø1120 / 6 Blade

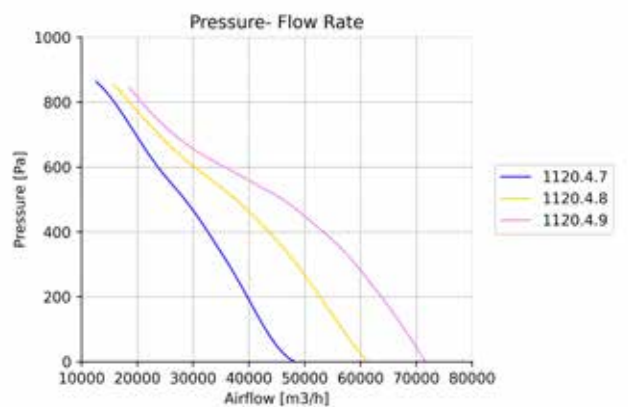

MARLIN - SYSTEM CURVE - 4 POLES

Ø1120 / 6 Blade

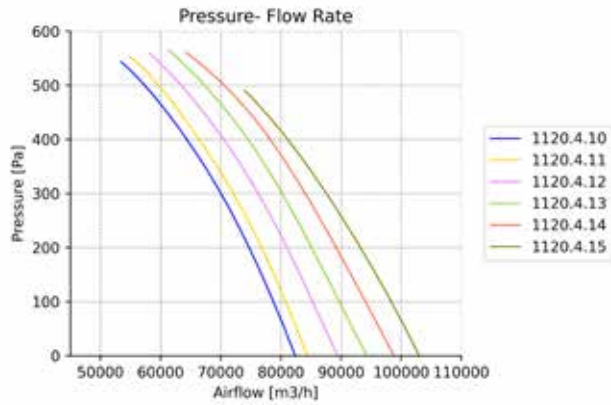

Ø1120 / 6 Blade

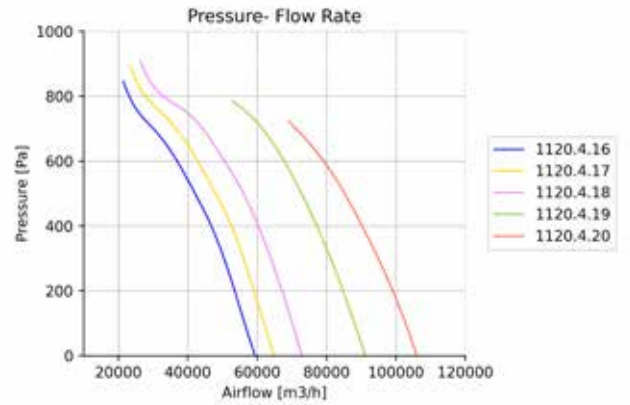

Ø1120 / 8 Blade

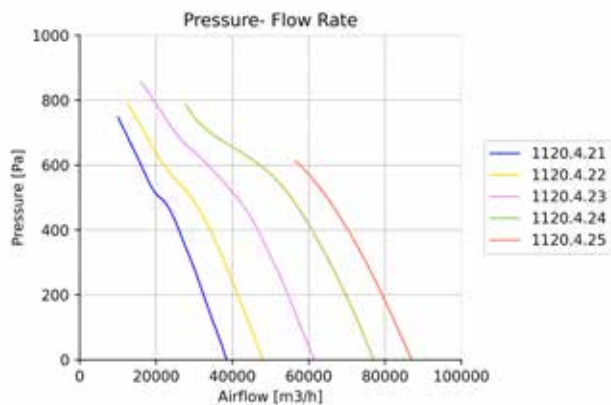

Ø1120 / 8 Blade

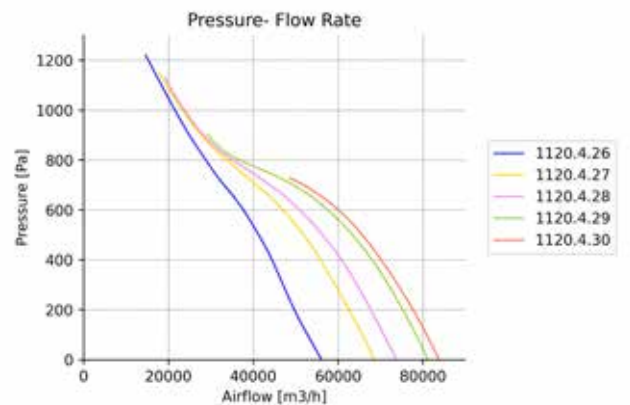

Ø1120 / 8 Blade

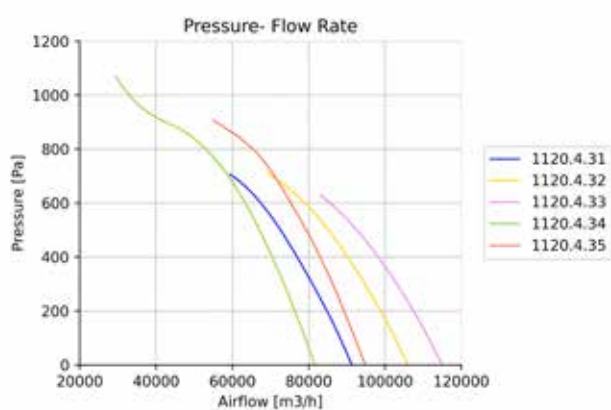

Ø1120 / 10-12 Blade

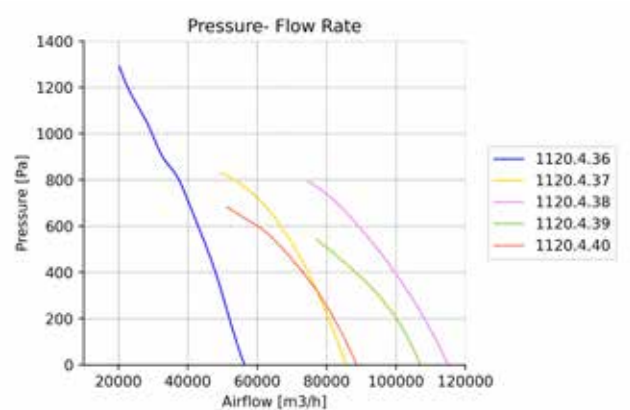

MARLIN - SYSTEM CURVE - 4 POLES

Ø1250 / 3 Blade

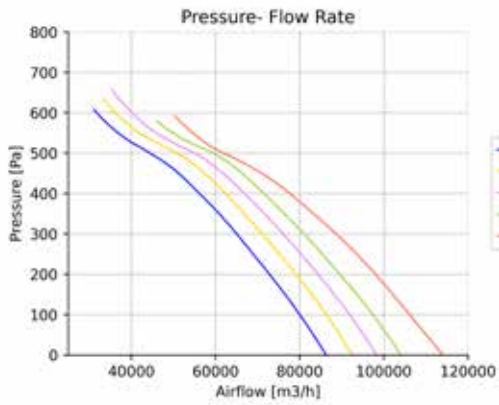

Ø1250 / 6 Blade

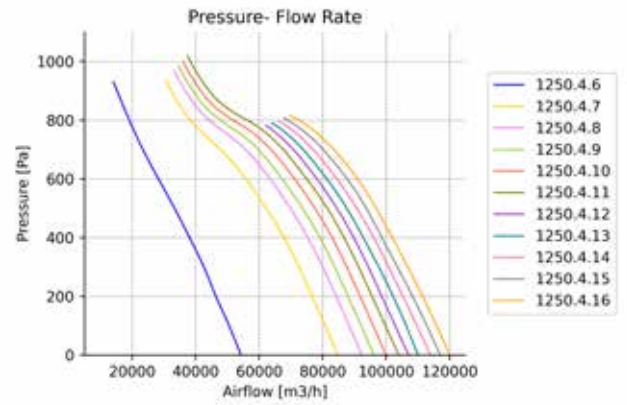

Ø1250 / 6 Blade

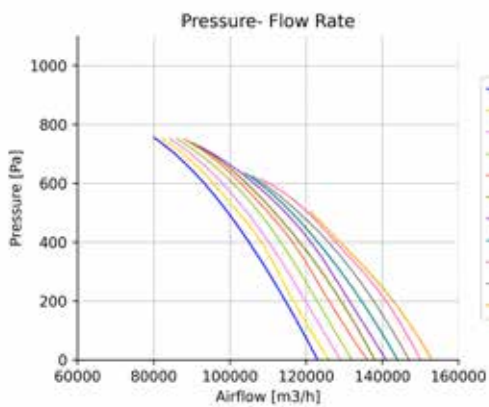

Ø1250 / 8 Blade

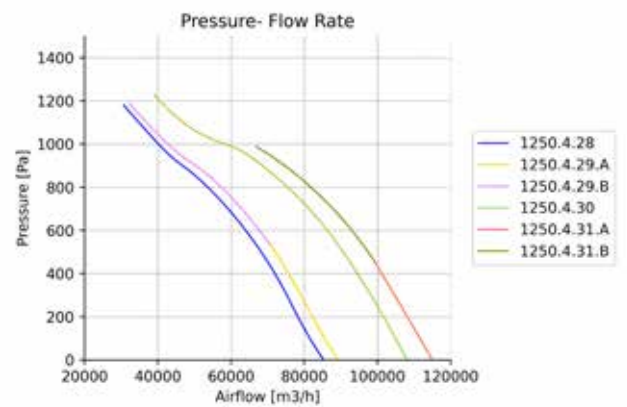

Ø1250 / 8 Blade

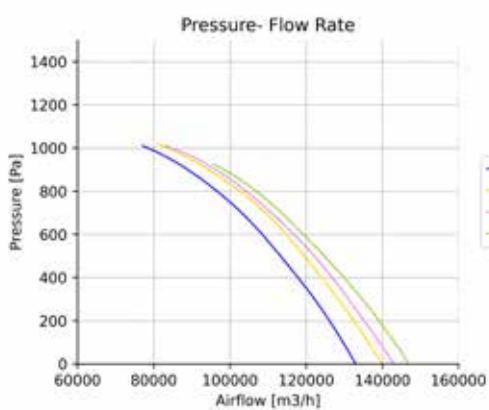

Ø1250 / 5 Blade

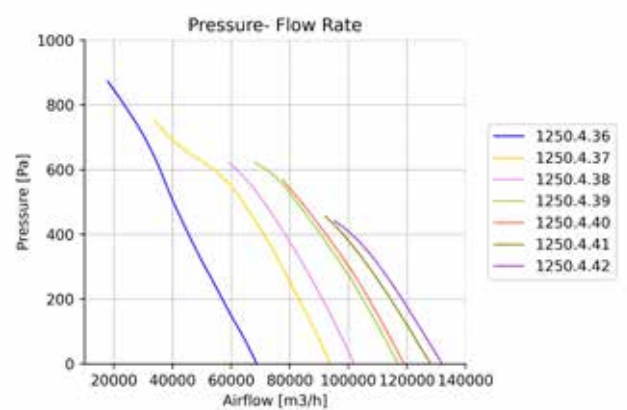

MARLIN - SYSTEM CURVE - 4 POLES

Ø1400 / 4-5-6 Blade

Ø1400 / 5-6-10 Blade

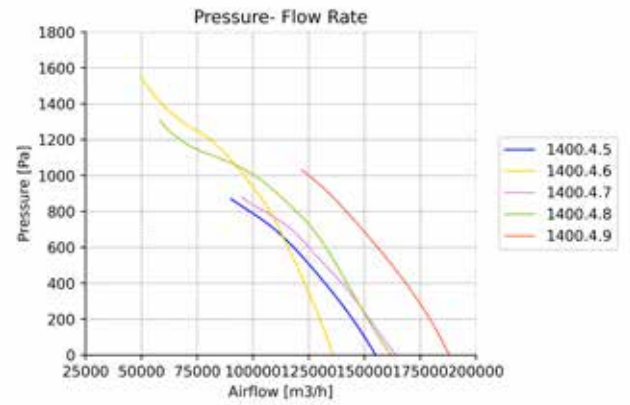
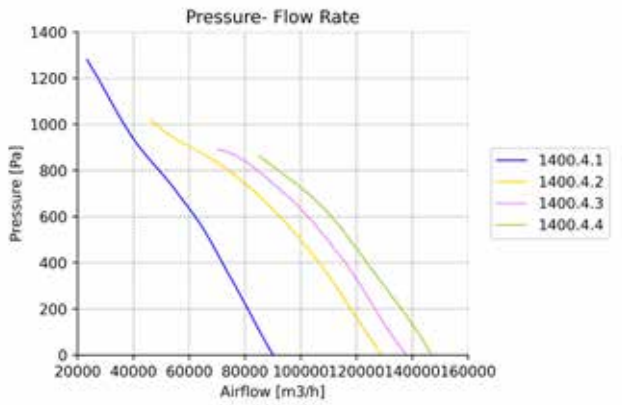

PRODUCT DIMENSIONS

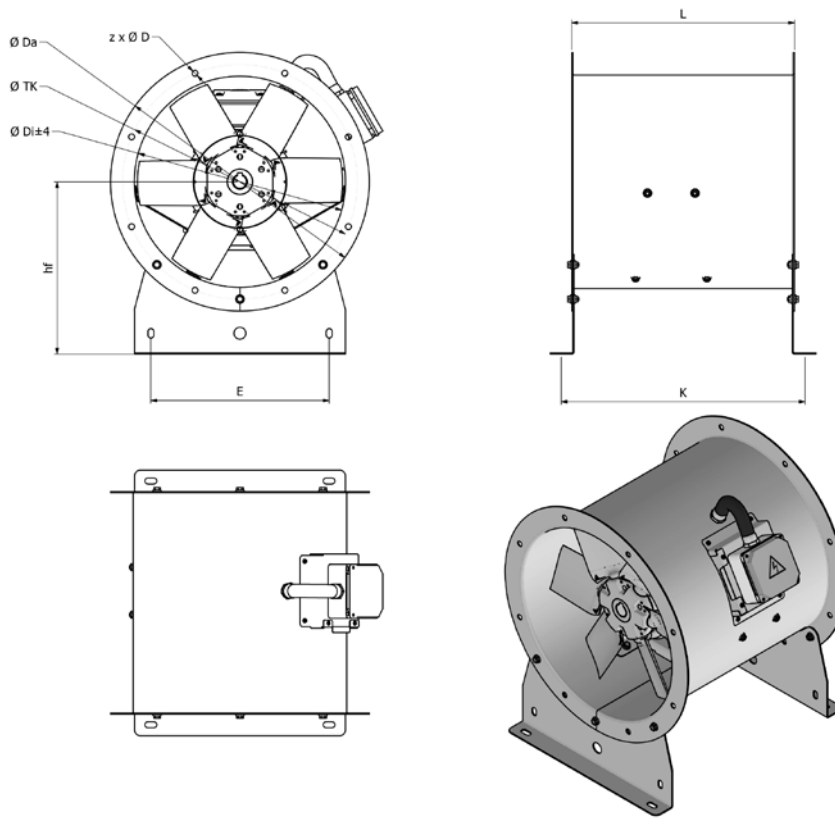

$\varnothing Di$	2 Poles	4 Poles	$\varnothing TK$	$\varnothing Da$	$z \times \varnothing D$	L	E	K	hf
315	0,37--0,55	0,37	355	395	8 x 10	375	260	410	270
315	0,75--1,1	0,55--0,75	355	395	8 x 10	375	260	410	270
355	0,37--0,55	0,37	395	435	8 x 10	400	300	435	290
355	0,75--1,1	0,55--0,75	395	435	8 x 10	400	300	435	290
355	1,5--2,2	1,1--1,5	395	435	8 x 10	400	300	435	290
400	0,75--1,1	0,55--0,75	450	480	8 x 12	400	345	435	315
400	1,5--2,2	1,1--1,5	450	480	8 x 12	520	345	555	315
400	3	2,2--3	450	480	8 x 12	520	345	555	315
450	0,37--0,55	0,37	500	530	8 x 12	450	395	485	340
450	0,75--1,1	0,55--0,75	500	530	8 x 12	450	395	485	340
450	1,5--2,2	1,1--1,5	500	530	8 x 12	570	395	605	340
450	3	2,2--3	500	530	8 x 12	570	395	605	340
450	4	4	500	530	8 x 12	640	395	675	340
450	5,5--7,5	5,5--7,5	500	530	8 x 12	640	395	675	340
500	0,37--0,55	0,37	560	590	12 x 12	450	440	490	390
500	0,75--1,1	0,55--0,75	560	590	12 x 12	450	440	490	390
500	1,5--2,2	1,1--1,5	560	590	12 x 12	570	440	610	390
500	3	2,2--3	560	590	12 x 12	570	440	610	390
500	4	4	560	590	12 x 12	640	440	680	390
500	5,5--7,5	5,5--7,5	560	590	12 x 12	640	440	680	390

ØDi	2 Poles	4 Poles	ØTK	ØDa	z x ØD	L	E	K	hf
560	0,37--0,55	0,37	620	650	12 x 12	570	500	610	420
560	0,75--1,1	0,55--0,75	620	650	12 x 12	570	500	610	420
560	1,5--2,2	1,1--1,5	620	650	12 x 12	570	500	610	420
560	3	2,2--3	620	650	12 x 12	570	500	610	420
560	4	4	620	650	12 x 12	640	500	680	420
560	5,5--7,5	5,5--7,5	620	650	12 x 12	640	500	680	420
560	15--18,5	11--15	620	650	12 x 12	750	500	790	420
630	0,37--0,55	0,37	690	720	12 x 12	570	570	610	455
630	0,75--1,1	0,55--0,75	690	720	12 x 12	570	570	610	455
630	1,5--2,2	1,1--1,5	690	720	12 x 12	570	570	610	455
630	3	2,2--3	690	720	12 x 12	570	570	610	455
630	4	4	690	720	12 x 12	640	570	680	455
630	5,5--7,5	5,5--7,5	690	720	12 x 12	640	570	680	455
630	15--18,5	11--15	690	720	12 x 12	750	570	790	455
710	0,75--1,1	0,55--0,75	770	800	16 x 12	570	650	620	525
710	1,5--2,2	1,1--1,5	770	800	16 x 12	570	650	620	525
710	3	2,2--3	770	800	16 x 12	570	650	620	525
710	4	4	770	800	16 x 12	640	650	690	525
710	5,5--7,5	5,5--7,5	770	800	16 x 12	640	650	690	525
710	15--18,5	11--15	770	800	16 x 12	850	650	900	525
710	22	18,5--22	770	800	16 x 12	850	650	900	525
710	30--37	30--37	770	800	16 x 12	850	650	900	525
800	0,75--1,1	0,55--0,75	860	890	16 x 12	570	730	620	570
800	1,5--2,2	1,1--1,5	860	890	16 x 12	570	730	620	570
800	3	2,2--3	860	890	16 x 12	570	730	620	570
800	4	4	860	890	16 x 12	700	730	750	570
800	5,5--7,5	5,5--7,5	860	890	16 x 12	700	730	750	570
800	15--18,5	11--15	860	890	16 x 12	850	730	900	570
800	22	18,5--22	860	890	16 x 12	850	730	900	570
800	30--37	30--37	860	890	16 x 12	850	730	900	570
900	-	0,55--0,75	970	1005	16 x 15	570	830	620	620
900	-	1,1--1,5	970	1005	16 x 15	570	830	620	620
900	-	2,2--3	970	1005	16 x 15	570	830	620	620
900	-	4	970	1005	16 x 15	700	830	750	620
900	-	5,5--7,5	970	1005	16 x 15	700	830	750	620
900	-	11--15	970	1005	16 x 15	850	830	900	620
900	-	18,5--22	970	1005	16 x 15	850	830	900	620
900	-	30--37	970	1005	16 x 15	850	830	900	620
1000	-	0,55--0,75	1070	1105	16 x 15	570	930	620	670
1000	-	1,1--1,5	1070	1105	16 x 15	570	930	620	670
1000	-	2,2--3	1070	1105	16 x 15	570	930	620	670
1000	-	4	1070	1105	16 x 15	700	930	750	670
1000	-	5,5--7,5	1070	1105	16 x 15	700	930	750	670

ØDi	2 Poles	4 Poles	ØTK	ØDa	z x ØD	L	E	K	hf
1000	-	11--15	1070	1105	16 x 15	950	930	1000	670
1000	-	18,5--22	1070	1105	16 x 15	950	930	1000	670
1000	-	30--37	1070	1105	16 x 15	950	930	1000	670
1000	-	45--55	1070	1105	16 x 15	950	930	1000	670
1120	-	4	1190	1260	20 x 15	750	1020	812	764
1120	-	5,5--7,5	1190	1260	20 x 15	750	1020	812	764
1120	-	11--15	1190	1260	20 x 15	800	1020	862	764
1120	-	18,5--22	1190	1260	20 x 15	800	1020	862	764
1120	-	30--37	1190	1260	20 x 15	950	1020	1012	764
1120	-	45--55	1190	1260	20 x 15	950	1020	1012	764
1250	-	4	1320	1390	20 x 15	700	1150	760	825
1250	-	5,5--7,5	1320	1390	20 x 15	700	1150	760	825
1250	-	11--15	1320	1390	20 x 15	800	1150	860	825
1250	-	18,5--22	1320	1390	20 x 15	800	1150	860	825
1250	-	30--37	1320	1390	20 x 15	1000	1150	1060	825
1250	-	45--55	1320	1390	20 x 15	1000	1150	1060	825
1250	-	75	1320	1390	20 x 15	1000	1150	1060	825
1400	-	5,5--7,5	1470	1540	20 x 15	750	1300	810	900
1400	-	11--15	1470	1540	20 x 15	900	1300	960	900
1400	-	18,5--22	1470	1540	20 x 15	900	1300	960	900
1400	-	30--37	1470	1540	20 x 15	1120	1300	1180	900
1400	-	45--55	1470	1540	20 x 15	1120	1300	1180	900
1400	-	75	1470	1540	20 x 15	1120	1300	1180	900
1400	-	90	1470	1540	20 x 15	1120	1300	1180	900

TECHNICAL PARAMETERS

MODEL	MODEL NUMBER	Voltage Frequency	Motor Power	Current	Rotation Speed	Sound Pressure	Protection Class	Working Range	Mass
		V-Hz	kW	A	RPM	Lp(A) dB at 3m	IP	°C	~ Kg
MARLIN 315P1U-2T0,37	315.2.1	400-50	0,37	1,5	2880	59,1	55	-20/+50	17
MARLIN 315P2U-2T0,37	315.2.2	400-50	0,37	1,5	2880	62,3	55	-20/+50	17
MARLIN 315P3U-2T0,37	315.2.3	400-50	0,37	1,5	2880	62	55	-20/+50	17
MARLIN 315P4U-2T0,37	315.2.4	400-50	0,37	1,5	2880	64	55	-20/+50	17
MARLIN 315P5U-2T0,55	315.2.5	400-50	0,55	1,6	2880	65,3	55	-20/+50	18
MARLIN 315P6U-2T0,55	315.2.6	400-50	0,55	1,6	2880	65,3	55	-20/+50	18
MARLIN 315P7U-2T0,37	315.2.7	400-50	0,37	1,5	2880	64,1	55	-20/+50	17
MARLIN 315P8U-2T0,37	315.2.8	400-50	0,37	1,5	2880	65,1	55	-20/+50	17
MARLIN 315P9U-2T0,55	315.2.9	400-50	0,55	1,6	2880	61,1	55	-20/+50	18
MARLIN 315P10U-2T0,55	315.2.10	400-50	0,55	1,6	2880	61,6	55	-20/+50	18
MARLIN 315P11U-2T0,75	315.2.11	400-50	0,75	1,7	2880	62,9	55	-20/+50	20
MARLIN 315P12U-2T1,1	315.2.12	400-50	1,1	2,3	2880	64,1	55	-20/+50	21
MARLIN 355P1U-2T0,37	355.2.1	400-50	0,37	1,5	2880	60,1	55	-20/+50	19
MARLIN 355P2U-2T0,37	355.2.2	400-50	0,37	1,5	2880	58,2	55	-20/+50	19
MARLIN 355P3U-2T0,55	355.2.3	400-50	0,55	1,6	2880	60,9	55	-20/+50	20
MARLIN 355P4U-2T0,55	355.2.4	400-50	0,55	1,6	2880	62,2	55	-20/+50	20
MARLIN 355P5U-2T0,75	355.2.5	400-50	0,75	1,7	2880	64,1	55	-20/+50	22
MARLIN 355P6U-2T0,55	355.2.6	400-50	0,55	1,6	2880	62,6	55	-20/+50	20
MARLIN 355P7U-2T0,55	355.2.7	400-50	0,55	1,6	2880	65,9	55	-20/+50	20
MARLIN 355P8U-2T0,75	355.2.8	400-50	0,75	1,7	2880	61,5	55	-20/+50	22
MARLIN 355P9U-2T0,75	355.2.9	400-50	0,75	1,7	2880	62,1	55	-20/+50	22
MARLIN 355P10U-2T1,1	355.2.10	400-50	1,1	2,3	2880	62,4	55	-20/+50	23
MARLIN 355P11U-2T0,75	355.2.11	400-50	0,75	1,7	2880	63,2	55	-20/+50	22
MARLIN 355P12U-2T1,5	355.2.12	400-50	1,5	3,3	2880	65,8	55	-20/+50	26
MARLIN 400P1U-2T0,37	400.2.1	400-50	0,37	1,5	2880	64,5	55	-20/+50	21
MARLIN 400P2U-2T0,55	400.2.2	400-50	0,55	1,6	2880	62,5	55	-20/+50	22
MARLIN 400P3U-2T0,75	400.2.3	400-50	0,75	1,7	2880	63,8	55	-20/+50	24
MARLIN 400P4U-2T0,75	400.2.4	400-50	0,75	1,7	2880	64,6	55	-20/+50	24
MARLIN 400P5U-2T1,1	400.2.5	400-50	1,1	2,3	2880	67,2	55	-20/+50	27
MARLIN 400P6U-2T1,1	400.2.6	400-50	1,1	2,3	2880	64,5	55	-20/+50	27
MARLIN 400P7U-2T1,5	400.2.7	400-50	1,5	3,3	2880	67	55	-20/+50	30
MARLIN 400P8U-2T2,2	400.2.8	400-50	2,2	4,5	2880	69,4	55	-20/+50	32
MARLIN 400P9U-2T0,75	400.2.9	400-50	0,75	1,7	2880	67,6	55	-20/+50	24
MARLIN 400P10U-2T0,75	400.2.10	400-50	0,75	1,7	2880	65,6	55	-20/+50	24
MARLIN 400P11U-2T1,1	400.2.11	400-50	1,1	2,3	2880	64,2	55	-20/+50	27
MARLIN 400P12U-2T1,5	400.2.12	400-50	1,5	3,3	2880	65,4	55	-20/+50	30
MARLIN 400P13U-2T1,5	400.2.13	400-50	1,5	3,3	2880	65,2	55	-20/+50	30
MARLIN 400P14U-2T2,2	400.2.14	400-50	2,2	4,5	2880	65,5	55	-20/+50	32
MARLIN 400P15U-2T3	400.2.15	400-50	3	5,9	2880	68,3	55	-20/+50	39
MARLIN 450P1U-2T0,55	450.2.1	400-50	0,55	1,6	2880	68	55	-20/+50	25
MARLIN 450P2U-2T0,75	450.2.2	400-50	0,75	1,7	2880	71,9	55	-20/+50	27
MARLIN 450P3U-2T1,1	450.2.3	400-50	1,1	2,3	2880	66,9	55	-20/+50	31
MARLIN 450P4U-2T1,1	450.2.4	400-50	1,1	2,3	2880	68,3	55	-20/+50	31
MARLIN 450P5U-2T1,1	450.2.5	400-50	1,1	2,3	2880	72	55	-20/+50	31
MARLIN 450P6U-2T1,5	450.2.6	400-50	1,5	3,3	2880	66,3	55	-20/+50	34

MODEL	MODEL NUMBER	Voltage Frequency	Motor Power	Current	Rotation Speed	Sound Pressure	Protection Class	Working Range	Mass
		V-Hz	kW	A	RPM	Lp(A) dB at 3m	IP	°C	~ Kg
MARLIN 450P7U-2T2,2	450.2.7	400-50	2,2	4,5	2880	69,4	55	-20/+50	36
MARLIN 450P8U-2T1,5	450.2.8	400-50	1,5	3,3	2880	71,3	55	-20/+50	34
MARLIN 450P9U-2T2,2	450.2.9	400-50	2,2	4,5	2880	69,6	55	-20/+50	36
MARLIN 450P10U-2T2,2	450.2.10	400-50	2,2	4,5	2880	68,9	55	-20/+50	36
MARLIN 450P11U-2T3	450.2.11	400-50	3	5,9	2880	70	55	-20/+50	43
MARLIN 450P12U-2T4	450.2.12	400-50	4	7,9	2880	73,2	55	-20/+50	45
MARLIN 450P13U-2T3	450.2.13	400-50	3	5,9	2880	68,4	55	-20/+50	43
MARLIN 450P14U-2T3	450.2.14	400-50	3	5,9	2880	68,4	55	-20/+50	43
MARLIN 450P15U-2T5,5	450.2.15	400-50	5,5	10,3	2880	69,7	55	-20/+50	61
MARLIN 500P1U-2T0,75	500.2.1	400-50	0,75	1,7	2880	75,3	55	-20/+50	40
MARLIN 500P2U-2T1,1	500.2.2	400-50	1,1	2,3	2880	69,8	55	-20/+50	45
MARLIN 500P3U-2T1,5	500.2.3	400-50	1,5	3,3	2880	71,2	55	-20/+50	48
MARLIN 500P4U-2T2,2	500.2.4	400-50	2,2	4,5	2880	69,4	55	-20/+50	50
MARLIN 500P5U-2T2,2	500.2.6	400-50	2,2	4,5	2880	68,9	55	-20/+50	50
MARLIN 500P6U-2T2,2	500.2.5	400-50	2,2	4,5	2880	65,8	55	-20/+50	50
MARLIN 500P7U-2T3	500.2.7	400-50	3	5,9	2880	69,4	55	-20/+50	57
MARLIN 500P8U-2T3	500.2.8	400-50	3	5,9	2880	73	55	-20/+50	57
MARLIN 500P9U-2T4	500.2.9	400-50	4	7,9	2880	73,5	55	-20/+50	60
MARLIN 500P10U-2T4	500.2.10	400-50	4	7,9	2880	71,2	55	-20/+50	60
MARLIN 500P11U-2T5,5	500.2.11	400-50	5,5	10,3	2880	70,9	55	-20/+50	76
MARLIN 500P12U-2T7,5	500.2.12	400-50	7,5	13,6	2880	71,7	55	-20/+50	83
MARLIN 500P13U-2T7,5	500.2.13	400-50	7,5	13,6	2880	71,7	55	-20/+50	83
MARLIN 560P1U-2T0,75	560.2.1	400-50	0,75	1,7	2880	71,7	55	-20/+50	49
MARLIN 560P2U-2T1,1	560.2.2	400-50	1,1	2,3	2880	69,4	55	-20/+50	49
MARLIN 560P3U-2T1,5	560.2.3	400-50	1,5	3,3	2880	72,7	55	-20/+50	52
MARLIN 560P4U-2T2,2	560.2.4	400-50	3	5,9	2880	73	55	-20/+50	55
MARLIN 560P5U-2T4	560.2.5	400-50	4	7,9	2880	71,7	55	-20/+50	65
MARLIN 560P6U-2T4	560.2.6	400-50	4	7,9	2880	72,8	55	-20/+50	65
MARLIN 560P7U-2T5,5	560.2.7	400-50	5,5	10,3	2880	74,6	55	-20/+50	80
MARLIN 560P8U-2T3	560.2.8	400-50	3	5,9	2880	71,7	55	-20/+50	62
MARLIN 560P9U-2T4	560.2.9	400-50	4	7,9	2880	72,2	55	-20/+50	65
MARLIN 560P10U-2T5,5	560.2.10	400-50	5,5	10,3	2880	72,5	55	-20/+50	80
MARLIN 560P11U-2T7,5	560.2.11	400-50	7,5	13,6	2880	74,3	55	-20/+50	87
MARLIN 560P12U-2T4	560.2.12	400-50	4	7,9	2880	73,3	55	-20/+50	65
MARLIN 560P13U-2T5,5	560.2.13	400-50	5,5	10,3	2880	74,7	55	-20/+50	80
MARLIN 560P14U-2T7,5	560.2.14	400-50	7,5	13,6	2880	73,4	55	-20/+50	87
MARLIN 560P15U-2T11	560.2.15	400-50	11	19,5	2880	74,1	55	-20/+50	116
MARLIN 560P16U-2T11	560.2.16	400-50	11	19,5	2880	73,8	55	-20/+50	116
MARLIN 630P1U-2T2,2	630.2.1	400-50	2,2	4,5	2880	72,7	55	-20/+50	59
MARLIN 630P2U-2T3	630.2.2	400-50	3	5,9	2880	73,8	55	-20/+50	66
MARLIN 630P3U-2T5,5	630.2.3	400-50	5,5	10,3	2880	72,2	55	-20/+50	85
MARLIN 630P4U-2T5,5	630.2.4	400-50	5,5	10,3	2880	74,3	55	-20/+50	85
MARLIN 630P5U-2T7,5	630.2.5	400-50	7,5	13,6	2880	77,5	55	-20/+50	92
MARLIN 630P6U-2T7,5	630.2.6	400-50	7,5	13,6	2880	75,4	55	-20/+50	92
MARLIN 630P7U-2T11	630.2.7	400-50	11	19,5	2880	77,7	55	-20/+50	121
MARLIN 630P8U-2T11	630.2.8	400-50	11	19,5	2880	75,7	55	-20/+50	121

MODEL	MODEL NUMBER	Voltage Frequency	Motor Power	Current	Rotation Speed	Sound Pressure	Protection Class	Working Range	Mass
		V-Hz	kW	A	RPM	Lp(A) dB at 3m	IP	°C	~ Kg
MARLIN 630P9U-2T7,5	630.2.9	400-50	7,5	13,6	2880	77,4	55	-20/+50	92
MARLIN 630P10U-2T11	630.2.10	400-50	11	19,5	2880	75,6	55	-20/+50	121
MARLIN 630P11U-2T11	630.2.11	400-50	11	19,5	2880	75,7	55	-20/+50	121
MARLIN 630P12U-2T15	630.2.12	400-50	15	28,3	2880	75,6	55	-20/+50	135
MARLIN 630P13U-2T15	630.2.13	400-50	15	28,3	2880	77,7	55	-20/+50	135
MARLIN 630P14U-2T15	630.2.14	400-50	15	28,3	2880	75,5	55	-20/+50	135
MARLIN 710P1U-2T3	710.2.1	400-50	3	5,9	2880	78,8	55	-20/+50	73
MARLIN 710P2U-2T5,5	710.2.2	400-50	5,5	10,3	2880	76	55	-20/+50	92
MARLIN 710P3U-2T7,5	710.2.3	400-50	7,5	13,6	2880	76,3	55	-20/+50	99
MARLIN 710P4U-2T7,5	710.2.4	400-50	7,5	13,6	2880	77,1	55	-20/+50	99
MARLIN 710P5U-2T11	710.2.5	400-50	11	19,5	2880	77,9	55	-20/+50	136
MARLIN 710P6U-2T11	710.2.6	400-50	11	19,5	2880	78,9	55	-20/+50	136
MARLIN 710P7U-2T5,5	710.2.7	400-50	5,5	10,3	2880	86,5	55	-20/+50	92
MARLIN 710P8.AU-2T7,5	710.2.8A	400-50	7,5	13,6	2880	82,5	55	-20/+50	99
MARLIN 710P8.BU-2T11	710.2.8B	400-50	11	19,5	2880	82,5	55	-20/+50	136
MARLIN 710P9U-2T15	710.2.9	400-50	15	28,3	2880	75,4	55	-20/+50	150
MARLIN 710P10U-2T11	710.2.10	400-50	11	19,5	2880	80,5	55	-20/+50	136
MARLIN 710P11U-2T15	710.2.11	400-50	15	28,3	2880	77,3	55	-20/+50	150
MARLIN 710P12U-2T15	710.2.12	400-50	15	28,3	2880	80,5	55	-20/+50	150
MARLIN 710P13U-2T18,5	710.2.13	400-50	18,5	32,3	2880	81,5	55	-20/+50	172
MARLIN 710P14U-2T18,5	710.2.14	400-50	18,5	32,3	2880	81,5	55	-20/+50	172
MARLIN 800P1U-2T11	800.2.1	400-50	11	19,5	2880	81,5	55	-20/+50	145
MARLIN 800P2U-2T15	800.2.2	400-50	15	28,3	2880	82,5	55	-20/+50	159
MARLIN 800P3U-2T18,5	800.2.3	400-50	18,5	32,3	2880	84,5	55	-20/+50	181
MARLIN 800P4U-2T22	800.2.4	400-50	22	38,3	2880	85,5	55	-20/+50	213
MARLIN 800P5U-2T18,5	800.2.5	400-50	18,5	32,3	2880	85,5	55	-20/+50	181
MARLIN 800P6U-2T18,5	800.2.6	400-50	18,5	32,3	2880	85,5	55	-20/+50	181
MARLIN 800P7U-2T22	800.2.7	400-50	22	38,3	2880	85,5	55	-20/+50	213
MARLIN 315P1U-4T0,37	315.4.1	400-50	0,37	1,13	1440	49,1	55	-20/+50	19
MARLIN 315P2U-4T0,37	315.4.2	400-50	0,37	1,13	1440	49,2	55	-20/+50	19
MARLIN 355P1U-4T0,37	355.4.1	400-50	0,37	1,13	1440	46,5	55	-20/+50	21
MARLIN 355P2U-4T0,37	355.4.2	400-50	0,37	1,13	1440	48,1	55	-20/+50	21
MARLIN 400P1U-4T0,37	400.4.1	400-50	0,37	1,13	1440	50,5	55	-20/+50	23
MARLIN 400P2U-4T0,37	400.4.2	400-50	0,37	1,13	1440	50,7	55	-20/+50	23
MARLIN 400P3U-4T0,37	400.4.3	400-50	0,37	1,13	1440	51,6	55	-20/+50	23
MARLIN 450P1U-4T0,37	450.4.1	400-50	0,37	1,13	1440	52,7	55	-20/+50	26
MARLIN 450P2U-4T0,37	450.4.2	400-50	0,37	1,13	1440	54,6	55	-20/+50	27
MARLIN 450P3U-4T0,37	450.4.3	400-50	0,37	1,13	1440	54,7	55	-20/+50	26
MARLIN 450P4U-4T0,55	450.4.4	400-50	0,55	1,55	1440	53,4	55	-20/+50	27
MARLIN 450P5U-4T0,37	450.4.5	400-50	0,37	1,13	1440	53,4	55	-20/+50	27
MARLIN 450P6U-4T0,55	450.4.6	400-50	0,55	1,55	1440	53,4	55	-20/+50	27
MARLIN 450P7U-4T0,75	450.4.7	400-50	0,75	2	1440	53,5	55	-20/+50	31
MARLIN 500P1U-4T0,37	500.4.1	400-50	0,37	1,13	1440	51,7	55	-20/+50	39
MARLIN 500P2U-4T0,55	500.4.2	400-50	0,55	1,55	1440	56,5	55	-20/+50	39
MARLIN 500P3U-4T0,37	500.4.3	400-50	0,37	1,13	1440	57,6	55	-20/+50	39
MARLIN 500P4U-4T0,75	500.4.4	400-50	0,75	2	1440	56,8	55	-20/+50	43

MODEL	MODEL NUMBER	Voltage Frequency	Motor Power	Current	Rotation Speed	Sound Pressure	Protection Class	Working Range	Mass
		V-Hz	kW	A	RPM	Lp(A) dB at 3m	IP	°C	~ Kg
MARLIN 500P5U-4T0,55	500.4.5	400-50	0,55	1,55	1440	57,8	55	-20/+50	40
MARLIN 500P6U-4T0,75	500.4.6	400-50	0,75	2	1440	57,8	55	-20/+50	44
MARLIN 500P7U-4T1,1	500.4.7	400-50	1,1	2,6	1440	58,5	55	-20/+50	51
MARLIN 560P1U-4T0,37	560.4.1	400-50	0,37	1,13	1440	58,6	55	-20/+50	47
MARLIN 560P2U-4T0,55	560.4.2	400-50	0,55	1,55	1440	58,2	55	-20/+50	48
MARLIN 560P3U-4T0,75	560.4.3	400-50	0,75	2	1440	59,5	55	-20/+50	52
MARLIN 560P4U-4T0,75	560.4.4	400-50	0,75	2	1440	60	55	-20/+50	52
MARLIN 560P5U-4T1,1	560.4.5	400-50	1,1	2,6	1440	59,7	55	-20/+50	54
MARLIN 560P6U-4T0,37	560.4.6	400-50	0,37	1,13	1440	60,3	55	-20/+50	49
MARLIN 560P7U-4T0,75	560.4.7	400-50	0,75	2	1440	59,8	55	-20/+50	53
MARLIN 560P8U-4T1,1	560.4.8	400-50	1,1	2,6	1440	58,8	55	-20/+50	55
MARLIN 560P9U-4T1,1	560.4.9	400-50	1,1	2,6	1440	59,3	55	-20/+50	55
MARLIN 560P10U-4T1,5	560.4.10	400-50	1,5	3,5	1440	60,2	55	-20/+50	58
MARLIN 630P1U-4T0,55	630.4.1	400-50	0,55	1,55	1440	60,4	55	-20/+50	53
MARLIN 630P2U-4T0,55	630.4.2	400-50	0,55	1,55	1440	60	55	-20/+50	53
MARLIN 630P3U-4T0,75	630.4.3	400-50	0,75	2	1440	58,2	55	-20/+50	57
MARLIN 630P4U-4T1,1	630.4.4	400-50	1,1	2,6	1440	61,6	55	-20/+50	59
MARLIN 630P5U-4T1,5	630.4.5	400-50	1,5	3,5	1440	62,4	55	-20/+50	62
MARLIN 630P6U-4T0,75	630.4.6	400-50	0,75	2	1440	61,2	55	-20/+50	57
MARLIN 630P7U-4T2,2	630.4.7	400-50	2,2	5	1440	65,1	55	-20/+50	64
MARLIN 630P8U-4T0,75	630.4.8	400-50	0,75	2	1440	61,8	55	-20/+50	57
MARLIN 630P9U-4T0,75	630.4.9	400-50	0,75	2	1440	67	55	-20/+50	57
MARLIN 630P10U-4T1,1	630.4.10	400-50	1,1	2,6	1440	60,5	55	-20/+50	60
MARLIN 630P11U-4T1,5	630.4.11	400-50	1,5	3,5	1440	60,4	55	-20/+50	63
MARLIN 630P12U-4T1,5	630.4.12	400-50	1,5	3,5	1440	61	55	-20/+50	63
MARLIN 630P13U-4T2,2	630.4.13	400-50	2,2	5	1440	62	55	-20/+50	65
MARLIN 630P14U-4T2,2	630.4.14	400-50	2,2	5	1440	62,1	55	-20/+50	65
MARLIN 630P15U-4T1,5	630.4.15	400-50	1,5	3,5	1440	65,3	55	-20/+50	63
MARLIN 630P16U-4T2,2	630.4.16	400-50	2,2	5	1440	65,2	55	-20/+50	65
MARLIN 630P17U-4T2,2	630.4.17	400-50	2,2	5	1440	65,1	55	-20/+50	65
MARLIN 630P18U-4T2,2	630.4.18	400-50	2,2	5	1440	65,4	55	-20/+50	65
MARLIN 630P19U-4T3	630.4.19	400-50	3	6,6	1440	66,8	55	-20/+50	72
MARLIN 710P1U-4T0,75	710.4.1	400-50	0,75	2	1440	65,8	55	-20/+50	64
MARLIN 710P2U-4T1,5	710.4.2	400-50	1,5	3,5	1440	63	55	-20/+50	69
MARLIN 710P3U-4T1,5	710.4.3	400-50	1,5	3,5	1440	65,9	55	-20/+50	69
MARLIN 710P4U-4T2,2	710.4.4	400-50	2,2	5	1440	66	55	-20/+50	71
MARLIN 710P5U-4T3	710.4.5	400-50	3	6,6	1440	66,8	55	-20/+50	77
MARLIN 710P6U-4T3	710.4.6	400-50	3	6,6	1440	67,5	55	-20/+50	77
MARLIN 710P7U-4T3	710.4.7	400-50	3	6,6	1440	68,1	55	-20/+50	78
MARLIN 710P8U-4T1,5	710.4.8	400-50	1,5	3,5	1440	63,8	55	-20/+50	71
MARLIN 710P9U-4T2,2	710.4.9	400-50	2,2	5	1440	62,2	55	-20/+50	73
MARLIN 710P10U-4T2,2	710.4.10	400-50	2,2	5	1440	67,8	55	-20/+50	72
MARLIN 710P11U-4T3	710.4.11	400-50	3	6,6	1440	67	55	-20/+50	79
MARLIN 710P12U-4T4	710.4.12	400-50	4	8,4	1440	67,5	55	-20/+50	88
MARLIN 710P13U-4T4	710.4.13	400-50	4	8,4	1440	66,5	55	-20/+50	87
MARLIN 710P14U-4T5,5	710.4.14	400-50	5,5	11,2	1440	67,5	55	-20/+50	98

MODEL	MODEL NUMBER	Voltage Frequency	Motor Power	Current	Rotation Speed	Sound Pressure	Protection Class	Working Range	Mass
		V-Hz	kW	A	RPM	Lp(A) dB at 3m	IP	°C	~ Kg
MARLIN 800P1U-4T2,2	800.4.1	400-50	2,2	5	1440	70,8	55	-20/+50	79
MARLIN 800P2U-4T3	800.4.2	400-50	3	6,6	1440	69	55	-20/+50	85
MARLIN 800P3U-4T3	800.4.3	400-50	3	6,6	1440	68,1	55	-20/+50	85
MARLIN 800P4U-4T4	800.4.4	400-50	4	8,4	1440	69,1	55	-20/+50	99
MARLIN 800P5U-4T4	800.4.5	400-50	4	8,4	1440	69,3	55	-20/+50	99
MARLIN 800P6U-4T4	800.4.6	400-50	4	8,4	1440	68,6	55	-20/+50	98
MARLIN 800P7U-4T5,5	800.4.7	400-50	5,5	11,2	1440	70,1	55	-20/+50	110
MARLIN 800P8U-4T5,5	800.4.8	400-50	5,5	11,2	1440	70,8	55	-20/+50	109
MARLIN 800P9U-4T1,5	800.4.9	400-50	1,5	3,5	1440	73,2	55	-20/+50	77
MARLIN 800P10U-4T3	800.4.10	400-50	3	6,6	1440	72,1	55	-20/+50	86
MARLIN 800P11U-4T4	800.4.11	400-50	4	8,4	1440	70,7	55	-20/+50	99
MARLIN 800P12U-4T5,5	800.4.12	400-50	5,5	11,2	1440	69,7	55	-20/+50	110
MARLIN 800P13U-4T7,5	800.4.13	400-50	7,5	15,4	1440	70,7	55	-20/+50	117
MARLIN 800P14U-4T2,2	800.4.14	400-50	2,2	5	1440	72,3	55	-20/+50	80
MARLIN 800P15U-4T11	800.4.15	400-50	11	21,3	1440	71,1	55	-20/+50	168
MARLIN 800P16U-4T7,5	800.4.16	400-50	7,5	15,4	1440	70,9	55	-20/+50	118
MARLIN 800P17U-4T11	800.4.17	400-50	11	21,3	1440	71,4	55	-20/+50	168
MARLIN 800P18U-4T4	800.4.18	400-50	4	8,4	1440	71,8	55	-20/+50	106
MARLIN 800P19U-4T4	800.4.19	400-50	4	8,4	1440	72	55	-20/+50	106
MARLIN 800P20U-4T5,5	800.4.20	400-50	5,5	11,2	1440	71,5	55	-20/+50	117
MARLIN 800P21U-4T5,5	800.4.21	400-50	5,5	11,2	1440	70,9	55	-20/+50	117
MARLIN 900P1U-4T5,5	900.4.1	400-50	5,5	11,2	1440	76,7	55	-20/+50	119
MARLIN 900P2U-4T7,5	900.4.2	400-50	7,5	15,4	1440	70,5	55	-20/+50	126
MARLIN 900P3U-4T4	900.4.3	400-50	4	8,4	1440	70,3	55	-20/+50	109
MARLIN 900P4U-4T5,5	900.4.4	400-50	5,5	11,2	1440	70,4	55	-20/+50	120
MARLIN 900P5U-4T4	900.4.5	400-50	4	8,4	1440	73,9	55	-20/+50	109
MARLIN 900P6U-4T5,5	900.4.6	400-50	5,5	11,2	1440	73,1	55	-20/+50	120
MARLIN 900P7U-4T7,5	900.4.7	400-50	7,5	15,4	1440	73,2	55	-20/+50	127
MARLIN 900P8U-4T7,5	900.4.8	400-50	7,5	15,4	1440	71,7	55	-20/+50	127
MARLIN 900P9U-4T7,5	900.4.9	400-50	7,5	15,4	1440	72,5	55	-20/+50	127
MARLIN 900P10U-4T7,5	900.4.10	400-50	7,5	15,4	1440	73,2	55	-20/+50	127
MARLIN 900P11U-4T11	900.4.11	400-50	11	21,3	1440	72,8	55	-20/+50	178
MARLIN 900P12U-4T11	900.4.12	400-50	11	21,3	1440	72,9	55	-20/+50	178
MARLIN 900P13U-4T15	900.4.13	400-50	15	29,8	1440	72	55	-20/+50	198
MARLIN 900P14U-4T7,5	900.4.14	400-50	7,5	15,4	1440	73,1	55	-20/+50	128
MARLIN 900P15U-4T7,5	900.4.15	400-50	7,5	15,4	1440	75,9	55	-20/+50	128
MARLIN 900P16U-4T11	900.4.16	400-50	11	21,3	1440	77,8	55	-20/+50	179
MARLIN 900P17U-4T15	900.4.17	400-50	15	29,8	1440	73,7	55	-20/+50	200
MARLIN 900P18U-4T15	900.4.18	400-50	15	29,8	1440	73,5	55	-20/+50	200
MARLIN 900P19U-4T15	900.4.19	400-50	15	29,8	1440	74,3	55	-20/+50	200
MARLIN 900P20U-4T11	900.4.20	400-50	11	21,3	1440	73,4	55	-20/+50	184
MARLIN 900P21U-4T11	900.4.21	400-50	11	21,3	1440	73,4	55	-20/+50	184
MARLIN 900P22U-4T15	900.4.22	400-50	15	29,8	1440	71,6	55	-20/+50	204
MARLIN 1000P1U-4T3	1000.4.1	400-50	3	6,6	1440	70,1	55	-20/+50	123
MARLIN 1000P2U-4T3	1000.4.2	400-50	3	6,6	1440	71	55	-20/+50	123
MARLIN 1000P3U-4T4	1000.4.3	400-50	4	8,4	1440	71,7	55	-20/+50	141

MODEL	MODEL NUMBER	Voltage Frequency	Motor Power	Current	Rotation Speed	Sound Pressure	Protection Class	Working Range	Mass
		V-Hz	kW	A	RPM	Lp(A) dB at 3m	IP	°C	~ Kg
MARLIN 1000P4U-4T4	1000.4.4	400-50	4	8,4	1440	72,5	55	-20/+50	141
MARLIN 1000P5U-4T5,5	1000.4.5	400-50	5,5	11,2	1440	72,4	55	-20/+50	158
MARLIN 1000P6U-4T7,5	1000.4.6	400-50	7,5	15,4	1440	75,7	55	-20/+50	165
MARLIN 1000P7U-4T11	1000.4.7	400-50	11	21,3	1440	77,4	55	-20/+50	238
MARLIN 1000P8U-4T5,5	1000.4.8	400-50	5,5	11,2	1440	71,8	55	-20/+50	159
MARLIN 1000P9U-4T7,5	1000.4.9	400-50	7,5	15,4	1440	73,3	55	-20/+50	166
MARLIN 1000P10U-4T5,5	1000.4.10	400-50	5,5	11,2	1440	74,9	55	-20/+50	160
MARLIN 1000P11U-4T7,5	1000.4.11	400-50	7,5	15,4	1440	78	55	-20/+50	167
MARLIN 1000P12U-4T11	1000.4.12	400-50	11	21,3	1440	76	55	-20/+50	238
MARLIN 1000P13U-4T11	1000.4.13	400-50	11	21,3	1440	76,4	55	-20/+50	238
MARLIN 1000P14U-4T15	1000.4.14	400-50	15	29,8	1440	77,8	55	-20/+50	258
MARLIN 1000P15U-4T15	1000.4.15	400-50	15	29,8	1440	78,4	55	-20/+50	258
MARLIN 1000P16U-4T7,5	1000.4.16	400-50	7,5	15,4	1440	75,7	55	-20/+50	160
MARLIN 1000P17U-4T7,5	1000.4.17	400-50	7,5	15,4	1440	75,3	55	-20/+50	160
MARLIN 1000P18U-4T11	1000.4.18	400-50	11	21,3	1440	75,3	55	-20/+50	231
MARLIN 1000P19U-4T11	1000.4.19	400-50	11	21,3	1440	76	55	-20/+50	231
MARLIN 1000P20U-4T11	1000.4.20	400-50	11	21,3	1440	80,5	55	-20/+50	238
MARLIN 1000P21U-4T11	1000.4.21	400-50	11	21,3	1440	80,5	55	-20/+50	238
MARLIN 1000P22U-4T15	1000.4.22	400-50	15	29,8	1440	79,5	55	-20/+50	258
MARLIN 1000P23U-4T15	1000.4.23	400-50	15	29,8	1440	78,4	55	-20/+50	258
MARLIN 1000P24U-4T22	1000.4.24	400-50	22	42,5	1440	79,5	55	-20/+50	313
MARLIN 1000P25.AU-4T11	1000.4.25.A	400-50	11	21,3	1440	73,3	55	-20/+50	242
MARLIN 1000P25.BU-4T15	1000.4.25.B	400-50	15	29,8	1440	73,3	55	-20/+50	262
MARLIN 1000P26U-4T15	1000.4.26	400-50	15	29,8	1440	75	55	-20/+50	262
MARLIN 1000P27U-4T22	1000.4.27	400-50	22	42,5	1440	76,4	55	-20/+50	317
MARLIN 1000P28U-4T30	1000.4.28	400-50	30	55	1440	79,1	55	-20/+50	325
MARLIN 1000P29U-4T22	1000.4.29	400-50	22	42,5	1440	77,5	55	-20/+50	317
MARLIN 1000P30U-4T30	1000.4.30	400-50	30	55	1440	77,8	55	-20/+50	332
MARLIN 1000P31U-4T7,5	1000.4.31	400-50	7,5	15,4	1440	78,8	55	-20/+50	161
MARLIN 1000P32U-4T11	1000.4.32	400-50	11	21,3	1440	75,9	55	-20/+50	232
MARLIN 1000P33U-4T15	1000.4.33	400-50	15	29,8	1440	75,4	55	-20/+50	252
MARLIN 1000P34U-4T22	1000.4.34	400-50	22	42,5	1440	82,5	55	-20/+50	313
MARLIN 1000P35U-4T22	1000.4.35	400-50	22	42,5	1440	82,5	55	-20/+50	313
MARLIN 1000P36U-4T30	1000.4.36	400-50	30	55	1440	81,5	55	-20/+50	328
MARLIN 1000P37U-4T37	1000.4.37	400-50	37	67	1440	80,5	55	-20/+50	428
MARLIN 1120P1U-4T5,5	1120.4.1	400-50	5,5	11,2	1440	75,5	55	-20/+50	184
MARLIN 1120P2U-4T7,5	1120.4.2	400-50	7,5	15,4	1440	76,1	55	-20/+50	191
MARLIN 1120P3U-4T11	1120.4.3	400-50	11	21,3	1440	77,6	55	-20/+50	249
MARLIN 1120P4U-4T11	1120.4.4	400-50	11	21,3	1440	77,8	55	-20/+50	247
MARLIN 1120P5U-4T15	1120.4.5	400-50	15	29,8	1440	79,1	55	-20/+50	269
MARLIN 1120P6U-4T18,5	1120.4.6	400-50	18,5	34,5	1440	80,5	55	-20/+50	309
MARLIN 1120P7U-4T7,5	1120.4.7	400-50	7,5	15,4	1440	77,1	55	-20/+50	193
MARLIN 1120P8U-4T11	1120.4.8	400-50	11	21,3	1440	80,5	55	-20/+50	249
MARLIN 1120P9U-4T11	1120.4.9	400-50	11	21,3	1440	79,5	55	-20/+50	249
MARLIN 1120P10U-4T15	1120.4.10	400-50	15	29,8	1440	78,3	55	-20/+50	269
MARLIN 1120P11U-4T15	1120.4.11	400-50	15	29,8	1440	77,8	55	-20/+50	269

MODEL	MODEL NUMBER	Voltage Frequency	Motor Power	Current	Rotation Speed	Sound Pressure	Protection Class	Working Range	Mass
		V-Hz	kW	A	RPM	Lp(A) dB at 3m	IP	°C	~ Kg
MARLIN 1120P12U-4T18,5	1120.4.12	400-50	18,5	34,5	1440	79,5	55	-20/+50	309
MARLIN 1120P13U-4T22	1120.4.13	400-50	22	42,5	1440	80,5	55	-20/+50	324
MARLIN 1120P14U-4T22	1120.4.14	400-50	22	42,5	1440	81,5	55	-20/+50	324
MARLIN 1120P15U-4T22	1120.4.15	400-50	22	42,5	1440	80,5	55	-20/+50	324
MARLIN 1120P16U-4T11	1120.4.16	400-50	11	21,3	1440	82,5	55	-20/+50	249
MARLIN 1120P17U-4T15	1120.4.17	400-50	15	29,8	1440	82,5	55	-20/+50	269
MARLIN 1120P18U-4T15	1120.4.18	400-50	15	29,8	1440	82,5	55	-20/+50	269
MARLIN 1120P19U-4T22	1120.4.19	400-50	22	42,5	1440	80,5	55	-20/+50	324
MARLIN 1120P20U-4T30	1120.4.20	400-50	30	55	1440	83,5	55	-20/+50	354
MARLIN 1120P21U-4T5,5	1120.4.21	400-50	5,5	11,2	1440	83,5	55	-20/+50	181
MARLIN 1120P22U-4T7,5	1120.4.22	400-50	7,5	15,4	1440	83,5	55	-20/+50	188
MARLIN 1120P23U-4T11	1120.4.23	400-50	11	21,3	1440	79,1	55	-20/+50	244
MARLIN 1120P24U-4T15	1120.4.24	400-50	15	29,8	1440	78,6	55	-20/+50	264
MARLIN 1120P25U-4T18,5	1120.4.25	400-50	18,5	34,5	1440	77,6	55	-20/+50	304
MARLIN 1120P26U-4T11	1120.4.26	400-50	11	21,3	1440	83,5	55	-20/+50	253
MARLIN 1120P27U-4T15	1120.4.27	400-50	15	29,8	1440	83,5	55	-20/+50	273
MARLIN 1120P28U-4T15	1120.4.28	400-50	15	29,8	1440	82,5	55	-20/+50	273
MARLIN 1120P29U-4T18,5	1120.4.29	400-50	18,5	34,5	1440	81,5	55	-20/+50	313
MARLIN 1120P30U-4T18,5	1120.4.30	400-50	18,5	34,5	1440	81,5	55	-20/+50	313
MARLIN 1120P31U-4T22	1120.4.31	400-50	22	42,5	1440	81,5	55	-20/+50	328
MARLIN 1120P32U-4T30	1120.4.32	400-50	30	55	1440	80,5	55	-20/+50	358
MARLIN 1120P33U-4T37	1120.4.33	400-50	37	67	1440	80,5	55	-20/+50	458
MARLIN 1120P34U-4T22	1120.4.34	400-50	22	42,5	1440	82,5	55	-20/+50	339
MARLIN 1120P35U-4T30	1120.4.35	400-50	30	55	1440	81,5	55	-20/+50	354
MARLIN 1120P36U-4T15	1120.4.36	400-50	15	29,8	1440	84,5	55	-20/+50	278
MARLIN 1120P37U-4T22	1120.4.37	400-50	22	42,5	1440	81,5	55	-20/+50	333
MARLIN 1120P38U-4T45	1120.4.38	400-50	45	80	1440	81,5	55	-20/+50	563
MARLIN 1120P39U-4T22	1120.4.39	400-50	22	42,5	1440	77,1	55	-20/+50	320
MARLIN 1120P40U-4T30	1120.4.40	400-50	30	55	1440	78,1	55	-20/+50	350
MARLIN 1250P1U-4T11	1250.4.1	400-50	11	21,3	1440	83,5	55	-20/+50	269
MARLIN 1250P2U-4T15	1250.4.2	400-50	15	29,8	1440	82,5	55	-20/+50	289
MARLIN 1250P3U-4T18,5	1250.4.3	400-50	18,5	34,5	1440	82,5	55	-20/+50	329
MARLIN 1250P4U-4T18,5	1250.4.4	400-50	18,5	34,5	1440	82,5	55	-20/+50	329
MARLIN 1250P5U-4T22	1250.4.5	400-50	22	42,5	1440	82,5	55	-20/+50	344
MARLIN 1250P6U-4T11	1250.4.6	400-50	11	21,3	1440	87,5	55	-20/+50	269
MARLIN 1250P7U-4T18,5	1250.4.7	400-50	18,5	34,5	1440	88,5	55	-20/+50	329
MARLIN 1250P8U-4T22	1250.4.8	400-50	22	42,5	1440	88,5	55	-20/+50	344
MARLIN 1250P9U-4T22	1250.4.9	400-50	22	42,5	1440	88,5	55	-20/+50	344
MARLIN 1250P10U-4T22	1250.4.10	400-50	22	42,5	1440	88,5	55	-20/+50	344
MARLIN 1250P11U-4T30	1250.4.11	400-50	30	55	1440	86,5	55	-20/+50	384
MARLIN 1250P12U-4T30	1250.4.12	400-50	30	55	1440	87,5	55	-20/+50	384
MARLIN 1250P13U-4T30	1250.4.13	400-50	30	55	1440	81,5	55	-20/+50	384
MARLIN 1250P14U-4T30	1250.4.14	400-50	30	55	1440	87,5	55	-20/+50	384
MARLIN 1250P15U-4T30	1250.4.15	400-50	30	55	1440	82,5	55	-20/+50	384
MARLIN 1250P16U-4T30	1250.4.16	400-50	30	55	1440	83,5	55	-20/+50	384
MARLIN 1250P17U-4T37	1250.4.17	400-50	37	67	1440	83,5	55	-20/+50	484

MODEL	MODEL NUMBER	Voltage Frequency	Motor Power	Current	Rotation Speed	Sound Pressure	Protection Class	Working Range	Mass
		V-Hz	kW	A	RPM	Lp(A) dB at 3m	IP	°C	~ Kg
MARLIN 1250P18U-4T37	1250.4.18	400-50	37	67	1440	83,5	55	-20/+50	484
MARLIN 1250P19U-4T37	1250.4.19	400-50	37	67	1440	83,5	55	-20/+50	484
MARLIN 1250P20U-4T45	1250.4.20	400-50	45	80	1440	83,5	55	-20/+50	584
MARLIN 1250P21U-4T45	1250.4.21	400-50	45	80	1440	83,5	55	-20/+50	584
MARLIN 1250P22U-4T45	1250.4.22	400-50	45	80	1440	83,5	55	-20/+50	584
MARLIN 1250P23U-4T45	1250.4.23	400-50	45	80	1440	41,5	55	-20/+50	584
MARLIN 1250P24U-4T45	1250.4.24	400-50	45	80	1440	84,5	55	-20/+50	584
MARLIN 1250P25U-4T55	1250.4.25	400-50	55	96,8	1440	85,5	55	-20/+50	614
MARLIN 1250P26U-4T55	1250.4.26	400-50	55	96,8	1440	85,5	55	-20/+50	614
MARLIN 1250P27U-4T55	1250.4.27	400-50	55	96,8	1440	85,5	55	-20/+50	614
MARLIN 1250P28U-4T22	1250.4.28	400-50	22	42,5	1440	88,5	55	-20/+50	344
MARLIN 1250P29.AU-4T22	1250.4.29.A	400-50	22	42,5	1440	88,5	55	-20/+50	344
MARLIN 1250P29.BU-4T30	1250.4.29.B	400-50	30	55	1440	88,5	55	-20/+50	384
MARLIN 1250P30U-4T30	1250.4.30	400-50	30	55	1440	86,5	55	-20/+50	384
MARLIN 1250P31U-4T30	1250.4.31	400-50	30	55	1440	86,5	55	-20/+50	384
MARLIN 1250P32U-4T45	1250.4.32	400-50	45	80	1440	84,5	55	-20/+50	584
MARLIN 1250P33U-4T55	1250.4.33	400-50	55	96,8	1440	83,5	55	-20/+50	614
MARLIN 1250P34U-4T55	1250.4.34	400-50	55	96,8	1440	83,5	55	-20/+50	614
MARLIN 1250P35U-4T55	1250.4.35	400-50	55	96,8	1440	83,5	55	-20/+50	614
MARLIN 1250P36U-4T11	1250.4.36	400-50	11	21,3	1440	76,5	55	-20/+50	274
MARLIN 1250P37U-4T18,5	1250.4.37	400-50	18,5	34,5	1440	78,8	55	-20/+50	334
MARLIN 1250P38U-4T22	1250.4.38	400-50	22	42,5	1440	79,4	55	-20/+50	349
MARLIN 1250P39U-4T30	1250.4.39	400-50	30	55	1440	84,5	55	-20/+50	389
MARLIN 1250P40U-4T30	1250.4.40	400-50	30	55	1440	85,5	55	-20/+50	389
MARLIN 1250P41U-4T37	1250.4.41	400-50	37	67	1440	82,5	55	-20/+50	489
MARLIN 1250P42U-4T37	1250.4.42	400-50	37	67	1440	83,5	55	-20/+50	489
MARLIN 1400P1U-4T22	1400.4.1	400-50	22	42,5	1440	96,5	55	-20/+50	399
MARLIN 1400P2U-4T30	1400.4.2	400-50	30	55	1440	90,5	55	-20/+50	446
MARLIN 1400P3U-4T37	1400.4.3	400-50	37	67	1440	83,5	55	-20/+50	535
MARLIN 1400P4U-4T45	1400.4.4	400-50	45	80	1440	84,5	55	-20/+50	635
MARLIN 1400P5U-4T45	1400.4.5	400-50	45	80	1440	84,5	55	-20/+50	635
MARLIN 1400P6U-4T55	1400.4.6	400-50	55	96,8	1440	88,5	55	-20/+50	665
MARLIN 1400P7U-4T55	1400.4.7	400-50	55	96,8	1440	84,5	55	-20/+50	665
MARLIN 1400P8U-4T55	1400.4.8	400-50	55	96,8	1440	85,5	55	-20/+50	675
MARLIN 1400P9U-4T75	1400.4.9	400-50	75	132	1440	87,5	55	-20/+50	760



BIFURCATED AXIAL FAN



- Motor mounted outside the air stream
- Range is available for standard and high temperature applications.
- Sizes 315 to 1000 diameter
- By isolating the motor from the system airstream, the bifurcated fan can handle a wide variety of saturated and dustladen atmospheres, heated air and hot gases.

MARLIN B - SYSTEM CURVE - 2 POLES

Ø315 / 3-4 Blade

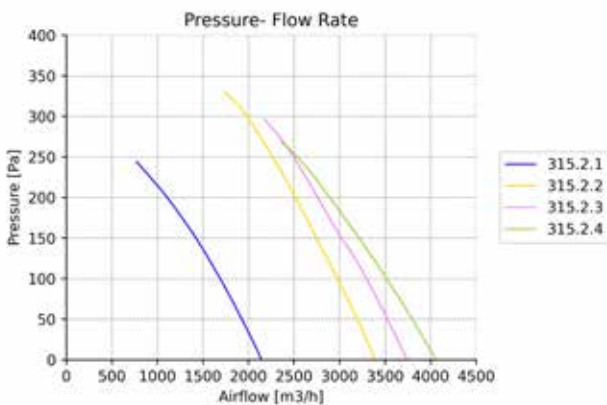

Ø355 / 3 Blade

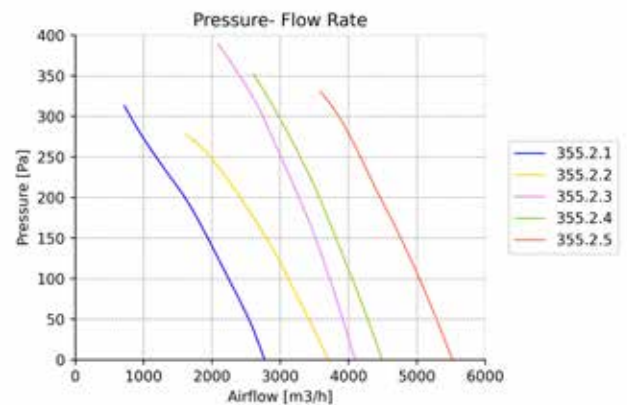

Ø400 / 3-4-5 Blade

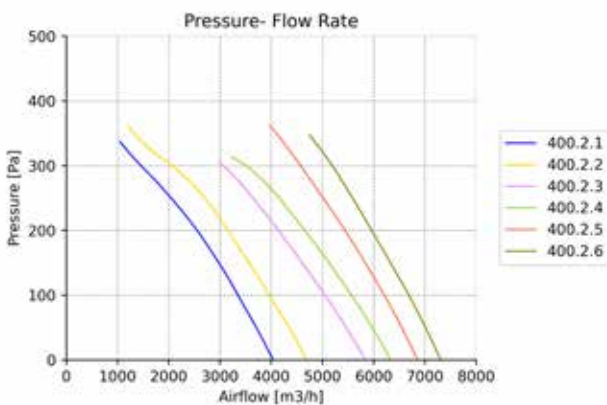

Ø400 / 6-8-10 Blade

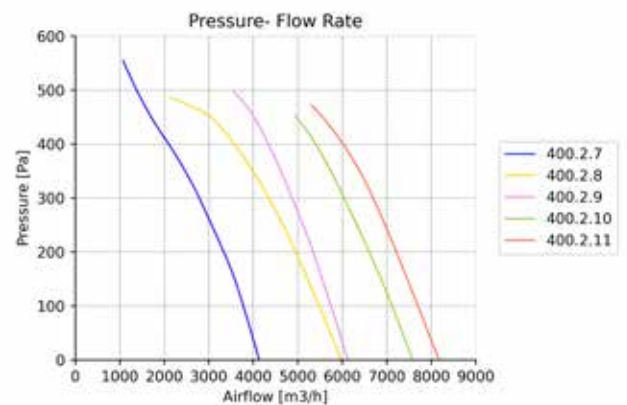

MARLIN B - SYSTEM CURVE - 2 POLES

Ø450 / 3-4-6 Blade

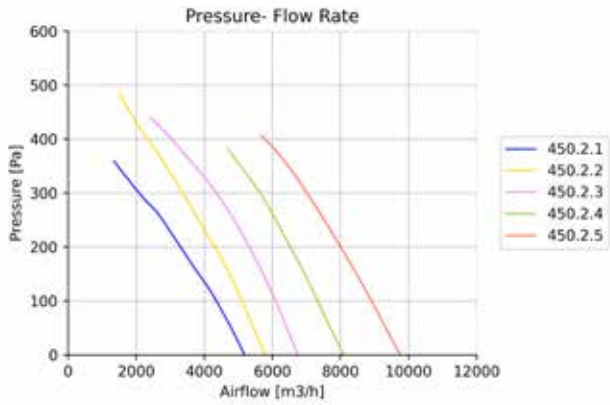

Ø450 / 5-6-8 Blade

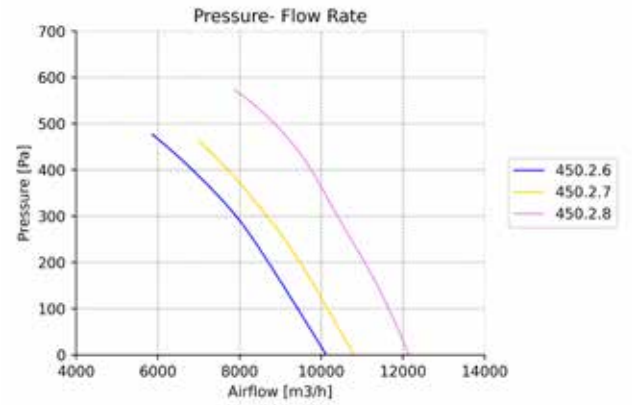

Ø500 / 3-4 Blade

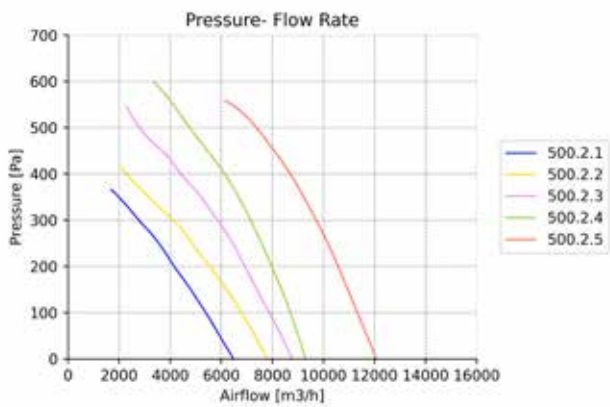

Ø500 / 5 Blade

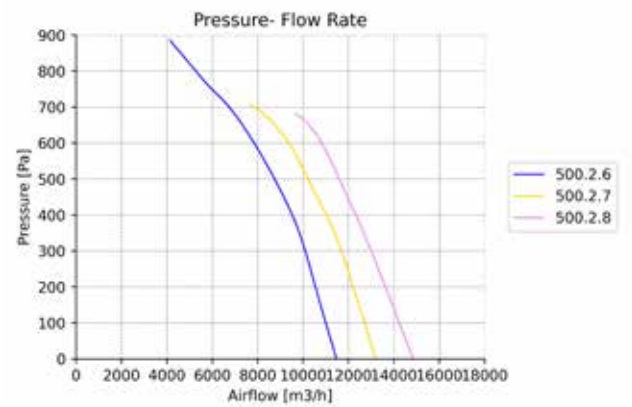

Ø560 / 3-4-5 Blade

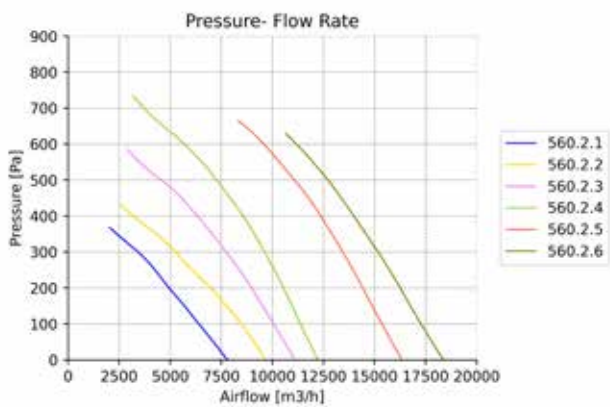

Ø560 / 6 Blade

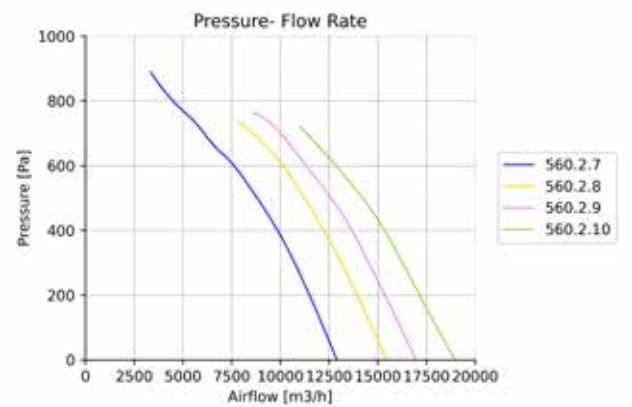

MARLIN B - SYSTEM CURVE - 2 POLES

Ø560 / 10 Blade

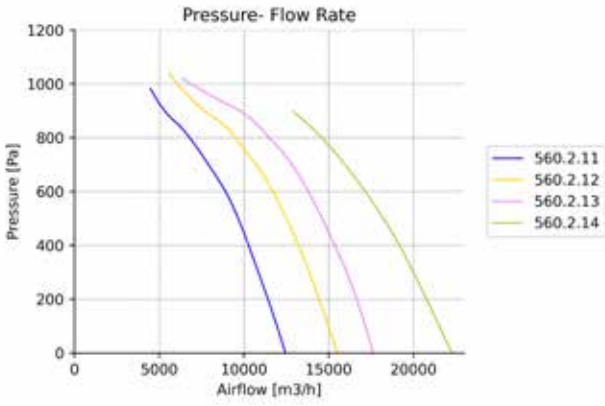

Ø630 / 3-4-5-6 Blade

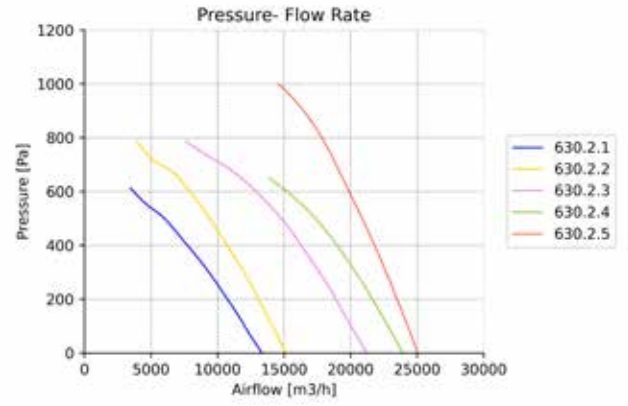

Ø630 / 6-10-12 Blade

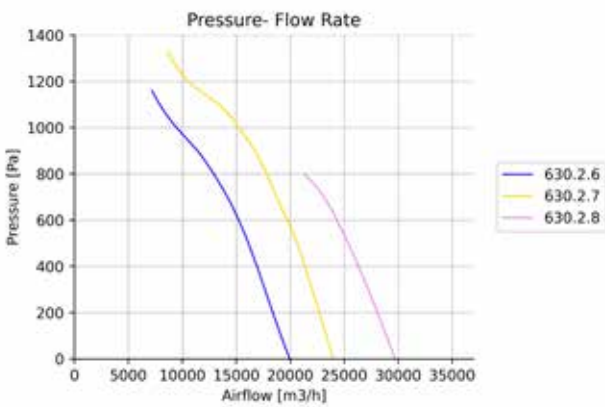

Ø710 / 3-6 Blade

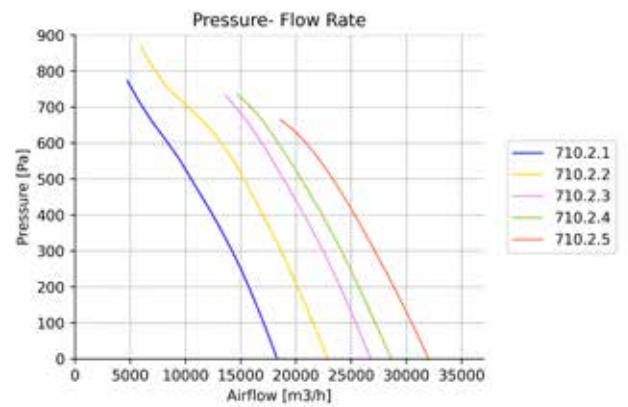

Ø710 / 6-12 Blade

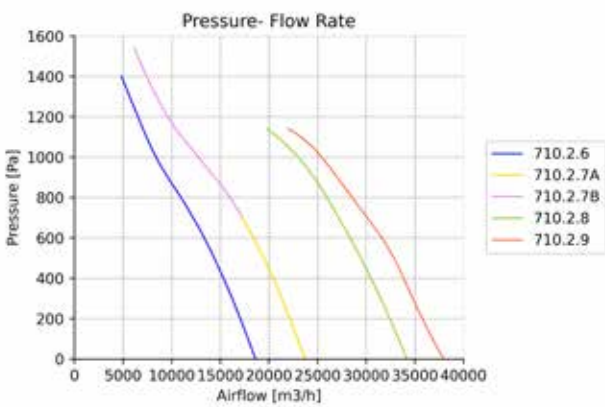

Ø800 / 3-6 Blade

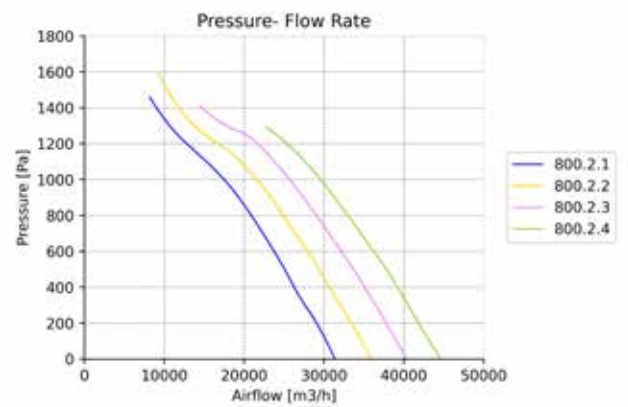

MARLIN B - SYSTEM CURVE - 2 POLES

Ø800 / 6-6 Blade

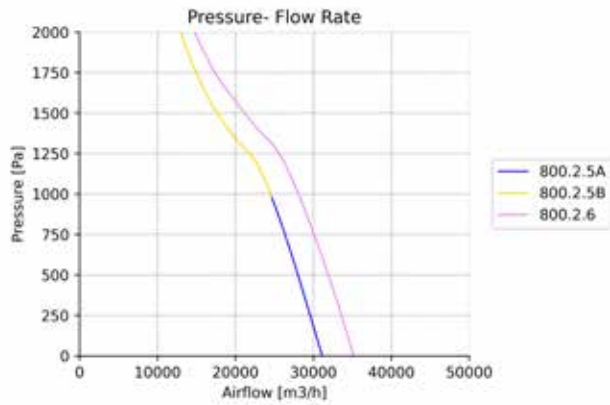

MARLIN B - SYSTEM CURVE - 4 POLES

Ø315 / 3-6 Blade

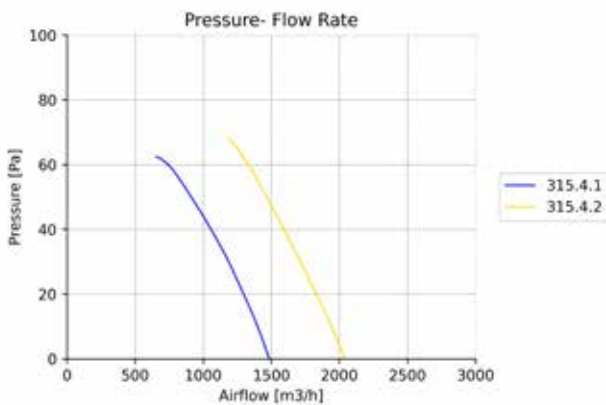

Ø355 / 4-6 Blade

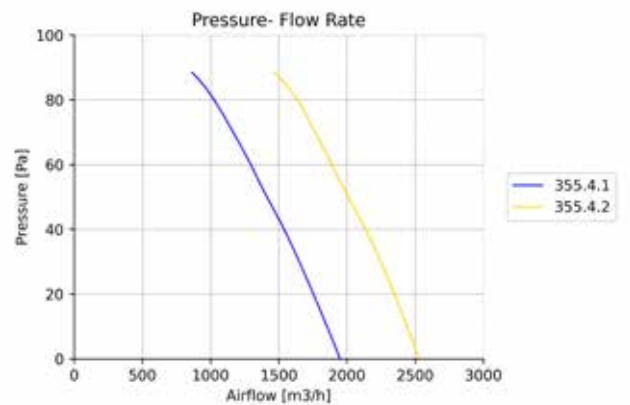

Ø400 / 6-8 Blade

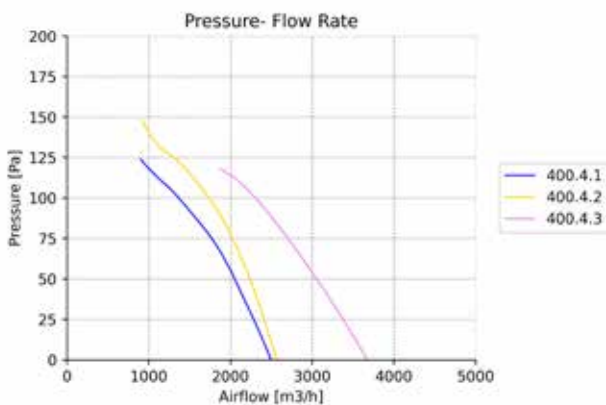

Ø450 / 6-8-10 Blade

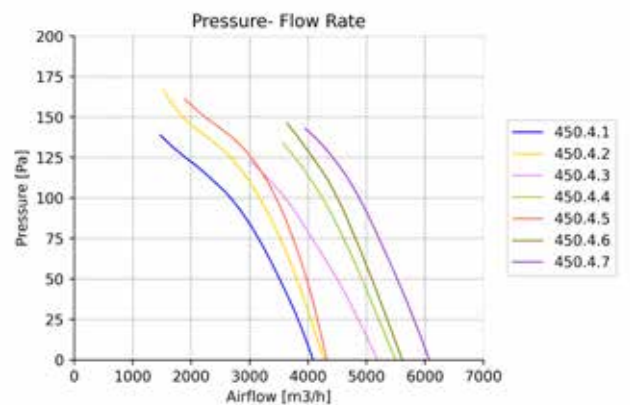

MARLIN B - SYSTEM CURVE - 4 POLES

Ø500 / 6-8-10-12 Blade

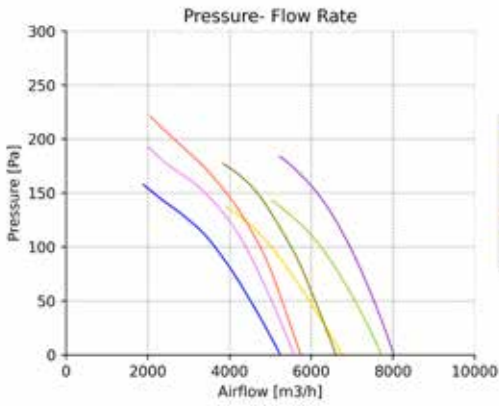

Ø560 / 3-4-6-8 Blade

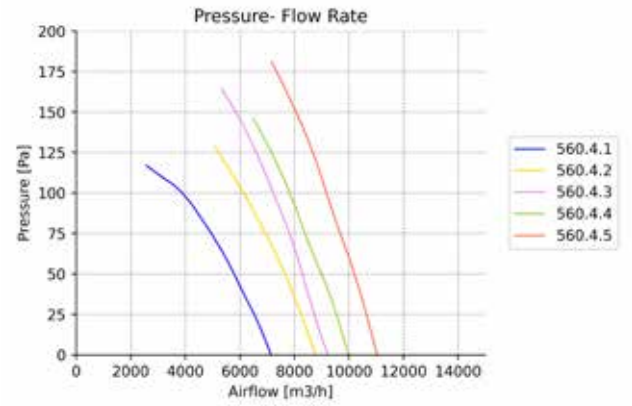

Ø560 / 10-12 Blade

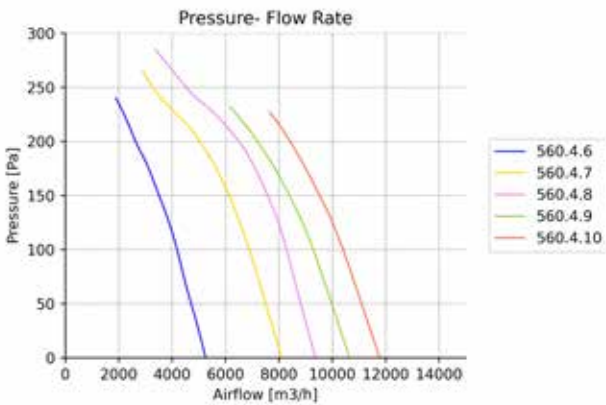

Ø630 / 5-6-8 Blade

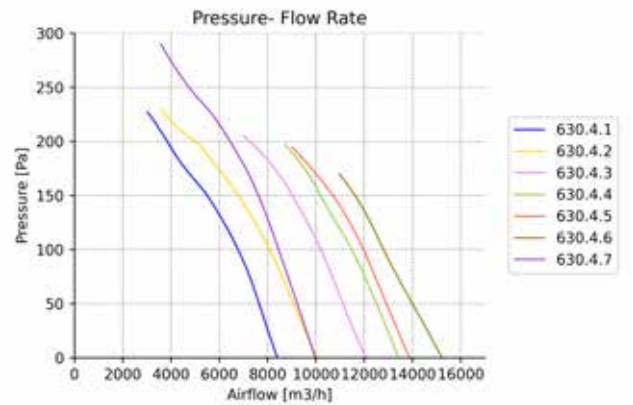

Ø630 / 10-12 Blade

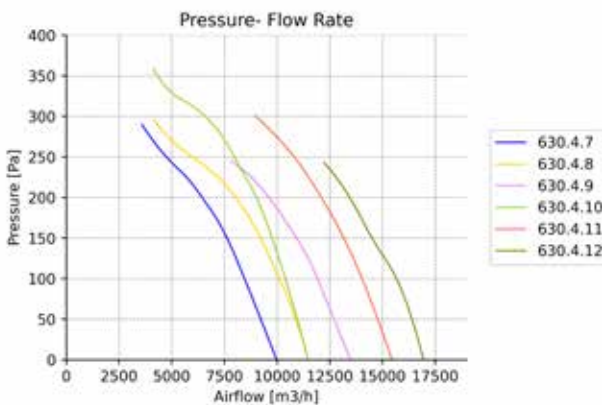

Ø710 / 5-6 Blade

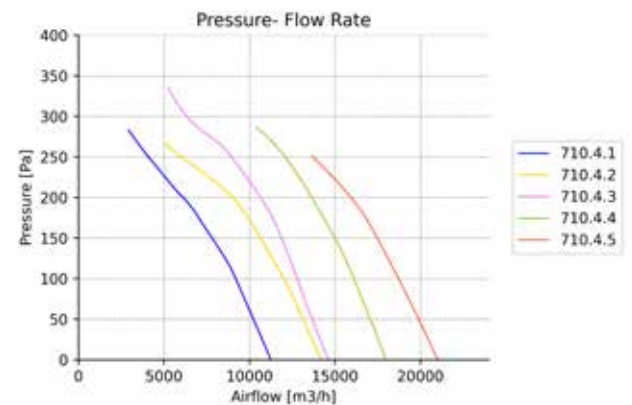

MARLIN B - SYSTEM CURVE - 4 POLES

Ø710 / 9-12 Blade

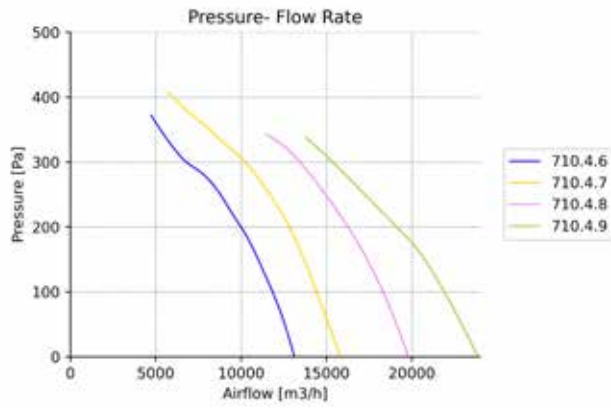

Ø800 / 6 Blade

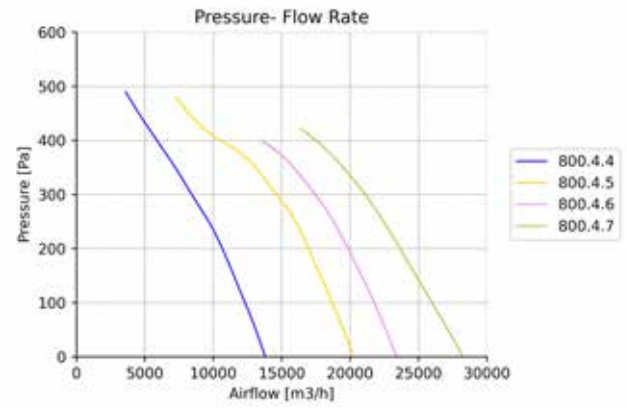

Ø800 / 8 Blade

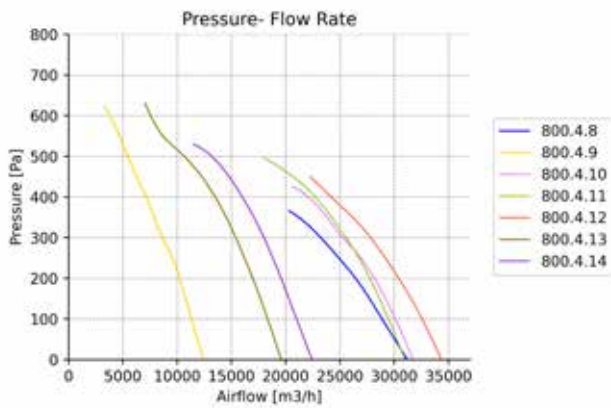

Ø900 / 6 Blade

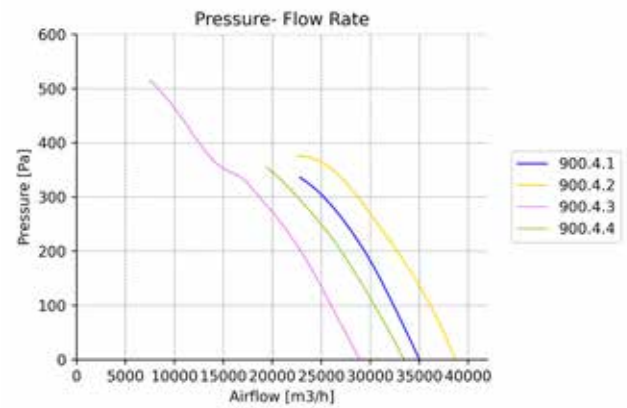

Ø900 / 8 Blade

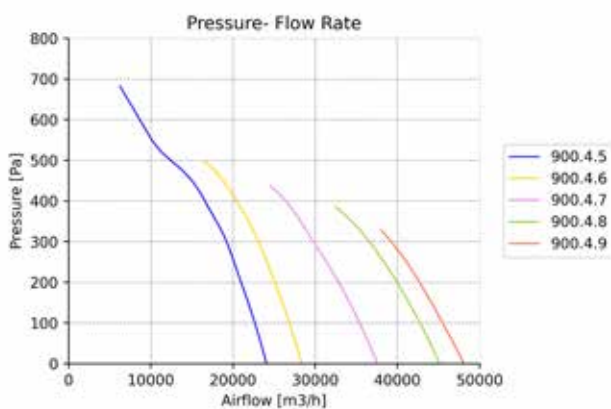

Ø900 / 9 Blade

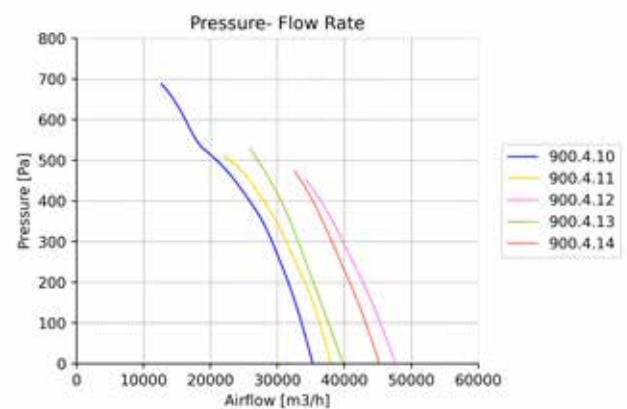

MARLIN B - SYSTEM CURVE - 4 POLES

Ø1000 / 3 Blade

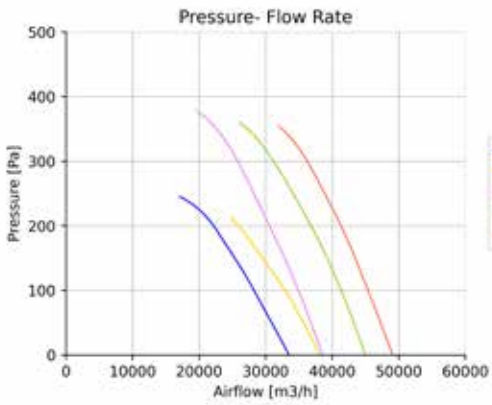

Ø1000 / 5-6 Blade

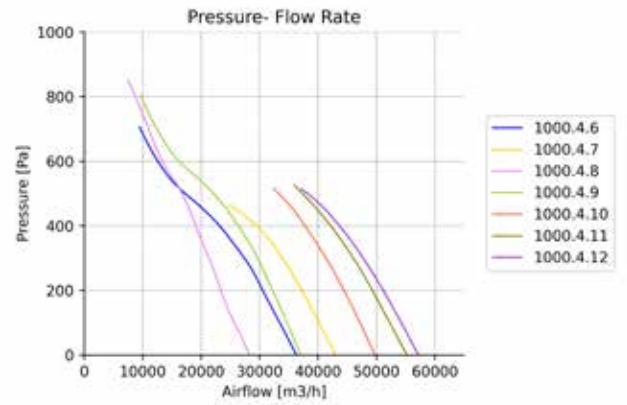

Ø1000 / 6 Blade

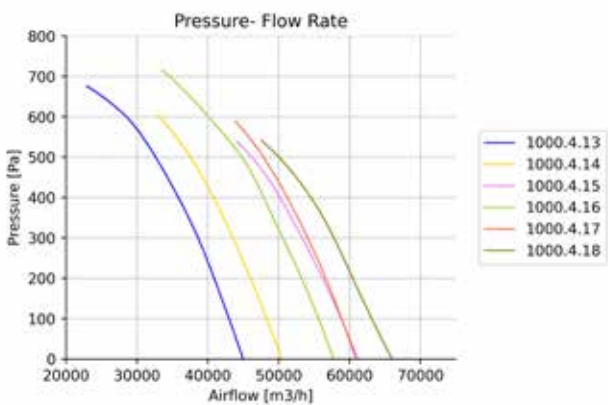

Ø1000 / 6 Blade

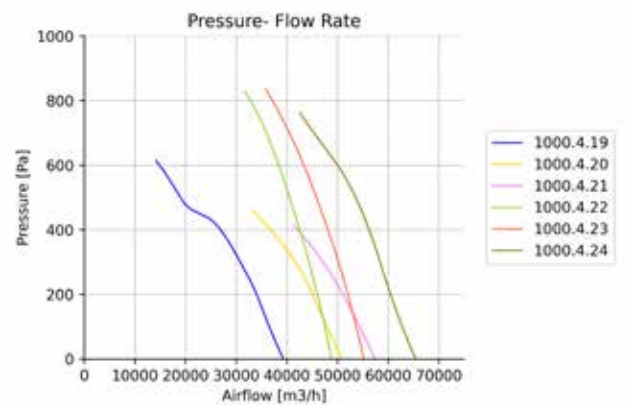

PRODUCT DIMENSIONS

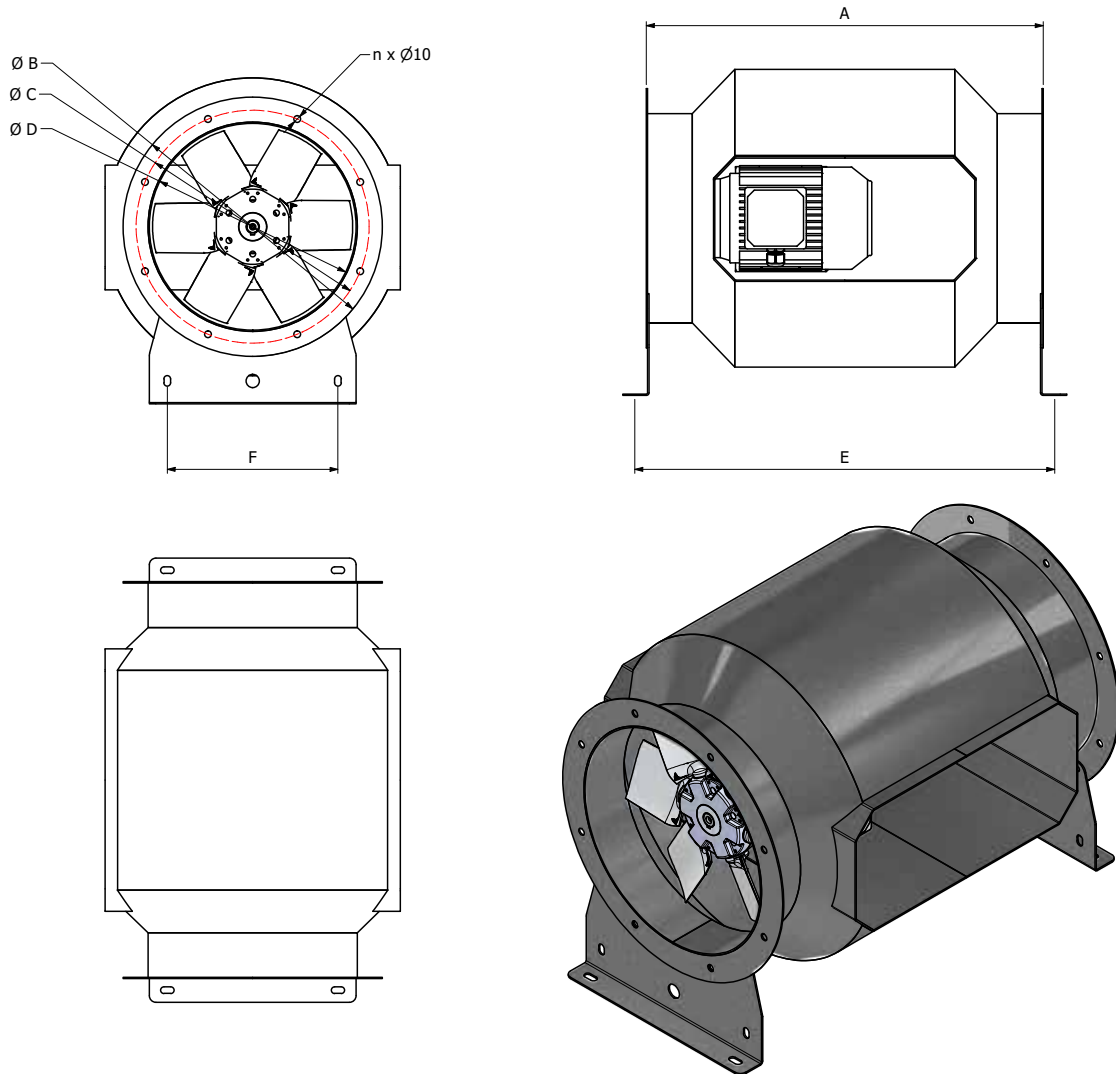

MODEL	$\varnothing Di$	$\varnothing Dd$	$\varnothing Dt$	$\varnothing Do$	$zx\varnothing D$	L	K	hf	E
315	315	500	395	355	8X10	610	643,5	270	260
355	355	540	450	405	8X12	680	720	334	300
400	400	600	500	450	8X12	790	830	370	345
450	450	630	540	495	12X12	800	840	420	395
500	500	700	590	560	12X12	856	896	445	440
560	560	660	610	585	16X12	865	905	530	500
630	630	740	685	660	16X12	865	905	600	570
710	710	820	765	740	16X15	900	940	680	650
800	800	830	815	810	16X15	1000	1040	770	740
900	900	1030	965	930	16X15	1250	1290	870	840
1000	1000	1150	1075	1040	16X15	1300	1340	970	940

TECHNICAL PARAMETERS

MODEL	MODEL NUMBER	Voltage Frequency	Motor Power	Current	Rotation Speed	Sound Pressure	Protection Class	Working Range	Mass
		V-Hz	kW	A	RPM	Lp(A) dB at 3m	IP	°C	~ Kg
MARLIN B 315A1U-2T0,37	315.2.1	400-50	0,37	1,5	2880	56,1	55	-20/+50	28
MARLIN B 315A2U-2T0,55	315.2.2	400-50	0,55	1,6	2880	58,6	55	-20/+50	29
MARLIN B 315A3U-2T0,75	315.2.3	400-50	0,75	1,7	2880	59,9	55	-20/+50	32
MARLIN B 315A4U-2T1,1	315.2.4	400-50	1,1	2,3	2880	61,1	55	-20/+50	34
MARLIN B 355A1U-2T0,37	355.2.1	400-50	0,37	1,5	2880	57,1	55	-20/+50	31
MARLIN B 355A2U-2T0,55	355.2.2	400-50	0,55	1,6	2880	57,9	55	-20/+50	32
MARLIN B 355A3U-2T0,75	355.2.3	400-50	0,75	1,7	2880	59,1	55	-20/+50	36
MARLIN B 355A4U-2T1,1	355.2.4	400-50	1,1	2,3	2880	59,4	55	-20/+50	37
MARLIN B 355A5U-2T1,5	355.2.5	400-50	1,5	3,3	2880	62,8	55	-20/+50	41
MARLIN B 400A1U-2T0,37	400.2.1	400-50	0,37	1,5	2880	61,5	55	-20/+50	33
MARLIN B 400A2U-2T0,55	400.2.2	400-50	0,55	1,6	2880	59,5	55	-20/+50	35
MARLIN B 400A3U-2T0,75	400.2.3	400-50	0,75	1,7	2880	61,6	55	-20/+50	38
MARLIN B 400A4U-2T1,1	400.2.4	400-50	1,1	2,3	2880	64,2	55	-20/+50	43
MARLIN B 400A5U-2T1,5	400.2.5	400-50	1,5	3,3	2880	64	55	-20/+50	48
MARLIN B 400A6U-2T2,2	400.2.6	400-50	2,2	4,5	2880	66,4	55	-20/+50	52
MARLIN B 400A7U-2T0,75	400.2.7	400-50	0,75	1,7	2880	64,6	55	-20/+50	38
MARLIN B 400A8U-2T1,1	400.2.8	400-50	1,1	2,3	2880	61,2	55	-20/+50	43
MARLIN B 400A9U-2T1,5	400.2.9	400-50	1,5	3,3	2880	62,4	55	-20/+50	48
MARLIN B 400A10U-2T2,2	400.2.10	400-50	2,2	4,5	2880	62,5	55	-20/+50	52
MARLIN B 400A11U-2T3	400.2.11	400-50	3	5,9	2880	65,3	55	-20/+50	63
MARLIN B 450A1U-2T0,55	450.2.1	400-50	0,55	1,6	2880	65	55	-20/+50	40
MARLIN B 450A2U-2T0,75	450.2.2	400-50	0,75	1,7	2880	68,9	55	-20/+50	44
MARLIN B 450A3U-2T1,1	450.2.3	400-50	1,1	2,3	2880	63,9	55	-20/+50	49
MARLIN B 450A4U-2T1,5	450.2.4	400-50	1,5	3,3	2880	63,3	55	-20/+50	54
MARLIN B 450A5U-2T2,2	450.2.5	400-50	2,2	4,5	2880	66,4	55	-20/+50	57
MARLIN B 450A6U-2T3	450.2.6	400-50	3	5,9	2880	67	55	-20/+50	69
MARLIN B 450A7U-2T4	450.2.7	400-50	4	7,9	2880	70,2	55	-20/+50	72
MARLIN B 450A8U-2T5,5	450.2.8	400-50	5,5	10,3	2880	66,7	55	-20/+50	97
MARLIN B 500A1U-2T0,75	500.2.1	400-50	0,75	1,7	2880	72,3	55	-20/+50	63
MARLIN B 500A2U-2T1,1	500.2.2	400-50	1,1	2,3	2880	66,8	55	-20/+50	72
MARLIN B 500A3U-2T1,5	500.2.3	400-50	1,5	3,3	2880	68,2	55	-20/+50	76
MARLIN B 500A4U-2T2,2	500.2.4	400-50	2,2	4,5	2880	62,8	55	-20/+50	80
MARLIN B 500A5U-2T3	500.2.5	400-50	3	5,9	2880	70	55	-20/+50	91
MARLIN B 500A6U-2T4	500.2.6	400-50	4	7,9	2880	68,2	55	-20/+50	96
MARLIN B 500A7U-2T5,5	500.2.7	400-50	5,5	10,3	2880	67,9	55	-20/+50	121
MARLIN B 500A8U-2T7,5	500.2.8	400-50	7,5	13,6	2880	68,7	55	-20/+50	132
MARLIN B 560A1U-2T0,75	560.2.1	400-50	0,75	1,7	2880	68,7	55	-20/+50	78
MARLIN B 560A2U-2T1,1	560.2.2	400-50	1,1	2,3	2880	66,4	55	-20/+50	79
MARLIN B 560A3U-2T1,5	560.2.3	400-50	1,5	3,3	2880	69,7	55	-20/+50	83
MARLIN B 560A4U-2T2,2	560.2.4	400-50	3	5,9	2880	70	55	-20/+50	87
MARLIN B 560A5U-2T4	560.2.5	400-50	4	7,9	2880	69,8	55	-20/+50	104
MARLIN B 560A6U-2T5,5	560.2.6	400-50	5,5	10,3	2880	71,6	55	-20/+50	128
MARLIN B 560A7U-2T3	560.2.7	400-50	3	5,9	2880	68,7	55	-20/+50	99
MARLIN B 560A8U-2T4	560.2.8	400-50	4	7,9	2880	69,2	55	-20/+50	104
MARLIN B 560A9U-2T5,5	560.2.9	400-50	5,5	10,3	2880	69,5	55	-20/+50	128
MARLIN B 560A10U-2T7,5	560.2.10	400-50	7,5	13,6	2880	71,3	55	-20/+50	140

MODEL	MODEL NUMBER	Voltage Frequency	Motor Power	Current	Rotation Speed	Sound Pressure	Protection Class	Working Range	Mass
		V-Hz	kW	A	RPM	Lp(A) dB at 3m	IP	°C	~ Kg
MARLIN B 560A11U-2T4	560.2.11	400-50	4	7,9	2880	70,3	55	-20/+50	104
MARLIN B 560A12U-2T5,5	560.2.12	400-50	5,5	10,3	2880	71,7	55	-20/+50	128
MARLIN B 560A13U-2T7,5	560.2.13	400-50	7,5	13,6	2880	70,4	55	-20/+50	140
MARLIN B 560A14U-2T11	560.2.14	400-50	11	19,5	2880	70,8	55	-20/+50	185
MARLIN B 630A1U-2T2,2	630.2.1	400-50	2,2	4,5	2880	69,7	55	-20/+50	94
MARLIN B 630A2U-2T3	630.2.2	400-50	3	5,9	2880	70,8	55	-20/+50	106
MARLIN B 630A3U-2T5,5	630.2.3	400-50	5,5	10,3	2880	71,3	55	-20/+50	136
MARLIN B 630A4U-2T7,5	630.2.4	400-50	7,5	13,6	2880	72,4	55	-20/+50	147
MARLIN B 630A5U-2T11	630.2.5	400-50	11	19,5	2880	74,7	55	-20/+50	193
MARLIN B 630A6U-2T7,5	630.2.6	400-50	7,5	13,6	2880	74,4	55	-20/+50	147
MARLIN B 630A7U-2T11	630.2.7	400-50	11	19,5	2880	72,7	55	-20/+50	193
MARLIN B 630A8U-2T15	630.2.8	400-50	15	28,3	2880	72,5	55	-20/+50	216
MARLIN B 710A1U-2T3	710.2.1	400-50	3	5,9	2880	75,8	55	-20/+50	116
MARLIN B 710A2U-2T5,5	710.2.2	400-50	5,5	10,3	2880	73	55	-20/+50	148
MARLIN B 710A3U-2T7,5	710.2.3	400-50	7,5	13,6	2880	73,3	55	-20/+50	159
MARLIN B 710A4U-2T7,5	710.2.4	400-50	7,5	13,6	2880	74,1	55	-20/+50	159
MARLIN B 710A5U-2T11	710.2.5	400-50	11	19,5	2880	75,9	55	-20/+50	218
MARLIN B 710A6U-2T5,5	710.2.6	400-50	5,5	10,3	2880	83,5	55	-20/+50	148
MARLIN B 710A7AU-2T7,5	710.2.7A	400-50	7,5	13,6	2880	79,5	55	-20/+50	159
MARLIN B 710A7BU-2T11	710.2.7B	400-50	11	19,5	2880	79,5	55	-20/+50	218
MARLIN B 710A8U-2T15	710.2.8	400-50	15	28,3	2880	77,5	55	-20/+50	240
MARLIN B 710A9U-2T18,5	710.2.9	400-50	18,5	32,3	2880	78,5	55	-20/+50	275
MARLIN B 800A1U-2T11	800.2.1	400-50	11	19,5	2880	78,5	55	-20/+50	232
MARLIN B 800A2U-2T15	800.2.2	400-50	15	28,3	2880	79,5	55	-20/+50	255
MARLIN B 800A3U-2T18,5	800.2.3	400-50	18,5	32,3	2880	81,5	55	-20/+50	290
MARLIN B 800A4U-2T22	800.2.4	400-50	22	38,3	2880	82,5	55	-20/+50	341
MARLIN B 800A5AU-2T15	800.2.5A	400-50	15	28,3	2880	82,5	55	-20/+50	255
MARLIN B 800A5BU-2T18,5	800.2.5B	400-50	18,5	32,3	2880	82,5	55	-20/+50	290
MARLIN B 800A6U-2T22	800.2.6	400-50	22	38,3	2880	82,5	55	-20/+50	341
MARLIN B 315A1U-4T0,37	315.4.1	400-50	0,37	1,13	1440	46,1	55	-20/+50	30
MARLIN B 315A2U-4T0,37	315.4.2	400-50	0,37	1,13	1440	46,2	55	-20/+50	31
MARLIN B 355A1U-4T0,37	355.4.1	400-50	0,37	1,13	1440	43,5	55	-20/+50	34
MARLIN B 355A2U-4T0,37	355.4.2	400-50	0,37	1,13	1440	45,1	55	-20/+50	34
MARLIN B 400A1U-4T0,37	400.4.1	400-50	0,37	1,13	1440	47,5	55	-20/+50	37
MARLIN B 400A2U-4T0,37	400.4.2	400-50	0,37	1,13	1440	47,7	55	-20/+50	37
MARLIN B 400A3U-4T0,37	400.4.3	400-50	0,37	1,13	1440	48,6	55	-20/+50	37
MARLIN B 450A1U-4T0,37	450.4.1	400-50	0,37	1,13	1440	49,7	55	-20/+50	42
MARLIN B 450A2U-4T0,37	450.4.2	400-50	0,37	1,13	1440	51,6	55	-20/+50	43
MARLIN B 450A3U-4T0,37	450.4.3	400-50	0,37	1,13	1440	51,7	55	-20/+50	42
MARLIN B 450A4U-4T0,55	450.4.4	400-50	0,55	1,55	1440	50,4	55	-20/+50	43
MARLIN B 450A5U-4T0,37	450.4.5	400-50	0,37	1,13	1440	50,4	55	-20/+50	44
MARLIN B 450A6U-4T0,55	450.4.6	400-50	0,55	1,55	1440	50,4	55	-20/+50	44
MARLIN B 450A7U-4T0,75	450.4.7	400-50	0,75	2	1440	50,5	55	-20/+50	50
MARLIN B 500A1U-4T0,37	500.4.1	400-50	0,37	1,13	1440	48,7	55	-20/+50	62
MARLIN B 500A2U-4T0,55	500.4.2	400-50	0,55	1,55	1440	53,5	55	-20/+50	62
MARLIN B 500A3U-4T0,37	500.4.3	400-50	0,37	1,13	1440	54,6	55	-20/+50	63

MODEL	MODEL NUMBER	Voltage Frequency	Motor Power	Current	Rotation Speed	Sound Pressure	Protection Class	Working Range	Mass
		V-Hz	kW	A	RPM	Lp(A) dB at 3m	IP	°C	~ Kg
MARLIN B 500A4U-4T0,75	500.4.4	400-50	0,75	2	1440	53,8	55	-20/+50	69
MARLIN B 500A5U-4T0,55	500.4.5	400-50	0,55	1,55	1440	54,8	55	-20/+50	64
MARLIN B 500A6U-4T0,75	500.4.6	400-50	0,75	2	1440	54,8	55	-20/+50	70
MARLIN B 500A7U-4T1,1	500.4.7	400-50	1,1	2,6	1440	55,5	55	-20/+50	81
MARLIN B 560A1U-4T0,37	560.4.1	400-50	0,37	1,13	1440	55,6	55	-20/+50	76
MARLIN B 560A2U-4T0,55	560.4.2	400-50	0,55	1,55	1440	55,2	55	-20/+50	77
MARLIN B 560A3U-4T0,75	560.4.3	400-50	0,75	2	1440	56,5	55	-20/+50	83
MARLIN B 560A4U-4T0,75	560.4.4	400-50	0,75	2	1440	57	55	-20/+50	83
MARLIN B 560A5U-4T1,1	560.4.5	400-50	1,1	2,6	1440	56,7	55	-20/+50	87
MARLIN B 560A6U-4T0,37	560.4.6	400-50	0,37	1,13	1440	57,3	55	-20/+50	78
MARLIN B 560A7U-4T0,75	560.4.7	400-50	0,75	2	1440	56,8	55	-20/+50	84
MARLIN B 560A8U-4T1,1	560.4.8	400-50	1,1	2,6	1440	55,8	55	-20/+50	88
MARLIN B 560A9U-4T1,1	560.4.9	400-50	1,1	2,6	1440	56,3	55	-20/+50	88
MARLIN B 560A10U-4T1,5	560.4.10	400-50	1,5	3,5	1440	57,2	55	-20/+50	93
MARLIN B 630A1U-4T0,55	630.4.1	400-50	0,55	1,55	1440	57	55	-20/+50	85
MARLIN B 630A2U-4T0,75	630.4.2	400-50	0,75	2	1440	55,2	55	-20/+50	92
MARLIN B 630A3U-4T1,1	630.4.3	400-50	1,1	2,6	1440	58,6	55	-20/+50	95
MARLIN B 630A4U-4T1,5	630.4.4	400-50	1,5	3,5	1440	59,4	55	-20/+50	100
MARLIN B 630A5U-4T0,75	630.4.5	400-50	0,75	2	1440	58,2	55	-20/+50	91
MARLIN B 630A6U-4T2,2	630.4.6	400-50	2,2	5	1440	62,1	55	-20/+50	103
MARLIN B 630A7U-4T0,75	630.4.7	400-50	0,75	2	1440	64	55	-20/+50	92
MARLIN B 630A8U-4T1,1	630.4.8	400-50	1,1	2,6	1440	57,5	55	-20/+50	95
MARLIN B 630A9U-4T1,5	630.4.9	400-50	1,5	3,5	1440	58	55	-20/+50	100
MARLIN B 630A11U-4T1,5	630.4.11	400-50	1,5	3,5	1440	62,3	55	-20/+50	101
MARLIN B 630A12U-4T2,2	630.4.12	400-50	2,2	5	1440	62,4	55	-20/+50	104
MARLIN B 630A13U-4T3	630.4.13	400-50	3	6,6	1440	63,8	55	-20/+50	115
MARLIN B 710A1U-4T0,75	710.4.1	400-50	0,75	2	1440	62,8	55	-20/+50	102
MARLIN B 710A2U-4T1,5	710.4.2	400-50	1,5	3,5	1440	60	55	-20/+50	110
MARLIN B 710A3U-4T1,5	710.4.3	400-50	1,5	3,5	1440	62,9	55	-20/+50	111
MARLIN B 710A4U-4T2,2	710.4.4	400-50	2,2	5	1440	63	55	-20/+50	114
MARLIN B 710A5U-4T3	710.4.5	400-50	3	6,6	1440	65,1	55	-20/+50	125
MARLIN B 710A6U-4T1,5	710.4.6	400-50	1,5	3,5	1440	60,8	55	-20/+50	114
MARLIN B 710A7U-4T2,2	710.4.7	400-50	2,2	5	1440	64,8	55	-20/+50	115
MARLIN B 710A8U-4T3	710.4.8	400-50	3	6,6	1440	64	55	-20/+50	126
MARLIN B 710A9U-4T4	710.4.9	400-50	4	8,4	1440	63,5	55	-20/+50	139
MARLIN B 800A1U-4T2,2	800.4.1	400-50	2,2	5	1440	67,8	55	-20/+50	126
MARLIN B 800A2U-4T3	800.4.2	400-50	3	6,6	1440	65,1	55	-20/+50	135
MARLIN B 800A3U-4T4	800.4.3	400-50	4	8,4	1440	65,6	55	-20/+50	157
MARLIN B 800A4U-4T5,5	800.4.4	400-50	5,5	11,2	1440	67,8	55	-20/+50	175
MARLIN B 800A5U-4T1,5	800.4.5	400-50	1,5	3,5	1440	70,2	55	-20/+50	123
MARLIN B 800A6U-4T3	800.4.6	400-50	3	6,6	1440	69,1	55	-20/+50	137
MARLIN B 800A7U-4T4	800.4.7	400-50	4	8,4	1440	67,7	55	-20/+50	159
MARLIN B 800A8U-4T5,5	800.4.8	400-50	5,5	11,2	1440	66,7	55	-20/+50	176
MARLIN B 800A9U-4T7,5	800.4.9	400-50	7,5	15,4	1440	67,7	55	-20/+50	187
MARLIN B 800A10U-4T2,2	800.4.10	400-50	2,2	5	1440	69,3	55	-20/+50	128
MARLIN B 800A11U-4T11	800.4.11	400-50	11	21,3	1440	68,1	55	-20/+50	269

MODEL	MODEL NUMBER	Voltage Frequency	Motor Power	Current	Rotation Speed	Sound Pressure	Protection Class	Working Range	Mass
		V-Hz	kW	A	RPM	Lp(A) dB at 3m	IP	°C	~ Kg
MARLIN B 800A12U-4T7,5	800.4.12	400-50	7,5	15,4	1440	67,9	55	-20/+50	189
MARLIN B 800A13U-4T11	800.4.13	400-50	11	21,3	1440	68,4	55	-20/+50	269
MARLIN B 800A14U-4T4	800.4.14	400-50	4	8,4	1440	69	55	-20/+50	169
MARLIN B 900A1U-4T5,5	900.4.1	400-50	5,5	11,2	1440	73,7	55	-20/+50	191
MARLIN B 900A2U-4T7,5	900.4.2	400-50	7,5	15,4	1440	67,5	55	-20/+50	202
MARLIN B 900A3U-4T4	900.4.3	400-50	4	8,4	1440	67,3	55	-20/+50	175
MARLIN B 900A4U-4T5,5	900.4.4	400-50	5,5	11,2	1440	67,4	55	-20/+50	192
MARLIN B 900A5U-4T4	900.4.5	400-50	4	8,4	1440	70,9	55	-20/+50	175
MARLIN B 900A6U-4T5,5	900.4.6	400-50	5,5	11,2	1440	70,1	55	-20/+50	192
MARLIN B 900A7U-4T7,5	900.4.7	400-50	7,5	15,4	1440	70,2	55	-20/+50	203
MARLIN B 900A8U-4T11	900.4.8	400-50	11	21,3	1440	69,9	55	-20/+50	285
MARLIN B 900A9U-4T15	900.4.9	400-50	15	29,8	1440	69	55	-20/+50	317
MARLIN B 900A10U-4T7,5	900.4.10	400-50	7,5	15,4	1440	72,9	55	-20/+50	205
MARLIN B 900A11U-4T11	900.4.11	400-50	11	21,3	1440	74,8	55	-20/+50	287
MARLIN B 900A12U-4T15	900.4.12	400-50	15	29,8	1440	71,3	55	-20/+50	320
MARLIN B 900A13U-4T11	900.4.13	400-50	11	21,3	1440	70,4	55	-20/+50	295
MARLIN B 900A14U-4T15	900.4.14	400-50	15	29,8	1440	68,6	55	-20/+50	327
MARLIN B 1000A1U-4T3	1000.4.1	400-50	3	6,6	1440	68	55	-20/+50	196
MARLIN B 1000A2U-4T4	1000.4.2	400-50	4	8,4	1440	69,5	55	-20/+50	226
MARLIN B 1000A3U-4T5,5	1000.4.3	400-50	5,5	11,2	1440	69,4	55	-20/+50	253
MARLIN B 1000A4U-4T7,5	1000.4.4	400-50	7,5	15,4	1440	72,7	55	-20/+50	265
MARLIN B 1000A5U-4T11	1000.4.5	400-50	11	21,3	1440	74,4	55	-20/+50	381
MARLIN B 1000A6U-4T5,5	1000.4.6	400-50	5,5	11,2	1440	68,8	55	-20/+50	255
MARLIN B 1000A7U-4T7,5	1000.4.7	400-50	7,5	15,4	1440	70,3	55	-20/+50	266
MARLIN B 1000A8U-4T5,5	1000.4.8	400-50	5,5	11,2	1440	71,9	55	-20/+50	257
MARLIN B 1000A9U-4T7,5	1000.4.9	400-50	7,5	15,4	1440	75	55	-20/+50	268
MARLIN B 1000A10U-4T11	1000.4.10	400-50	11	21,3	1440	73,4	55	-20/+50	381
MARLIN B 1000A11U-4T15	1000.4.11	400-50	15	29,8	1440	74,8	55	-20/+50	413
MARLIN B 1000A12U-4T15	1000.4.12	400-50	15	29,8	1440	75,4	55	-20/+50	413
MARLIN B 1000A13U-4T11	1000.4.13	400-50	11	21,3	1440	77,5	55	-20/+50	381
MARLIN B 1000A14U-4T15	1000.4.14	400-50	15	29,8	1440	75,4	55	-20/+50	413
MARLIN B 1000A15U-4T22	1000.4.15	400-50	22	42,5	1440	76,5	55	-20/+50	501
MARLIN B 1000A16U-4T30	1000.4.16	400-50	30	55	1440	76,1	55	-20/+50	520
MARLIN B 1000A17U-4T22	1000.4.17	400-50	22	42,5	1440	74,5	55	-20/+50	508
MARLIN B 1000A18U-4T30	1000.4.18	400-50	30	55	1440	74,8	55	-20/+50	532
MARLIN B 1000A19U-4T7,5	1000.4.19	400-50	7,5	15,4	1440	75,8	55	-20/+50	258
MARLIN B 1000A20U-4T11	1000.4.20	400-50	11	21,3	1440	72,9	55	-20/+50	372
MARLIN B 1000A21U-4T15	1000.4.21	400-50	15	29,8	1440	72,4	55	-20/+50	404
MARLIN B 1000A22U-4T22	1000.4.22	400-50	22	42,5	1440	79,5	55	-20/+50	501
MARLIN B 1000A23U-4T30	1000.4.23	400-50	30	55	1440	78,5	55	-20/+50	525
MARLIN B 1000A24U-4T37	1000.4.24	400-50	37	67	1440	77,5	55	-20/+50	685

NOVVES

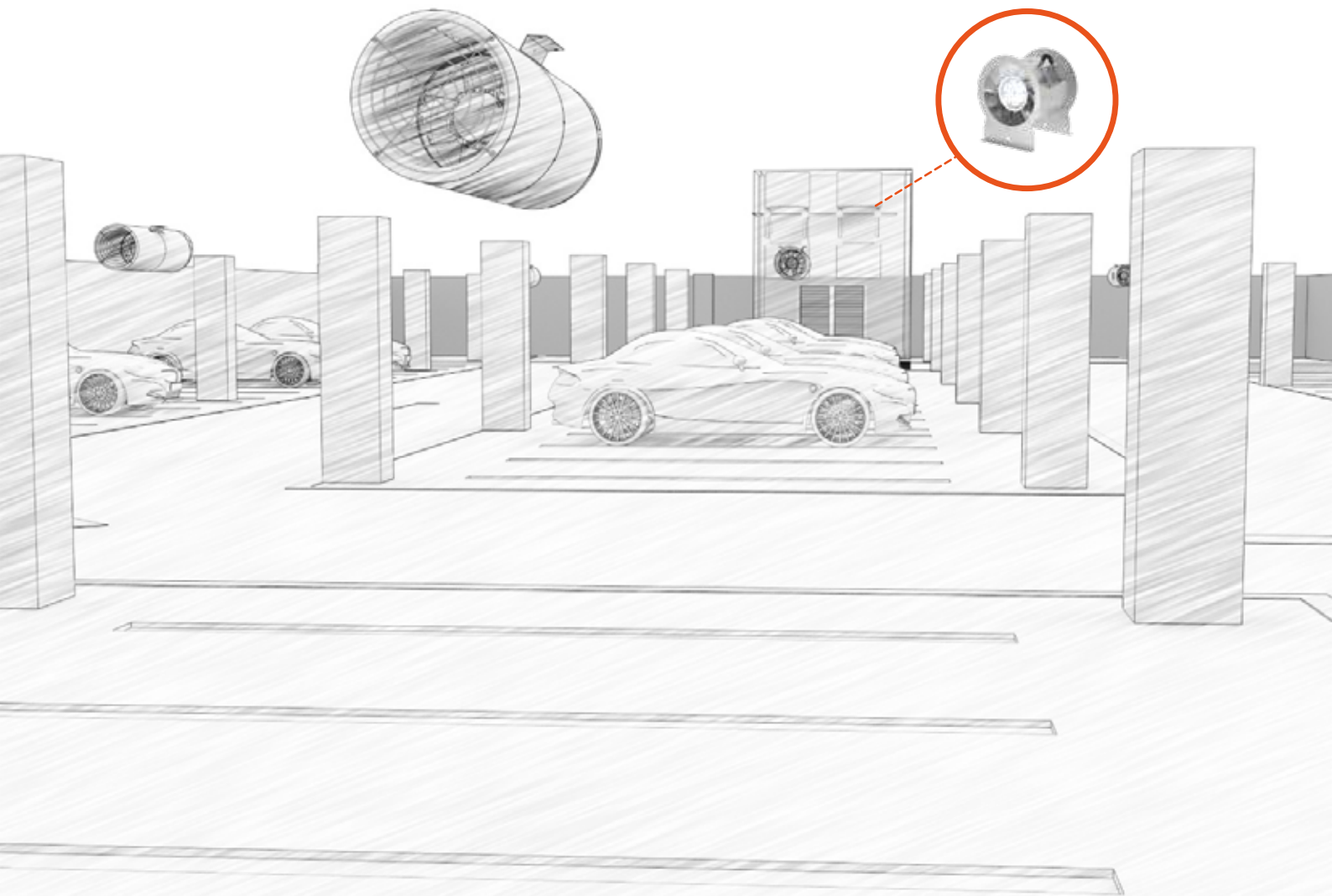

Dragonfly

Smoke and Heat Extract Fan

DRAGONFLY SERIES

DRAGONFLY



General

The Dragonfly series, produced in accordance with high temperature conditions for smoke and heat evacuation, is used for evacuation of toxic and suffocating gases formed during fire. F300 class fire resistance certified smoke fans are manufactured to withstand 300°C for 2 hours uninterrupted. It is used not only during fires, but also for evacuation of polluted air containing gases such as carbon monoxide and hydrocarbons in parking lots during normal times. Aerofil blades are high pressure resistant and made of aluminum casting. While the adjustable blade angles provide a perfect performance by meeting the flow and pressure expectations according to the needs, it also provides an advantage in operating costs with its high efficiency working capacity resulting from the blade design. It provides ease of assembly with its short and long frame options, and it offers the opportunity to be mounted directly to the air ducts, inside shaft and roof floor with its compact structure.

Body

The body, which is made of electrostatic powder coated steel, can also be produced from hot-dip galvanized optionally. The motor and fan impeller are connected to the main body with steel carriers.

Impeller

It has fire resistant aluminum alloy casting blades and fan core. Axial blades with aerodynamically optimized aerofoil provide high efficiency. Impellers are dynamically and statically balanced in accordance with ISO 1940.

Motor

All models are equipped with a three-phase asynchronous F300 smoke evacuation motor. All models can be used for continuous operation or emergency operation.

IP Class

All products of this series have IP 55 class protection and H class insulation.

Control

It can be operated directly with the help of the MCC board. Speed adjustment can be made with frequency inverter.

Fan Code

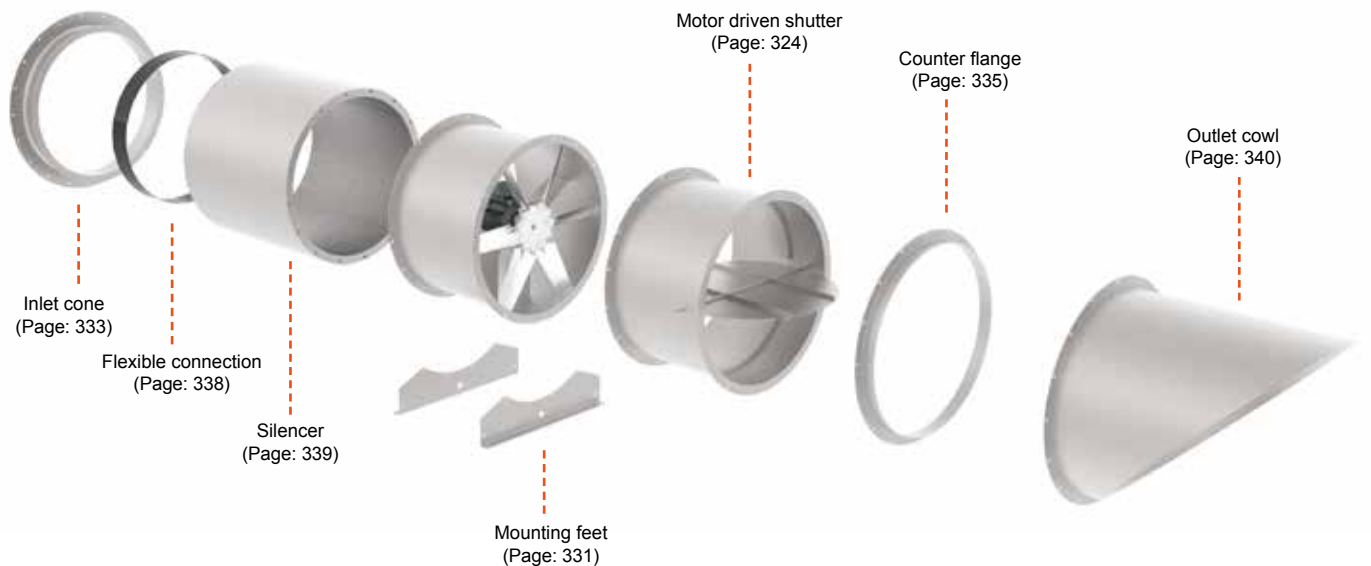
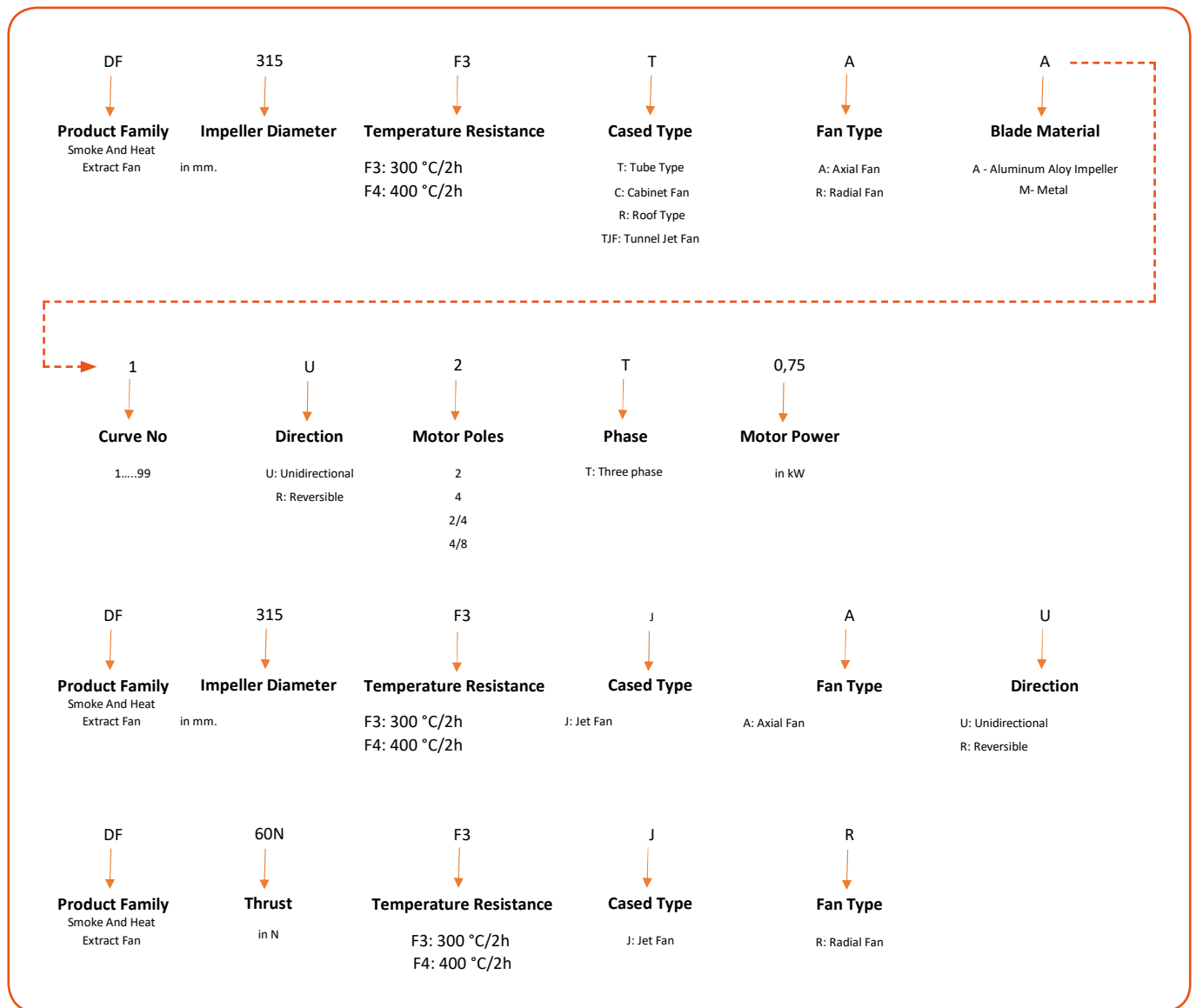

NOVVES JET FAN SYSTEM SOLUTIONS

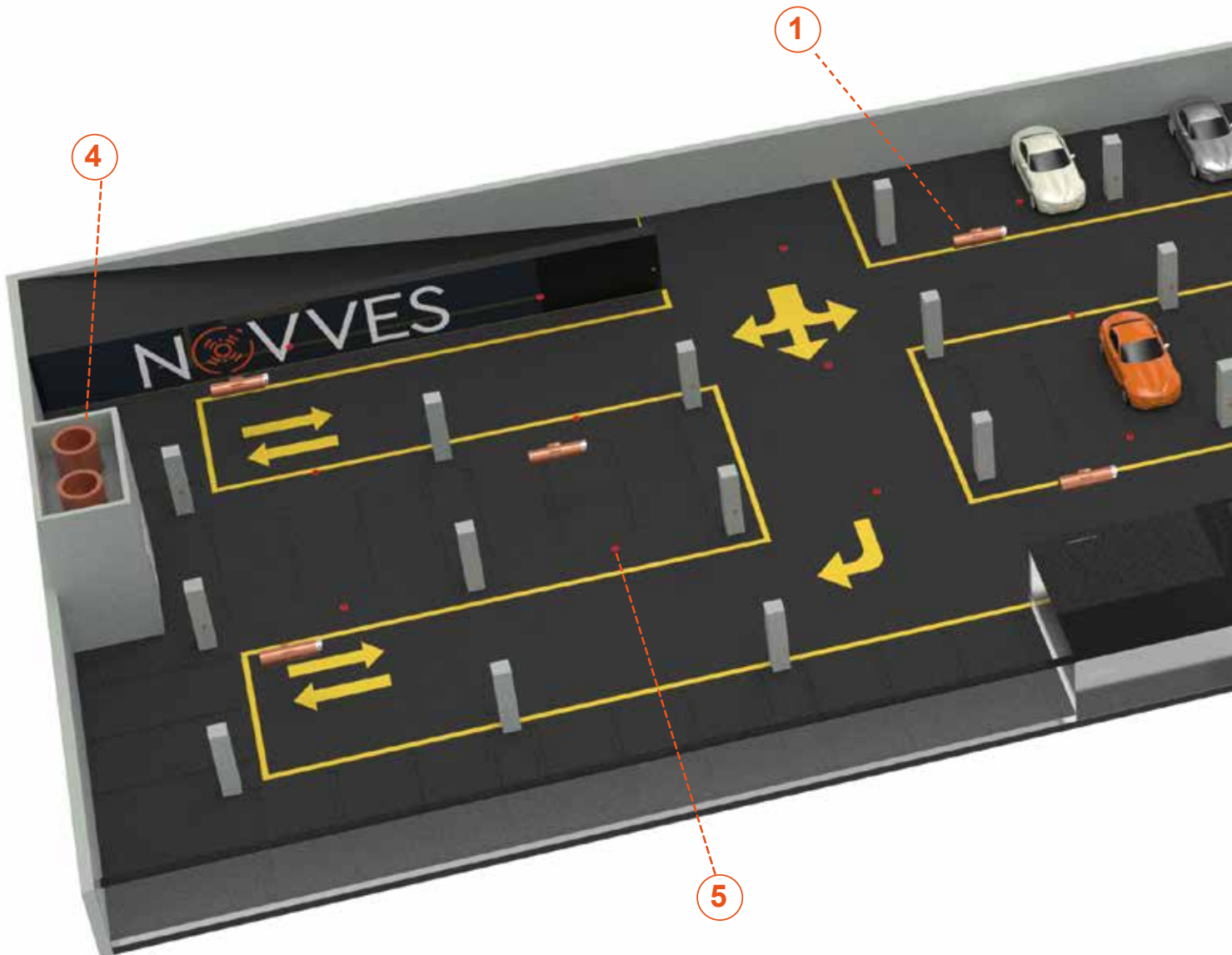

1. Jet Fan: Jet Fans, which have been used in horizontal ventilation systems, create a flow of air at sufficient speed to sweep the area to be ventilated. They direct smoke in case of fire and polluted air in case of air pollution to exhaust shaft. Jet fans are produced as axial and radial. Radial Fans have lower heights and are suitable for car parks with height less. Our Jet Fans are called Dragonfly by Novves.

2. Motorized Smoke Damper: They are used for smoke control. Required scenario step in when signal comes from CO or fire detector. Then dampers, which have multi-function servo systems, become open or close position according to scenario by actuator controls. Opening the damper allows air from outside a building to inside, in order to cool the interior, or it can close to contain the inside air.

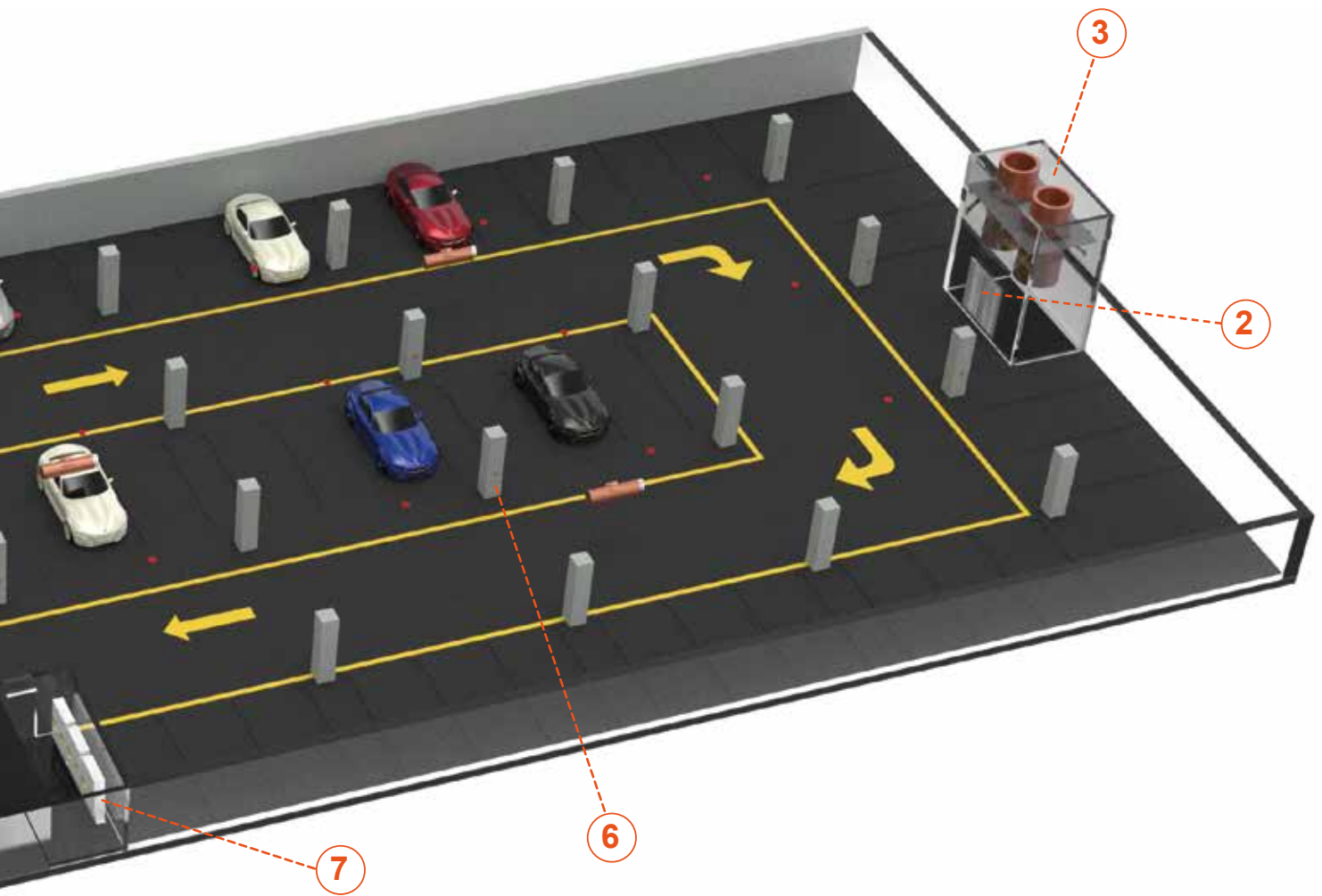

3. Fresh Air Fan: Fresh air is an essential to direct smoke and polluted air to exhaust shaft. These fans provide air reinforcement and direct air to exhaust on course and timely. **Smoke Extract Fan (F300,F400):** They have F300 and F400 Fire-resistance rating. Fan exhausts smoke according to a fire scenario.

4. Fresh Air Fan: Fresh air is an essential to direct smoke and polluted air to exhaust shaft. These fans provide air reinforcement and direct air to exhaust on course and timely.

5. Fresh Air Fan: Fresh air is an essential to direct smoke and polluted air to exhaust shaft. These fans provide air reinforcement and direct air to exhaust on course and timely. **Smoke and Heat Sensor:** It is an electronic fire- protection device that automatically senses the presence of smoke, as a key indication of fire.

6. Fresh Air Fan: Fresh air is an essential to direct smoke and polluted air to exhaust shaft. These fans provide air reinforcement and direct air to exhaust on course and timely. **CO Detector:** When a carbon monoxide which is a colorless, odorless and tasteless flammable gas level of 50 parts per million (PPM), CO detector triggers an alarm to alert.

7. MCC Panel

SMOKE AND HEAT EXTRACT TUBE FANS



- Body is electrostatic powder painted for resistance to corrosion, optionally, the body can manufacture from hot dip galvanized sheet
- Double speed motor option,
- Adjustable blade angle
- Dynamically balanced aluminum impeller with heat treated high temperature resistance in accordance with ISO 1940
- Suitable for horizontal and vertical mounting
- Resistant to 300 degrees for 2 hours according to EN 12101-3 (No 2184-CPR-0031)
- Rotational speed can be set with frequency inverter

DRAGONFLY T - SYSTEM CURVE - 2 POLES

Ø315 / 3-4 Blade

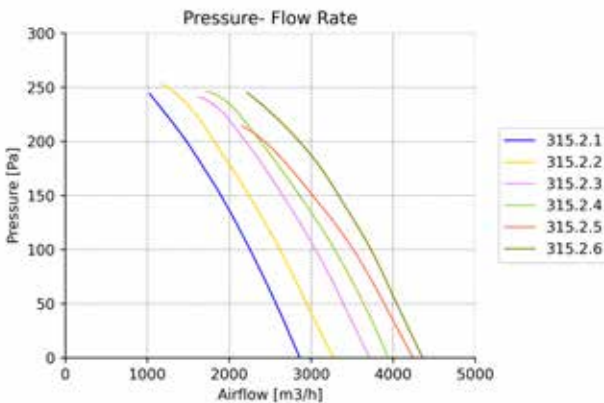

Ø315 / 6 Blade

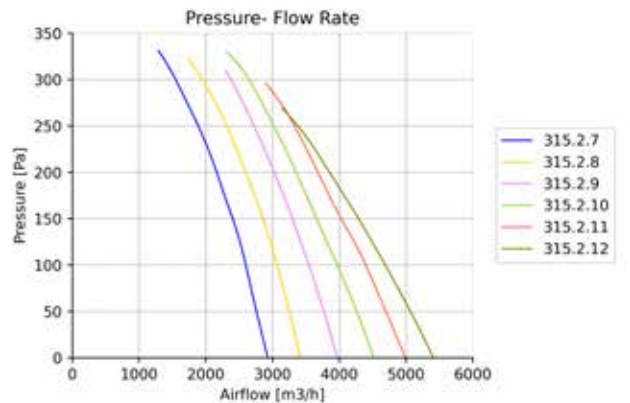

Ø355 / 3 Blade

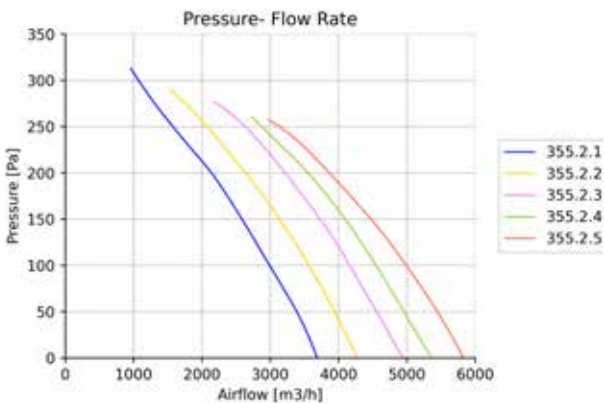

Ø355 / 4-6-8 Blade

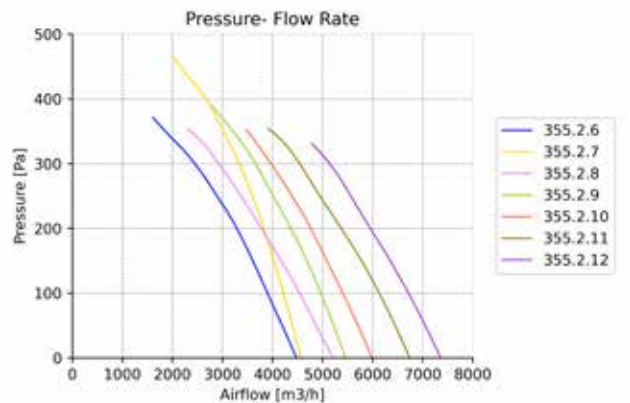

DRAGONFLY T - SYSTEM CURVE - 2 POLES

Ø400 / 3-4-5 Blade

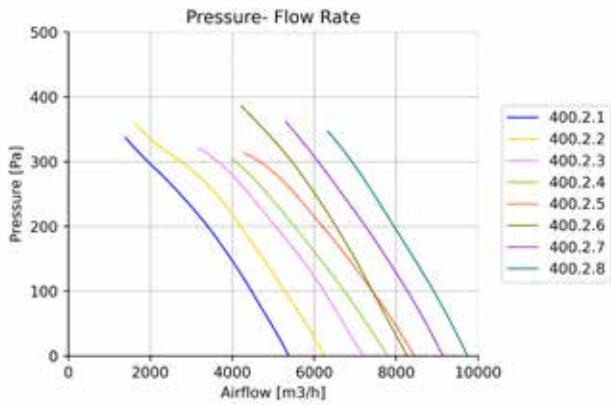

Ø400 / 6-8-10 Blade

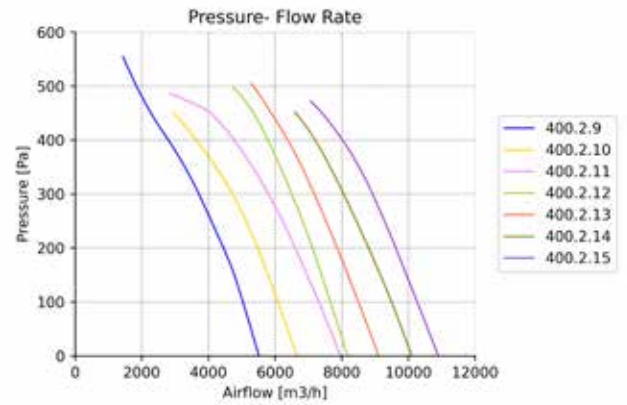

Ø450 / 3-4-6 Blade

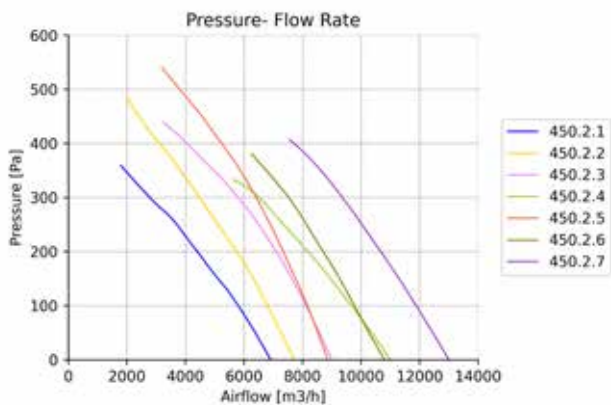

Ø450 / 5-6-8 Blade

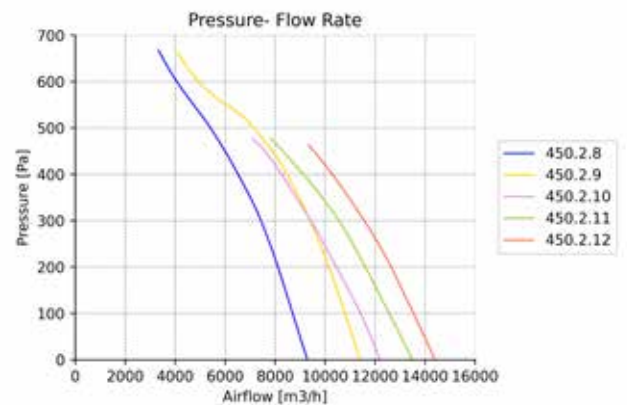

Ø450 / 10 Blade

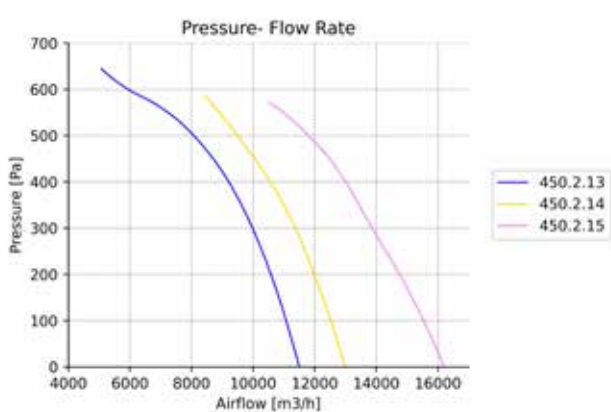

Ø500 / 3-4 Blade

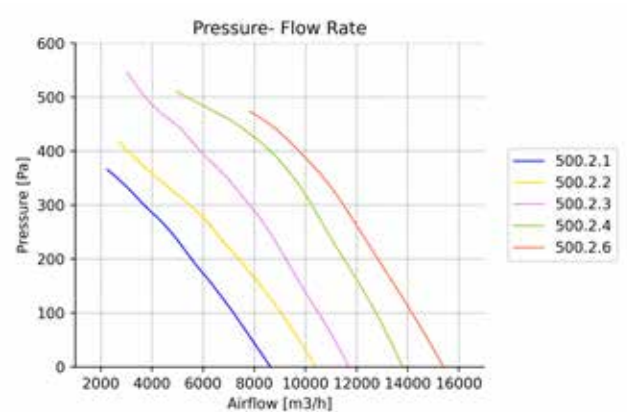

DRAGONFLY T - SYSTEM CURVE - 2 POLES

Ø500 / 5 Blade

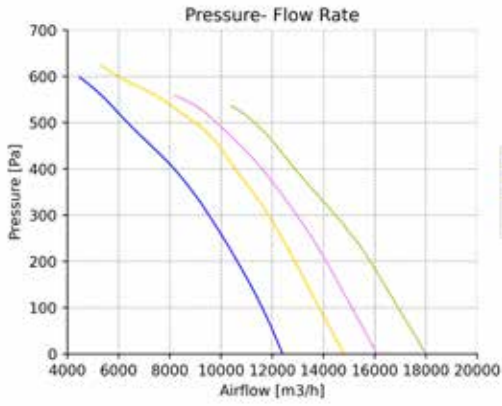

Ø500 / 10 Blade

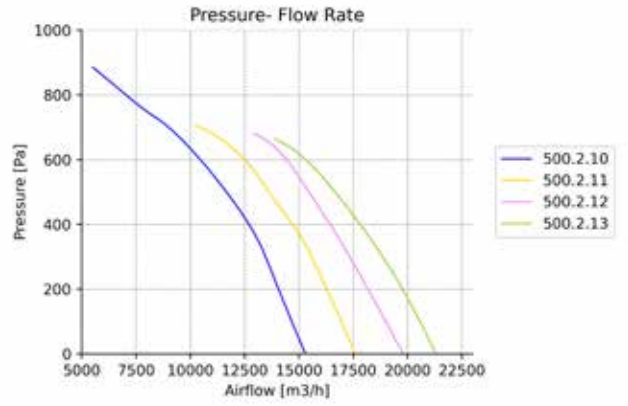

Ø560 / 3-4-5 Blade

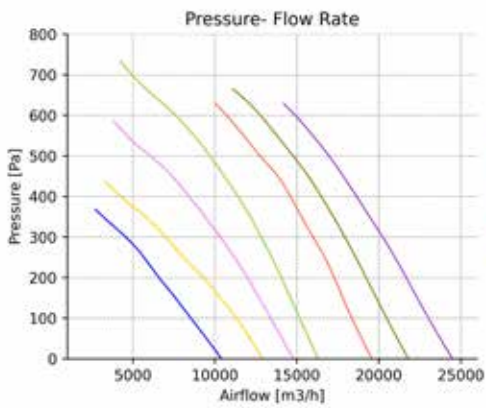

Ø560 / 6 Blade

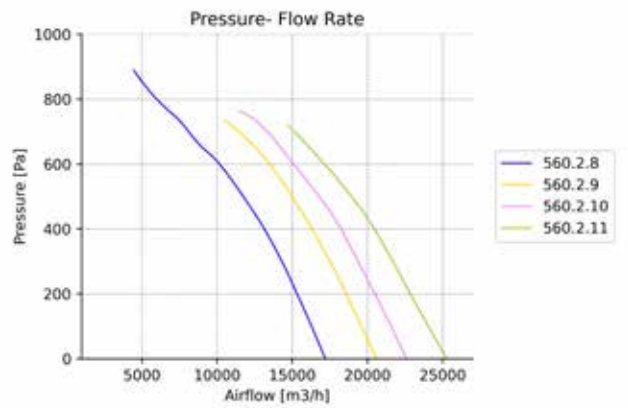

Ø560 / 10 Blade

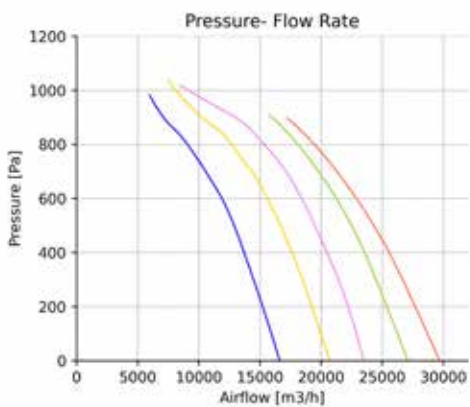

Ø630 / 3-4-5-6 Blade

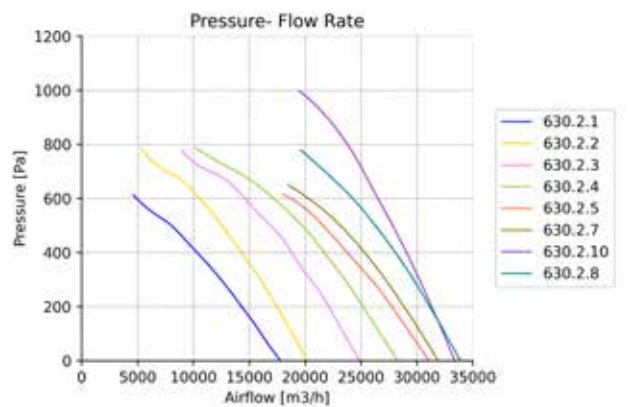

DRAGONFLY T - SYSTEM CURVE - 2 POLES

Ø630 / 6-10-12 Blade

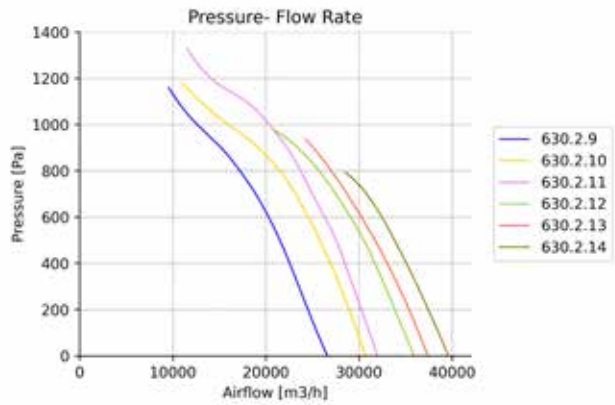

Ø710 / 3-6 Blade

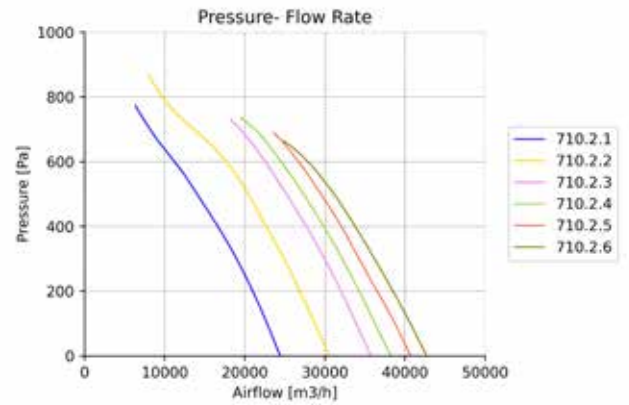

Ø710 / 6-12 Blade

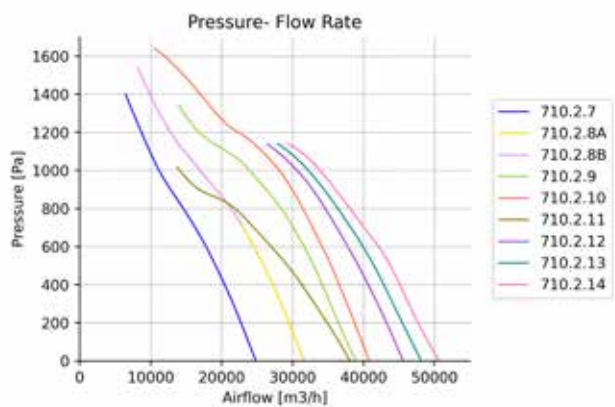

Ø800 / 3-6 Blade

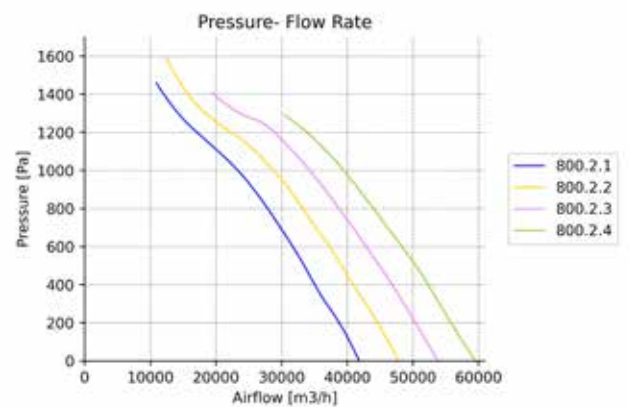

Ø800 / 6-6 Blade

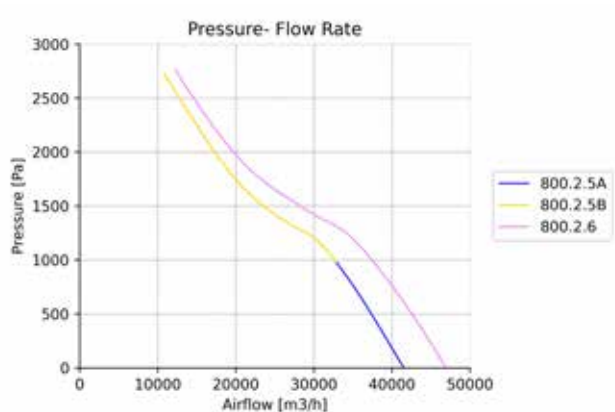

DRAGONFLY T - SYSTEM CURVE - 4 POLES

Ø315 / 3-6 Blade

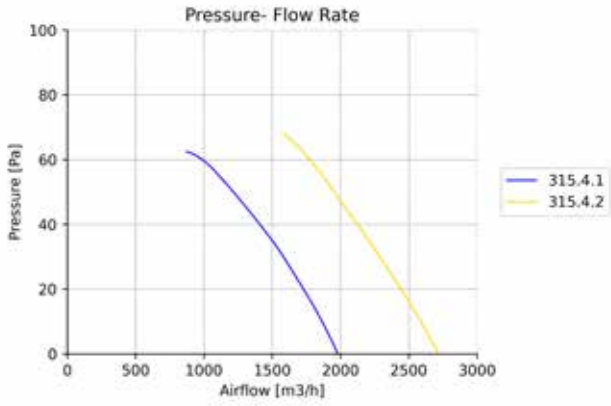

Ø355 / 4-6 Blade

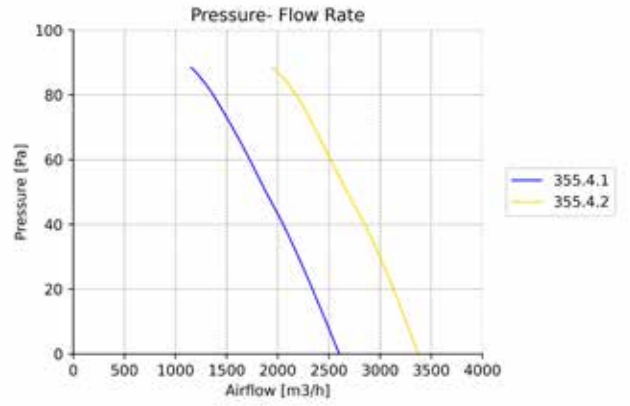

Ø400 / 6-8 Blade

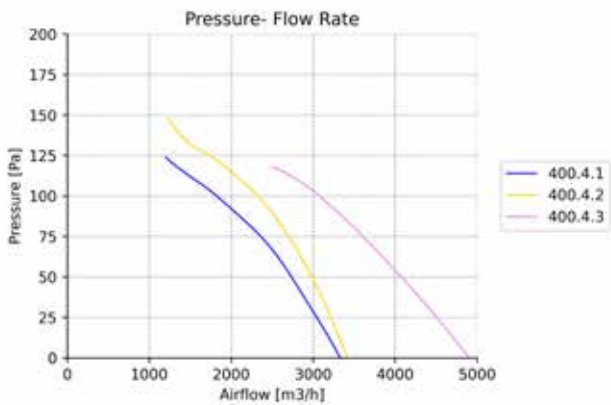

Ø450 / 6-8-10 Blade

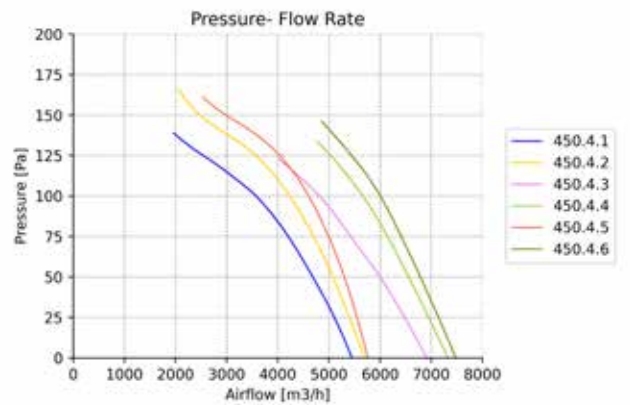

Ø500 / 6-8-10-12 Blade

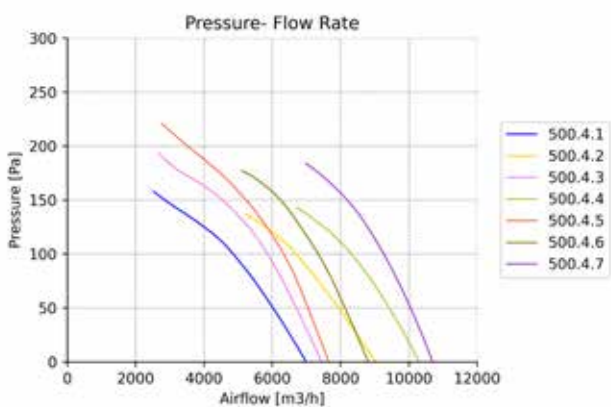

Ø560 / 3-4-6-8 Blade

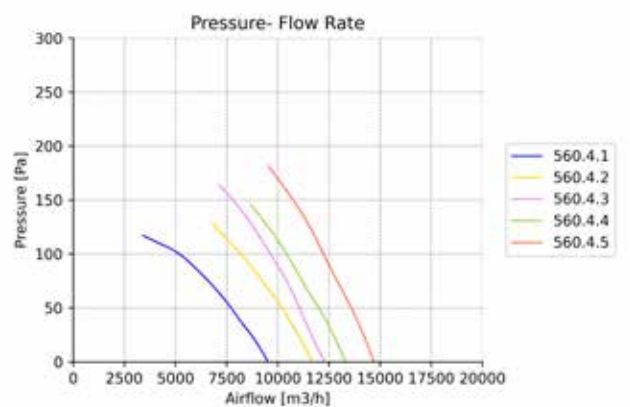

DRAGONFLY T - SYSTEM CURVE - 4 POLES

Ø560 / 10-12 Blade

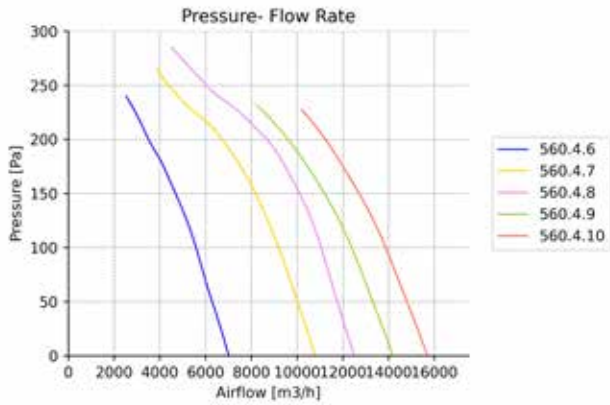

Ø630 / 5-6-8 Blade

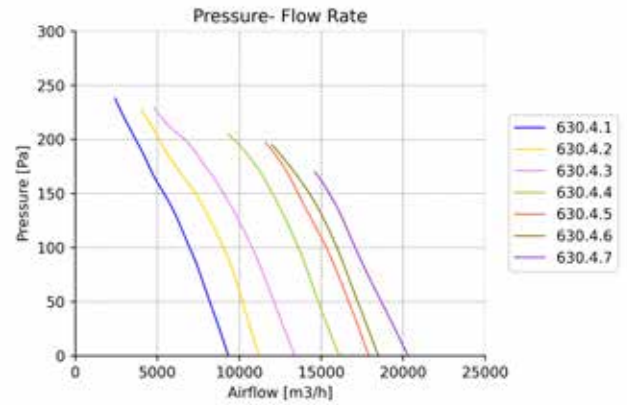

Ø630 / 10-12 Blade

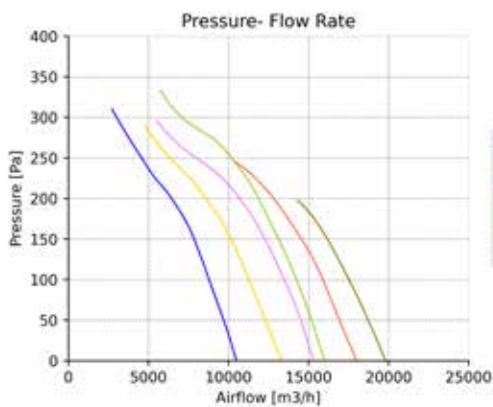

Ø630 / 9-12 Blade

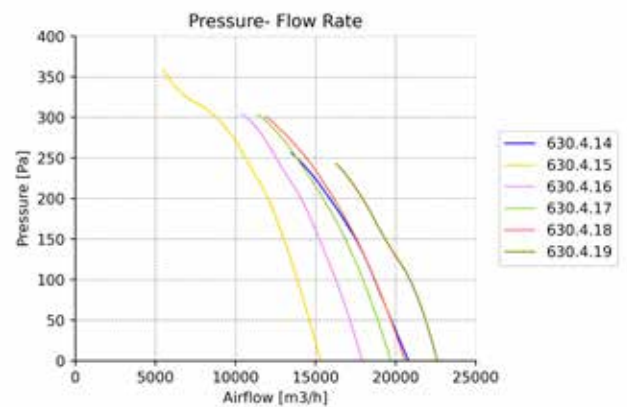

Ø710 / 5-6 Blade

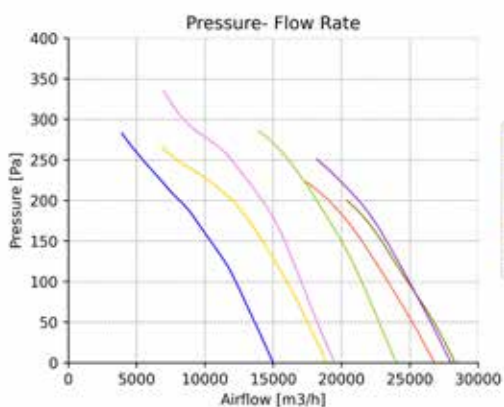

Ø710 / 9-12 Blade

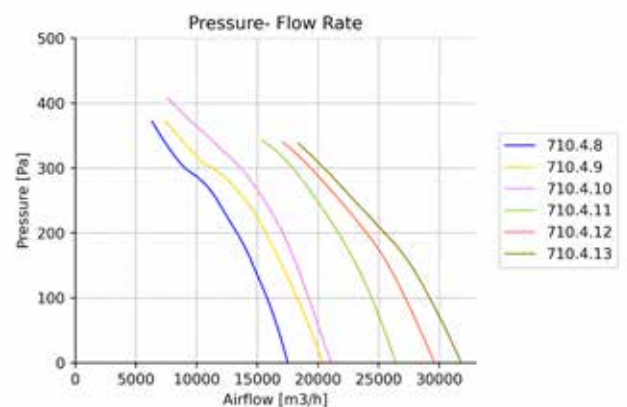

DRAGONFLY T - SYSTEM CURVE - 4 POLES

Ø800 / 6 Blade

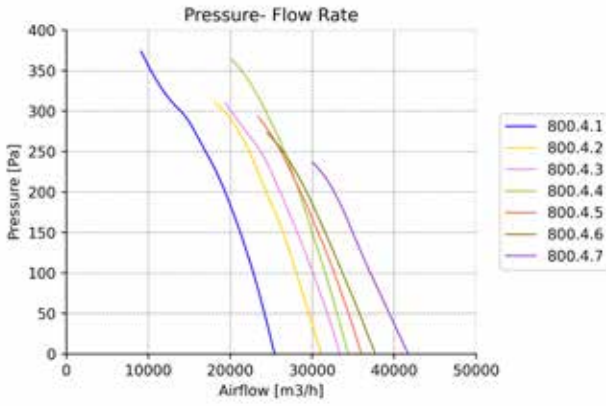

Ø800 / 8 Blade

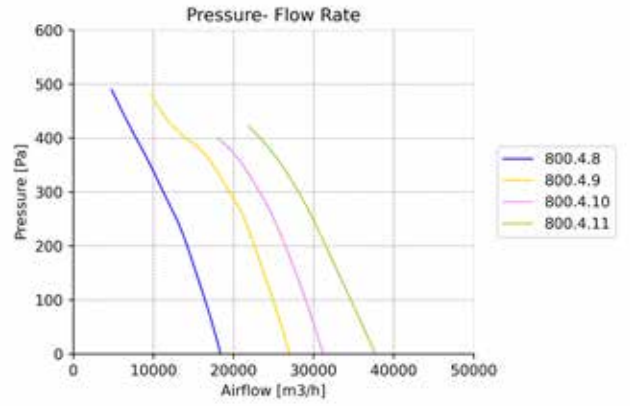

Ø800 / 9-12 Blade

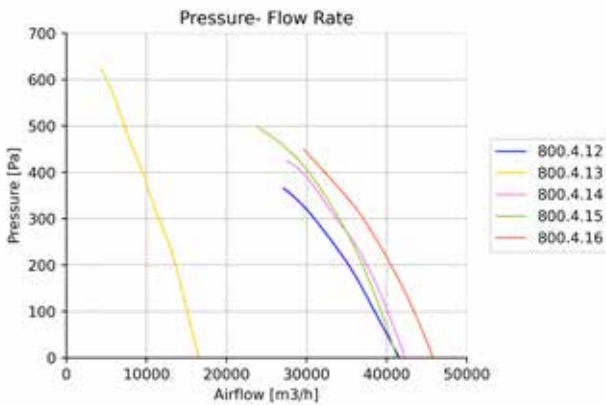

Ø800 / 6 Blade

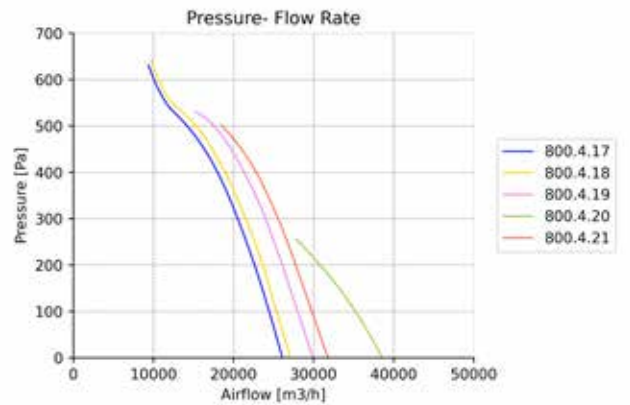

Ø900 / 6 Blade

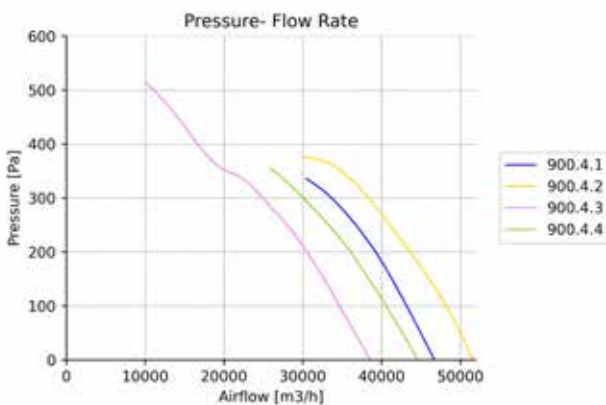

Ø900 / 8 Blade

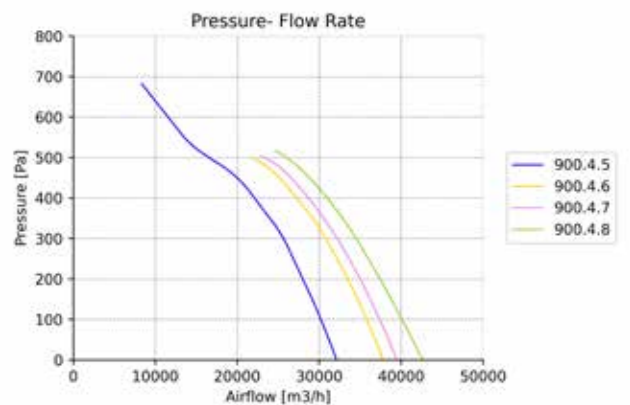

DRAGONFLY T - SYSTEM CURVE - 4 POLES

Ø900 / 9 Blade

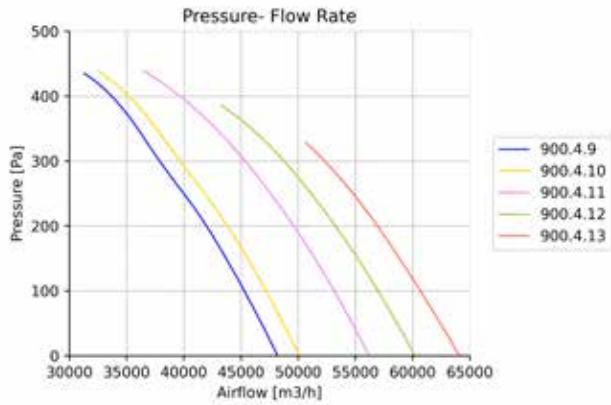

Ø900 / 12 Blade

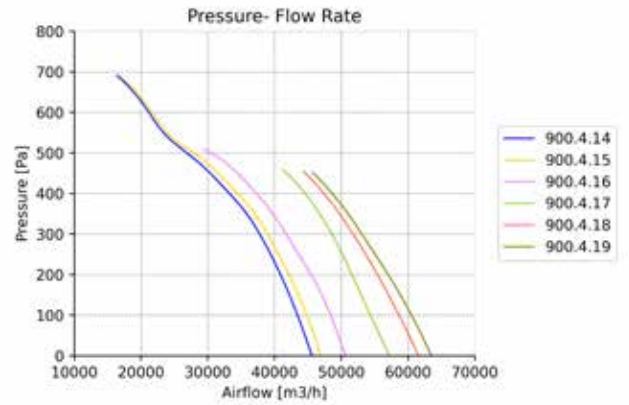

Ø900 / 6 Blade

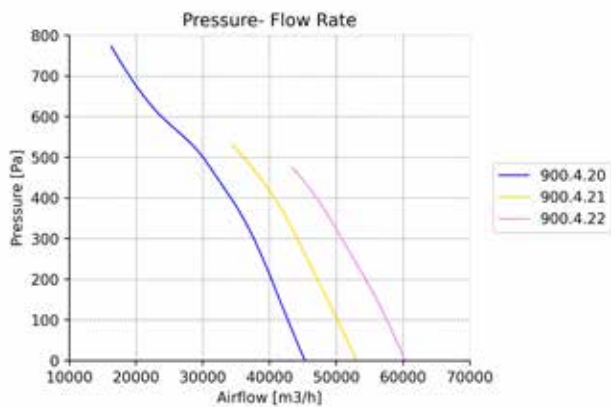

Ø1000 / 3 Blade

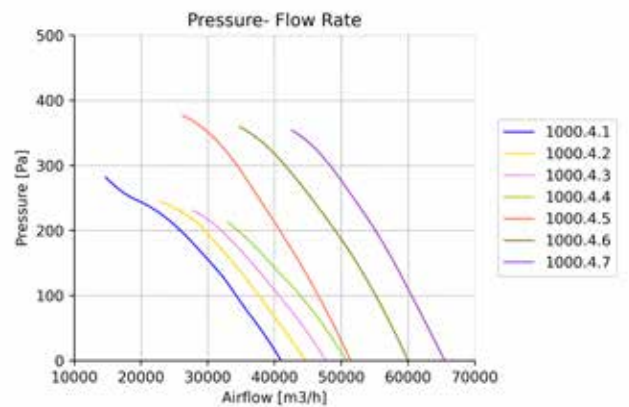

Ø1000 / 5-6 Blade

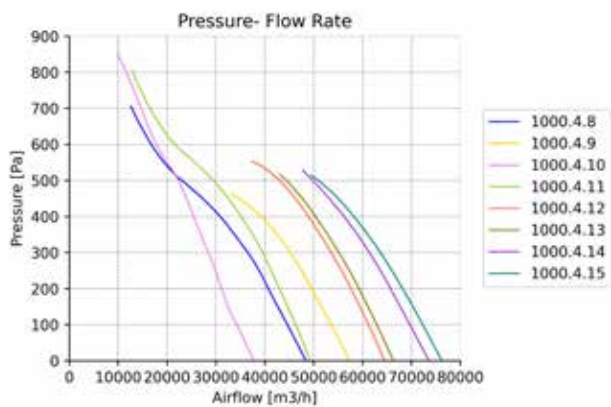

Ø1000 / 6 Blade

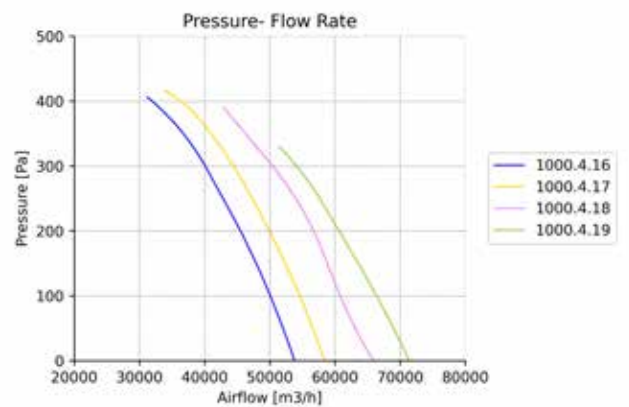

DRAGONFLY T - SYSTEM CURVE - 4 POLES

Ø1000 / 6 Blade

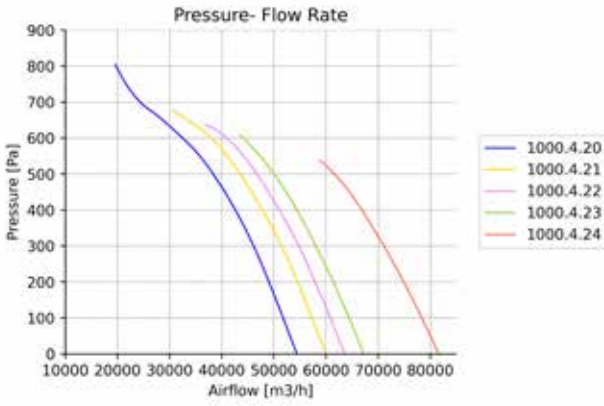

Ø1000 / 8 Blade

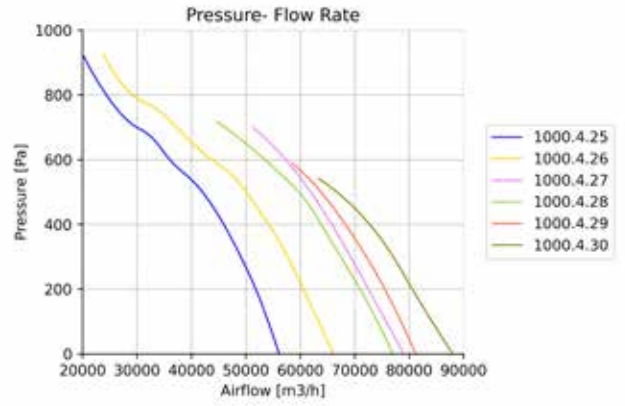

Ø1000 / 9 Blade

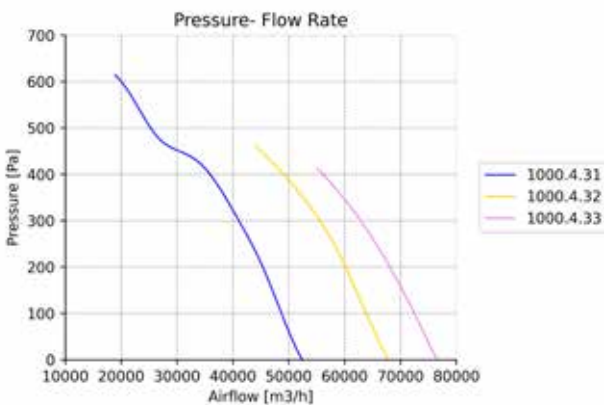

Ø1000 / 10 Blade

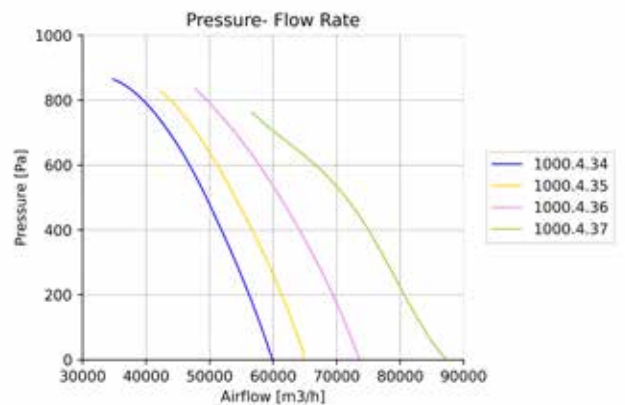

Ø1120 / 3 Blade

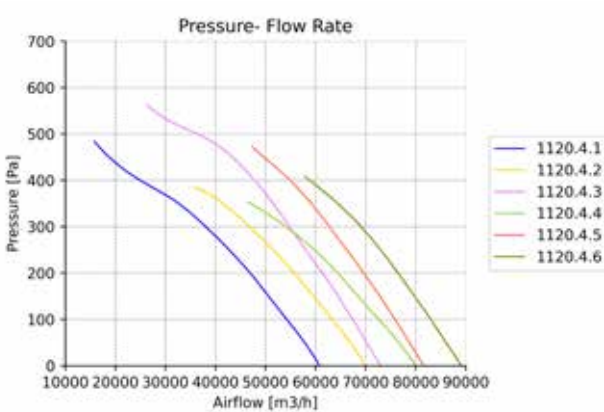

Ø1120 / 6 Blade

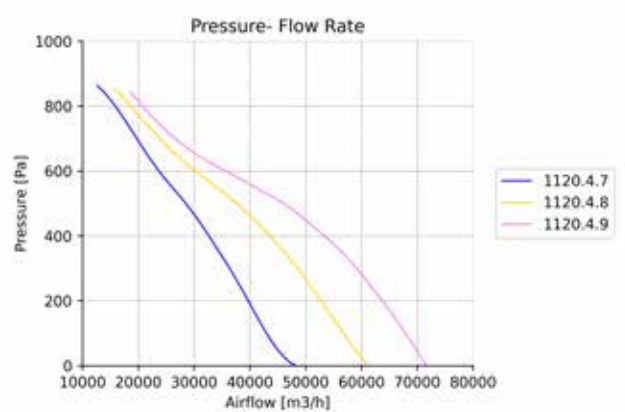

DRAGONFLY T - SYSTEM CURVE - 4 POLES

Ø1120 / 6 Blade

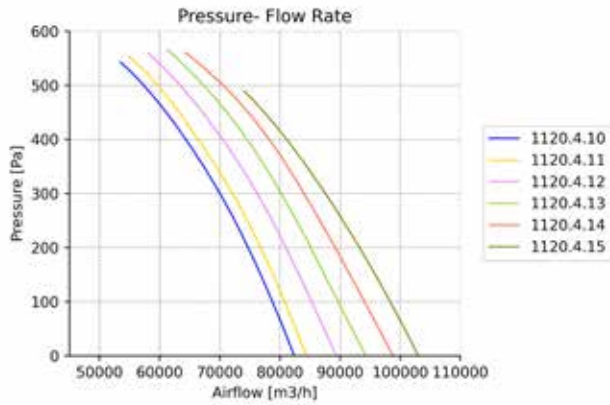

Ø1120 / 6 Blade

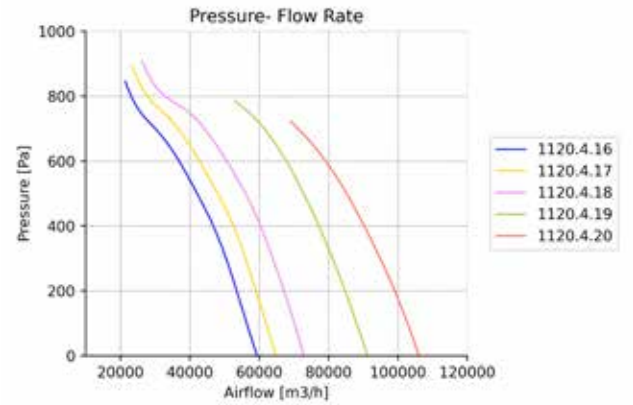

Ø1120 / 8 Blade

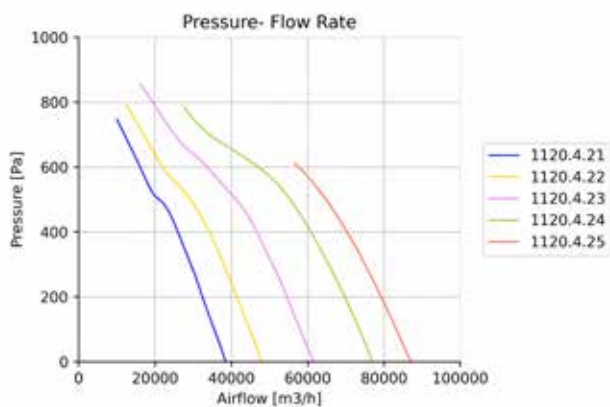

Ø1120 / 8 Blade

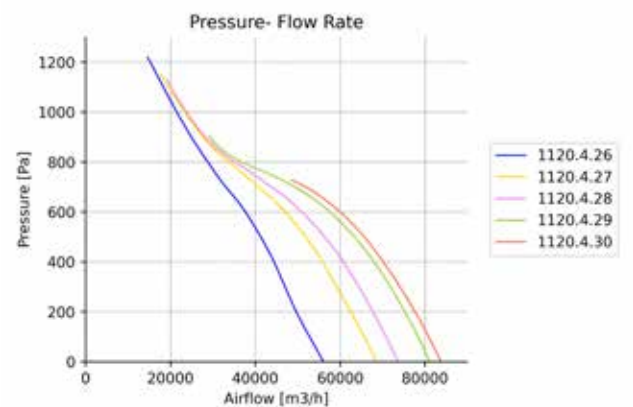

Ø1120 / 8 Blade

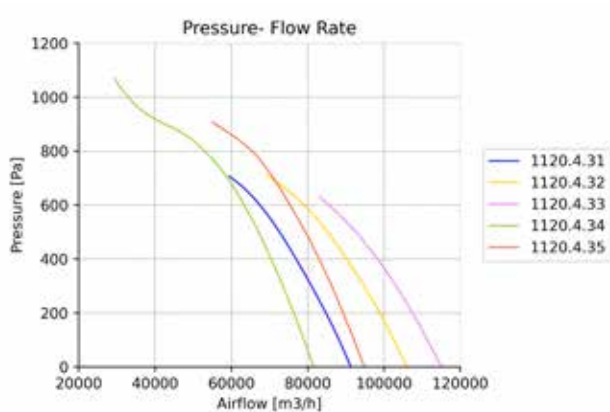

Ø1120 / 10-12 Blade

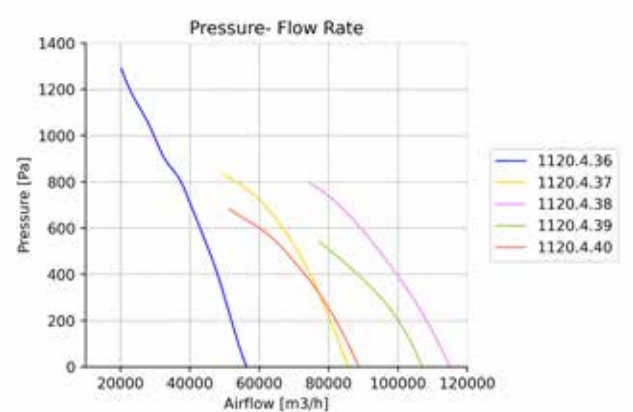

DRAGONFLY T - SYSTEM CURVE - 4 POLES

Ø1250 / 3 Blade

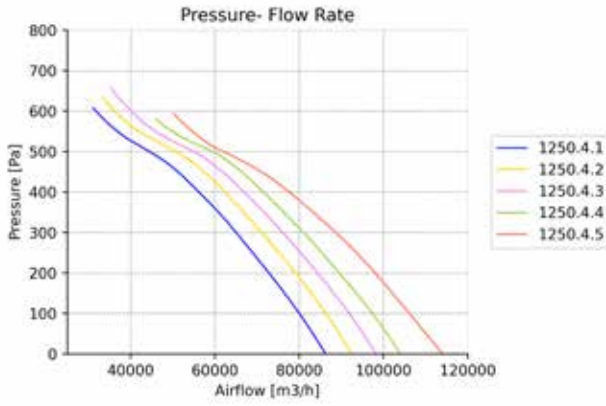

Ø1250 / 6 Blade

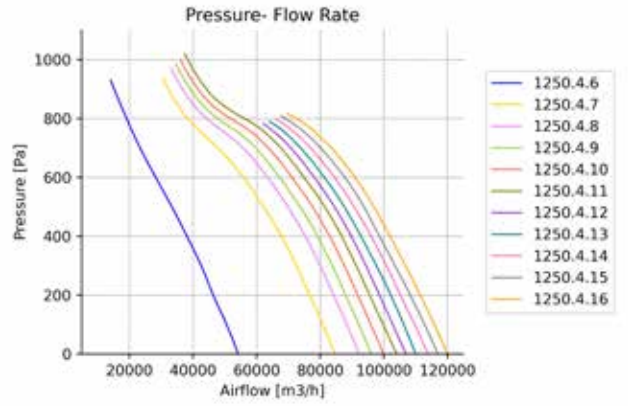

Ø1250 / 6 Blade

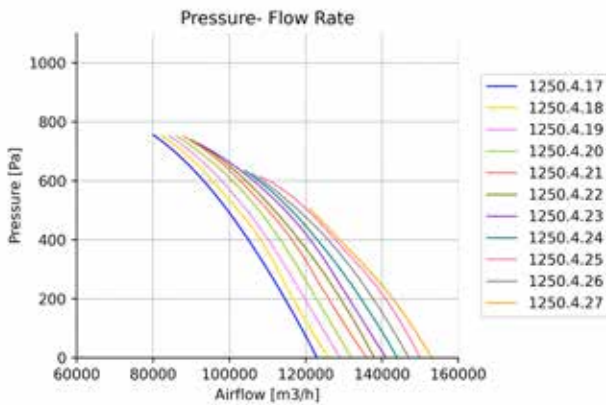

Ø1250 / 8 Blade

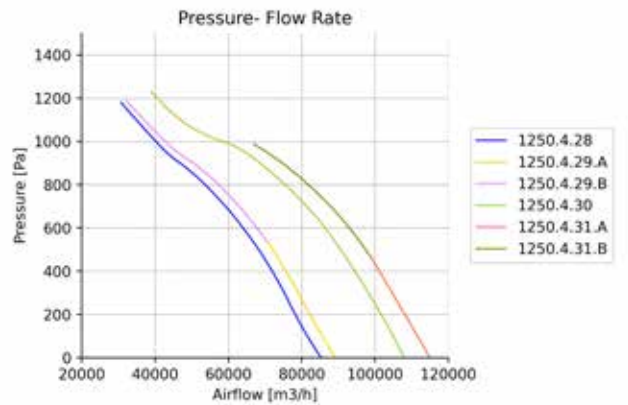

Ø1250 / 8 Blade

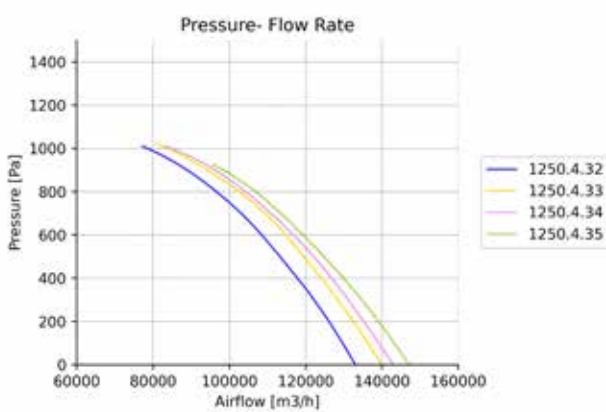

Ø1250 / 5 Blade

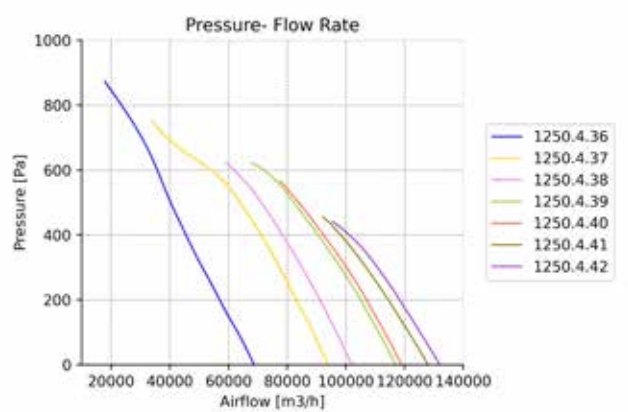

DRAGONFLY T - SYSTEM CURVE - 4 POLES

Ø1400 / 4-5-6 Blade

Ø1400 / 5-6-10 Blade

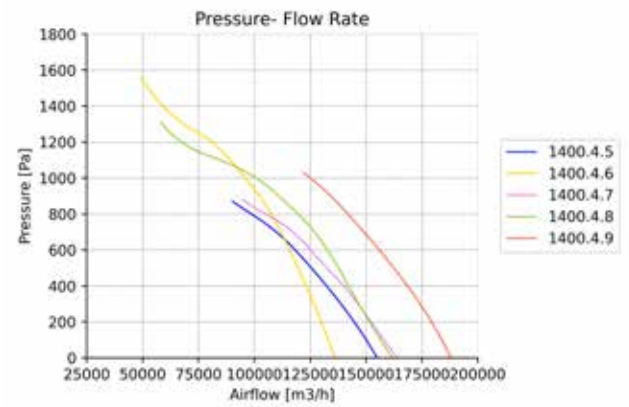
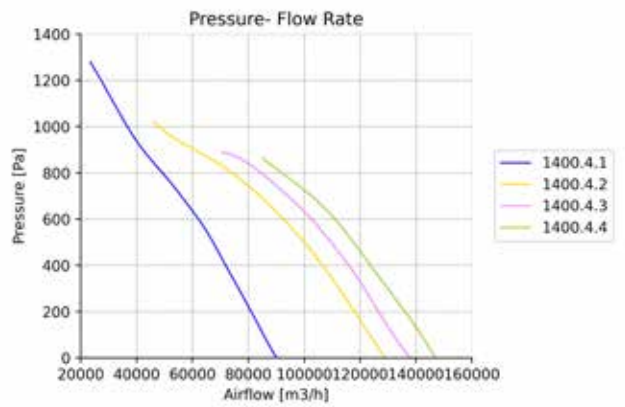

PRODUCT DIMENSIONS

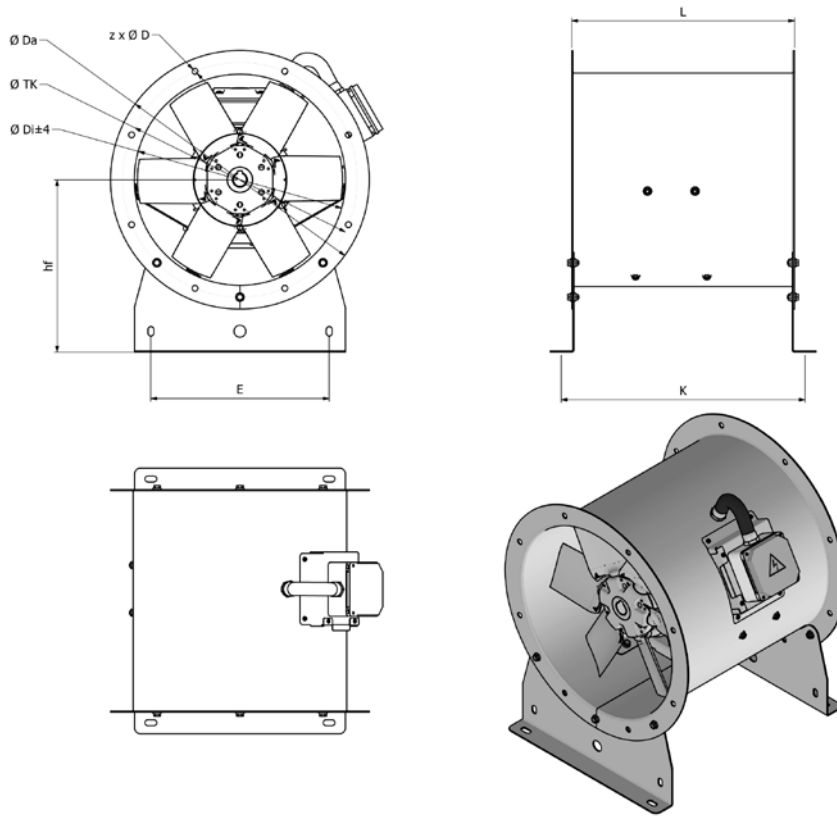

ØDi	2 Poles	4 Poles	ØTK	ØDa	z x ØD	L	E	K	hf
315	0,37--0,55	0,37	355	395	8 x 10	375	260	410	270
315	0,75--1,1	0,55--0,75	355	395	8 x 10	375	260	410	270
355	0,37--0,55	0,37	395	435	8 x 10	400	300	435	290
355	0,75--1,1	0,55--0,75	395	435	8 x 10	400	300	435	290
355	1,5--2,2	1,1--1,5	395	435	8 x 10	400	300	435	290
400	0,75--1,1	0,55--0,75	450	480	8 x 12	400	345	435	315
400	1,5--2,2	1,1--1,5	450	480	8 x 12	520	345	555	315
400	3	2,2--3	450	480	8 x 12	520	345	555	315
450	0,37--0,55	0,37	500	530	8 x 12	450	395	485	340
450	0,75--1,1	0,55--0,75	500	530	8 x 12	450	395	485	340
450	1,5--2,2	1,1--1,5	500	530	8 x 12	570	395	605	340
450	3	2,2--3	500	530	8 x 12	570	395	605	340
450	4	4	500	530	8 x 12	640	395	675	340
450	5,5--7,5	5,5--7,5	500	530	8 x 12	640	395	675	340
500	0,37--0,55	0,37	560	590	12 x 12	450	440	490	390
500	0,75--1,1	0,55--0,75	560	590	12 x 12	450	440	490	390
500	1,5--2,2	1,1--1,5	560	590	12 x 12	570	440	610	390
500	3	2,2--3	560	590	12 x 12	570	440	610	390
500	4	4	560	590	12 x 12	640	440	680	390
500	5,5--7,5	5,5--7,5	560	590	12 x 12	640	440	680	390

ØDi	2 Poles	4 Poles	ØTK	ØDa	z x ØD	L	E	K	hf
560	0,37--0,55	0,37	620	650	12 x 12	570	500	610	420
560	0,75--1,1	0,55--0,75	620	650	12 x 12	570	500	610	420
560	1,5--2,2	1,1--1,5	620	650	12 x 12	570	500	610	420
560	3	2,2--3	620	650	12 x 12	570	500	610	420
560	4	4	620	650	12 x 12	640	500	680	420
560	5,5--7,5	5,5--7,5	620	650	12 x 12	640	500	680	420
560	15--18,5	11--15	620	650	12 x 12	750	500	790	420
630	0,37--0,55	0,37	690	720	12 x 12	570	570	610	455
630	0,75--1,1	0,55--0,75	690	720	12 x 12	570	570	610	455
630	1,5--2,2	1,1--1,5	690	720	12 x 12	570	570	610	455
630	3	2,2--3	690	720	12 x 12	570	570	610	455
630	4	4	690	720	12 x 12	640	570	680	455
630	5,5--7,5	5,5--7,5	690	720	12 x 12	640	570	680	455
630	15--18,5	11--15	690	720	12 x 12	750	570	790	455
710	0,75--1,1	0,55--0,75	770	800	16 x 12	570	650	620	525
710	1,5--2,2	1,1--1,5	770	800	16 x 12	570	650	620	525
710	3	2,2--3	770	800	16 x 12	570	650	620	525
710	4	4	770	800	16 x 12	640	650	690	525
710	5,5--7,5	5,5--7,5	770	800	16 x 12	640	650	690	525
710	15--18,5	11--15	770	800	16 x 12	850	650	900	525
710	22	18,5--22	770	800	16 x 12	850	650	900	525
710	30--37	30--37	770	800	16 x 12	850	650	900	525
800	0,75--1,1	0,55--0,75	860	890	16 x 12	570	730	620	570
800	1,5--2,2	1,1--1,5	860	890	16 x 12	570	730	620	570
800	3	2,2--3	860	890	16 x 12	570	730	620	570
800	4	4	860	890	16 x 12	700	730	750	570
800	5,5--7,5	5,5--7,5	860	890	16 x 12	700	730	750	570
800	15--18,5	11--15	860	890	16 x 12	850	730	900	570
800	22	18,5--22	860	890	16 x 12	850	730	900	570
800	30--37	30--37	860	890	16 x 12	850	730	900	570
900	-	0,55--0,75	970	1005	16 x 15	570	830	620	620
900	-	1,1--1,5	970	1005	16 x 15	570	830	620	620
900	-	2,2--3	970	1005	16 x 15	570	830	620	620
900	-	4	970	1005	16 x 15	700	830	750	620
900	-	5,5--7,5	970	1005	16 x 15	700	830	750	620
900	-	11--15	970	1005	16 x 15	850	830	900	620
900	-	18,5--22	970	1005	16 x 15	850	830	900	620
900	-	30--37	970	1005	16 x 15	850	830	900	620
1000	-	0,55--0,75	1070	1105	16 x 15	570	930	620	670
1000	-	1,1--1,5	1070	1105	16 x 15	570	930	620	670
1000	-	2,2--3	1070	1105	16 x 15	570	930	620	670
1000	-	4	1070	1105	16 x 15	700	930	750	670
1000	-	5,5--7,5	1070	1105	16 x 15	700	930	750	670

SMOKE AND HEAT EXTRACT FAN

ØDi	2 Poles	4 Poles	ØTK	ØDa	z x ØD	L	E	K	hf
1000	-	11--15	1070	1105	16 x 15	950	930	1000	670
1000	-	18,5--22	1070	1105	16 x 15	950	930	1000	670
1000	-	30--37	1070	1105	16 x 15	950	930	1000	670
1000	-	45--55	1070	1105	16 x 15	950	930	1000	670
1120	-	4	1190	1260	20 x 15	750	1020	812	764
1120	-	5,5--7,5	1190	1260	20 x 15	750	1020	812	764
1120	-	11--15	1190	1260	20 x 15	800	1020	862	764
1120	-	18,5--22	1190	1260	20 x 15	800	1020	862	764
1120	-	30--37	1190	1260	20 x 15	950	1020	1012	764
1120	-	45--55	1190	1260	20 x 15	950	1020	1012	764
1250	-	4	1320	1390	20 x 15	700	1150	760	825
1250	-	5,5--7,5	1320	1390	20 x 15	700	1150	760	825
1250	-	11--15	1320	1390	20 x 15	800	1150	860	825
1250	-	18,5--22	1320	1390	20 x 15	800	1150	860	825
1250	-	30--37	1320	1390	20 x 15	1000	1150	1060	825
1250	-	45--55	1320	1390	20 x 15	1000	1150	1060	825
1250	-	75	1320	1390	20 x 15	1000	1150	1060	825
1400	-	5,5--7,5	1470	1540	20 x 15	750	1300	810	900
1400	-	11--15	1470	1540	20 x 15	900	1300	960	900
1400	-	18,5--22	1470	1540	20 x 15	900	1300	960	900
1400	-	30--37	1470	1540	20 x 15	1120	1300	1180	900
1400	-	45--55	1470	1540	20 x 15	1120	1300	1180	900
1400	-	75	1470	1540	20 x 15	1120	1300	1180	900
1400	-	90	1470	1540	20 x 15	1120	1300	1180	900

TECHNICAL PARAMETERS

MODEL	MODEL NUMBER	Voltage Frequency	Motor Power	Current	Rotation Speed	Sound Pressure	Protection Class	Working Range	Mass
		V-Hz	kW	A	RPM	Lp(A) dB at 3m	IP	°C	~ Kg
DF315F3-TAA1U-2T0,75	315.2.1	400-50	0,75	1,5	2880	59,1	55	300	27
DF315F3-TAA2U-2T0,75	315.2.2	400-50	0,75	1,5	2880	62,3	55	300	27
DF315F3-TAA3U-2T0,75	315.2.3	400-50	0,75	1,5	2880	62	55	300	27
DF315F3-TAA4U-2T0,75	315.2.4	400-50	0,75	1,5	2880	64	55	300	27
DF315F3-TAA5U-2T0,75	315.2.5	400-50	0,75	1,6	2880	65,3	55	300	27
DF315F3-TAA6U-2T0,75	315.2.6	400-50	0,75	1,6	2880	65,3	55	300	27
DF315F3-TAA7U-2T0,75	315.2.7	400-50	0,75	1,5	2880	64,1	55	300	27
DF315F3-TAA8U-2T0,75	315.2.8	400-50	0,75	1,5	2880	65,1	55	300	27
DF315F3-TAA9U-2T0,75	315.2.9	400-50	0,75	1,6	2880	61,1	55	300	27
DF315F3-TAA10U-2T0,75	315.2.10	400-50	0,75	1,6	2880	61,6	55	300	27
DF315F3-TAA11U-2T0,75	315.2.11	400-50	0,75	1,7	2880	62,9	55	300	27
DF315F3-TAA12U-2T1,1	315.2.12	400-50	1,1	2,3	2880	64,1	55	300	29
DF355F3-TAA1U-2T0,75	355.2.1	400-50	0,75	1,5	2880	60,1	55	300	29
DF355F3-TAA2U-2T0,75	355.2.2	400-50	0,75	1,5	2880	58,2	55	300	29
DF355F3-TAA3U-2T0,75	355.2.3	400-50	0,75	1,6	2880	60,9	55	300	29
DF355F3-TAA4U-2T0,75	355.2.4	400-50	0,75	1,6	2880	62,2	55	300	29
DF355F3-TAA5U-2T0,75	355.2.5	400-50	0,75	1,7	2880	64,1	55	300	29
DF355F3-TAA6U-2T0,75	355.2.6	400-50	0,75	1,6	2880	62,6	55	300	29
DF355F3-TAA7U-2T0,75	355.2.7	400-50	0,75	1,6	2880	65,9	55	300	30
DF355F3-TAA8U-2T0,75	355.2.8	400-50	0,75	1,7	2880	61,5	55	300	29
DF355F3-TAA9U-2T0,75	355.2.9	400-50	0,75	1,7	2880	62,1	55	300	29
DF355F3-TAA10U-2T1,1	355.2.10	400-50	1,1	2,3	2880	62,4	55	300	31
DF355F3-TAA11U-2T0,75	355.2.11	400-50	0,75	1,7	2880	63,2	55	300	29
DF355F3-TAA12U-2T1,5	355.2.12	400-50	1,5	3,3	2880	65,8	55	300	36
DF400F3-TAA1U-2T0,75	400.2.1	400-50	0,75	1,5	2880	64,5	55	300	31
DF400F3-TAA2U-2T0,75	400.2.2	400-50	0,75	1,6	2880	62,5	55	300	31
DF400F3-TAA3U-2T0,75	400.2.3	400-50	0,75	1,7	2880	63,8	55	300	31
DF400F3-TAA4U-2T0,75	400.2.4	400-50	0,75	1,7	2880	64,6	55	300	31
DF400F3-TAA5U-2T1,1	400.2.5	400-50	1,1	2,3	2880	67,2	55	300	35
DF400F3-TAA6U-2T1,1	400.2.6	400-50	1,1	2,3	2880	64,5	55	300	35
DF400F3-TAA7U-2T1,5	400.2.7	400-50	1,5	3,3	2880	67	55	300	39
DF400F3-TAA8U-2T2,2	400.2.8	400-50	2,2	4,5	2880	69,4	55	300	42
DF400F3-TAA9U-2T0,75	400.2.9	400-50	0,75	1,7	2880	67,6	55	300	31
DF400F3-TAA10U-2T0,75	400.2.10	400-50	0,75	1,7	2880	65,6	55	300	31
DF400F3-TAA11U-2T1,1	400.2.11	400-50	1,1	2,3	2880	64,2	55	300	35
DF400F3-TAA12U-2T1,5	400.2.12	400-50	1,5	3,3	2880	65,4	55	300	40
DF400F3-TAA13U-2T1,5	400.2.13	400-50	1,5	3,3	2880	65,2	55	300	40
DF400F3-TAA14U-2T2,2	400.2.14	400-50	2,2	4,5	2880	65,5	55	300	42
DF400F3-TAA15U-2T3	400.2.15	400-50	3	5,9	2880	68,3	55	300	51
DF450F3-TAA1U-2T0,75	450.2.1	400-50	0,75	1,6	2880	68	55	300	34
DF450F3-TAA2U-2T0,75	450.2.2	400-50	0,75	1,7	2880	71,9	55	300	34
DF450F3-TAA3U-2T1,1	450.2.3	400-50	1,1	2,3	2880	66,9	55	300	39
DF450F3-TAA4U-2T1,1	450.2.4	400-50	1,1	2,3	2880	68,3	55	300	39
DF450F3-TAA5U-2T1,1	450.2.5	400-50	1,1	2,3	2880	72	55	300	39
DF450F3-TAA6U-2T1,5	450.2.6	400-50	1,5	3,3	2880	66,3	55	300	43
DF450F3-TAA7U-2T2,2	450.2.7	400-50	2,2	4,5	2880	69,4	55	300	45

MODEL	MODEL NUMBER	Voltage Frequency	Motor Power	Current	Rotation Speed	Sound Pressure	Protection Class	Working Range	Mass
		V-Hz	kW	A	RPM	Lp(A) dB at 3m	IP	°C	~ Kg
DF450F3-TAA8U-2T1,5	450.2.8	400-50	1,5	3,3	2880	71,3	55	300	44
DF450F3-TAA9U-2T2,2	450.2.9	400-50	2,2	4,5	2880	69,6	55	300	46
DF450F3-TAA10U-2T2,2	450.2.10	400-50	2,2	4,5	2880	68,9	55	300	46
DF450F3-TAA11U-2T3	450.2.11	400-50	3	5,9	2880	70	55	300	55
DF450F3-TAA12U-2T4	450.2.12	400-50	4	7,9	2880	73,2	55	300	61
DF450F3-TAA13U-2T3	450.2.13	400-50	3	5,9	2880	68,4	55	300	55
DF450F3-TAA14U-2T3	450.2.14	400-50	3	5,9	2880	68,4	55	300	55
DF450F3-TAA15U-2T5,5	450.2.15	400-50	5,5	10,3	2880	69,7	55	300	77
DF500F3-TAA1U-2T0,75	500.2.1	400-50	0,75	1,7	2880	75,3	55	300	47
DF500F3-TAA2U-2T1,1	500.2.2	400-50	1,1	2,3	2880	69,8	55	300	53
DF500F3-TAA3U-2T1,5	500.2.3	400-50	1,5	3,3	2880	71,2	55	300	58
DF500F3-TAA4U-2T2,2	500.2.4	400-50	2,2	4,5	2880	69,4	55	300	60
DF500F3-TAA5U-2T2,2	500.2.6	400-50	2,2	4,5	2880	68,9	55	300	60
DF500F3-TAA6U-2T2,2	500.2.5	400-50	2,2	4,5	2880	65,8	55	300	60
DF500F3-TAA7U-2T3	500.2.7	400-50	3	5,9	2880	69,4	55	300	69
DF500F3-TAA8U-2T3	500.2.8	400-50	3	5,9	2880	73	55	300	69
DF500F3-TAA9U-2T4	500.2.9	400-50	4	7,9	2880	73,5	55	300	76
DF500F3-TAA10U-2T4	500.2.10	400-50	4	7,9	2880	71,2	55	300	76
DF500F3-TAA11U-2T5,5	500.2.11	400-50	5,5	10,3	2880	70,9	55	300	92
DF500F3-TAA12U-2T7,5	500.2.12	400-50	7,5	13,6	2880	71,7	55	300	97
DF500F3-TAA13U-2T7,5	500.2.13	400-50	7,5	13,6	2880	71,7	55	300	97
DF560F3-TAA1U-2T0,75	560.2.1	400-50	0,75	1,7	2880	71,7	55	300	56
DF560F3-TAA2U-2T1,1	560.2.2	400-50	1,1	2,3	2880	69,4	55	300	57
DF560F3-TAA3U-2T1,5	560.2.3	400-50	1,5	3,3	2880	72,7	55	300	62
DF560F3-TAA4U-2T2,2	560.2.4	400-50	2,2	5,9	2880	73	55	300	65
DF560F3-TAA5U-2T4	560.2.5	400-50	4	7,9	2880	71,7	55	300	80
DF560F3-TAA6U-2T4	560.2.6	400-50	4	7,9	2880	72,8	55	300	80
DF560F3-TAA7U-2T5,5	560.2.7	400-50	5,5	10,3	2880	74,6	55	300	96
DF560F3-TAA8U-2T3	560.2.8	400-50	3	5,9	2880	71,7	55	300	74
DF560F3-TAA9U-2T4	560.2.9	400-50	4	7,9	2880	72,2	55	300	81
DF560F3-TAA10U-2T5,5	560.2.10	400-50	5,5	10,3	2880	72,5	55	300	97
DF560F3-TAA11U-2T7,5	560.2.11	400-50	7,5	13,6	2880	74,3	55	300	102
DF560F3-TAA12U-2T4	560.2.12	400-50	4	7,9	2880	73,3	55	300	81
DF560F3-TAA13U-2T5,5	560.2.13	400-50	5,5	10,3	2880	74,7	55	300	97
DF560F3-TAA14U-2T7,5	560.2.14	400-50	7,5	13,6	2880	73,4	55	300	102
DF560F3-TAA15U-2T11	560.2.15	400-50	11	19,5	2880	74,1	55	300	157
DF560F3-TAA16U-2T11	560.2.16	400-50	11	19,5	2880	73,8	55	300	157
DF630F3-TAA1U-2T2,2	630.2.1	400-50	2,2	4,5	2880	72,7	55	300	68
DF630F3-TAA2U-2T3	630.2.2	400-50	3	5,9	2880	73,8	55	300	78
DF630F3-TAA3U-2T5,5	630.2.3	400-50	5,5	10,3	2880	72,2	55	300	101
DF630F3-TAA4U-2T5,5	630.2.4	400-50	5,5	10,3	2880	74,3	55	300	101
DF630F3-TAA5U-2T7,5	630.2.5	400-50	7,5	13,6	2880	77,5	55	300	107
DF630F3-TAA6U-2T7,5	630.2.6	400-50	7,5	13,6	2880	75,4	55	300	106
DF630F3-TAA7U-2T11	630.2.7	400-50	11	19,5	2880	77,7	55	300	163
DF630F3-TAA8U-2T11	630.2.8	400-50	11	19,5	2880	75,7	55	300	162
DF630F3-TAA9U-2T7,5	630.2.9	400-50	7,5	13,6	2880	77,4	55	300	107

MODEL	MODEL NUMBER	Voltage Frequency	Motor Power	Current	Rotation Speed	Sound Pressure	Protection Class	Working Range	Mass
		V-Hz	kW	A	RPM	Lp(A) dB at 3m	IP	°C	~ Kg
DF630F3-TAA10U-2T11	630.2.10	400-50	11	19,5	2880	75,6	55	300	163
DF630F3-TAA11U-2T11	630.2.11	400-50	11	19,5	2880	75,7	55	300	163
DF630F3-TAA12U-2T15	630.2.12	400-50	15	28,3	2880	75,6	55	300	171
DF630F3-TAA13U-2T15	630.2.13	400-50	15	28,3	2880	77,7	55	300	171
DF630F3-TAA14U-2T15	630.2.14	400-50	15	28,3	2880	75,5	55	300	171
DF710F3-TAA1U-2T3	710.2.1	400-50	3	5,9	2880	78,8	55	300	85
DF710F3-TAA2U-2T5,5	710.2.2	400-50	5,5	10,3	2880	76	55	300	109
DF710F3-TAA3U-2T7,5	710.2.3	400-50	7,5	13,6	2880	76,3	55	300	114
DF710F3-TAA4U-2T7,5	710.2.4	400-50	7,5	13,6	2880	77,1	55	300	114
DF710F3-TAA5U-2T11	710.2.5	400-50	11	19,5	2880	77,9	55	300	178
DF710F3-TAA6U-2T11	710.2.6	400-50	11	19,5	2880	78,9	55	300	178
DF710F3-TAA7U-2T5,5	710.2.7	400-50	5,5	10,3	2880	86,5	55	300	109
DF710F3-TAA8.AU-2T7,5	710.2.8A	400-50	7,5	13,6	2880	82,5	55	300	114
DF710F3-TAA8.BU-2T11	710.2.8B	400-50	11	19,5	2880	82,5	55	300	178
DF710F3-TAA9U-2T15	710.2.9	400-50	15	28,3	2880	75,4	55	300	188
DF710F3-TAA10U-2T11	710.2.10	400-50	11	19,5	2880	80,5	55	300	178
DF710F3-TAA11U-2T15	710.2.11	400-50	15	28,3	2880	77,3	55	300	190
DF710F3-TAA12U-2T15	710.2.12	400-50	15	28,3	2880	80,5	55	300	186
DF710F3-TAA13U-2T18,5	710.2.13	400-50	18,5	32,3	2880	81,5	55	300	208
DF710F3-TAA14U-2T18,5	710.2.14	400-50	18,5	32,3	2880	81,5	55	300	208
DF800F3-TAA1U-2T11	800.2.1	400-50	11	19,5	2880	81,5	55	300	194
DF800F3-TAA2U-2T15	800.2.2	400-50	15	28,3	2880	82,5	55	300	202
DF800F3-TAA3U-2T18,5	800.2.3	400-50	18,5	32,3	2880	84,5	55	300	224
DF800F3-TAA4U-2T22	800.2.4	400-50	22	38,3	2880	85,5	55	300	259
DF800F3-TAA5U-2T18,5	800.2.5	400-50	18,5	32,3	2880	85,5	55	300	218
DF800F3-TAA6U-2T18,5	800.2.6	400-50	18,5	32,3	2880	85,5	55	300	218
DF800F3-TAA7U-2T22	800.2.7	400-50	22	38,3	2880	85,5	55	300	253
DF315F3-TAA1U-4T0,75	315.4.1	400-50	0,75	1,13	1440	49,1	55	300	29
DF315F3-TAA2U-4T0,75	315.4.2	400-50	0,75	1,13	1440	49,2	55	300	29
DF355F3-TAA1U-4T0,75	355.4.1	400-50	0,75	1,13	1440	46,5	55	300	31
DF355F3-TAA2U-4T0,75	355.4.2	400-50	0,75	1,13	1440	48,1	55	300	31
DF400F3-TAA1U-4T0,75	400.4.1	400-50	0,75	1,13	1440	50,5	55	300	33
DF400F3-TAA2U-4T0,75	400.4.2	400-50	0,75	1,13	1440	50,7	55	300	33
DF400F3-TAA3U-4T0,75	400.4.3	400-50	0,75	1,13	1440	51,6	55	300	33
DF450F3-TAA1U-4T0,75	450.4.1	400-50	0,75	1,13	1440	52,7	55	300	36
DF450F3-TAA2U-4T0,75	450.4.2	400-50	0,75	1,13	1440	54,6	55	300	37
DF450F3-TAA3U-4T0,75	450.4.3	400-50	0,75	1,13	1440	54,7	55	300	36
DF450F3-TAA4U-4T0,75	450.4.4	400-50	0,75	1,55	1440	53,4	55	300	37
DF450F3-TAA5U-4T0,75	450.4.5	400-50	0,75	1,13	1440	53,4	55	300	37
DF450F3-TAA6U-4T0,75	450.4.6	400-50	0,75	1,55	1440	53,4	55	300	37
DF450F3-TAA7U-4T0,75	450.4.7	400-50	0,75	2	1440	53,5	55	300	37
DF500F3-TAA1U-4T0,75	500.4.1	400-50	0,75	1,13	1440	51,7	55	300	50
DF500F3-TAA2U-4T0,75	500.4.2	400-50	0,75	1,55	1440	56,5	55	300	50
DF500F3-TAA3U-4T0,75	500.4.3	400-50	0,75	1,13	1440	57,6	55	300	49
DF500F3-TAA4U-4T0,75	500.4.4	400-50	0,75	2	1440	56,8	55	300	49
DF500F3-TAA5U-4T0,75	500.4.5	400-50	0,75	1,55	1440	57,8	55	300	50

MODEL	MODEL NUMBER	Voltage Frequency	Motor Power	Current	Rotation Speed	Sound Pressure	Protection Class	Working Range	Mass
		V-Hz	kW	A	RPM	Lp(A) dB at 3m	IP	°C	~ Kg
DF500F3-TAA6U-4T0,75	500.4.6	400-50	0,75	2	1440	57,8	55	300	50
DF500F3-TAA7U-4T1,1	500.4.7	400-50	1,1	2,6	1440	58,5	55	300	60
DF560F3-TAA1U-4T0,75	560.4.1	400-50	0,75	1,13	1440	58,6	55	300	57
DF560F3-TAA2U-4T0,75	560.4.2	400-50	0,75	1,55	1440	58,2	55	300	58
DF560F3-TAA3U-4T0,75	560.4.3	400-50	0,75	2	1440	59,5	55	300	58
DF560F3-TAA4U-4T0,75	560.4.4	400-50	0,75	2	1440	60	55	300	58
DF560F3-TAA5U-4T1,1	560.4.5	400-50	1,1	2,6	1440	59,7	55	300	63
DF560F3-TAA6U-4T0,75	560.4.6	400-50	0,75	1,13	1440	60,3	55	300	59
DF560F3-TAA7U-4T0,75	560.4.7	400-50	0,75	2	1440	59,8	55	300	59
DF560F3-TAA8U-4T1,1	560.4.8	400-50	1,1	2,6	1440	58,8	55	300	64
DF560F3-TAA9U-4T1,1	560.4.9	400-50	1,1	2,6	1440	59,3	55	300	64
DF560F3-TAA10U-4T1,5	560.4.10	400-50	1,5	3,5	1440	60,2	55	300	68
DF630F3-TAA1U-4T0,75	630.4.1	400-50	0,75	1,55	1440	60,4	55	300	63
DF630F3-TAA2U-4T0,75	630.4.2	400-50	0,75	1,55	1440	60	55	300	63
DF630F3-TAA3U-4T0,75	630.4.3	400-50	0,75	2	1440	58,2	55	300	63
DF630F3-TAA4U-4T1,1	630.4.4	400-50	1,1	2,6	1440	61,6	55	300	68
DF630F3-TAA5U-4T1,5	630.4.5	400-50	1,5	3,5	1440	62,4	55	300	72
DF630F3-TAA6U-4T1,5	630.4.6	400-50	1,5	2	1440	61,2	55	300	71
DF630F3-TAA7U-4T2,2	630.4.7	400-50	2,2	5	1440	65,1	55	300	79
DF630F3-TAA8U-4T0,75	630.4.8	400-50	0,75	2	1440	61,8	55	300	64
DF630F3-TAA9U-4T0,75	630.4.9	400-50	0,75	2	1440	67	55	300	64
DF630F3-TAA10U-4T1,1	630.4.10	400-50	1,1	2,6	1440	60,5	55	300	69
DF630F3-TAA11U-4T1,5	630.4.11	400-50	1,5	3,5	1440	60,4	55	300	72
DF630F3-TAA12U-4T1,5	630.4.12	400-50	1,5	3,5	1440	61	55	300	72
DF630F3-TAA13U-4T2,2	630.4.13	400-50	2,2	5	1440	62	55	300	80
DF630F3-TAA14U-4T2,2	630.4.14	400-50	2,2	5	1440	62,1	55	300	80
DF630F3-TAA15U-4T1,5	630.4.15	400-50	1,5	3,5	1440	65,3	55	300	74
DF630F3-TAA16U-4T2,2	630.4.16	400-50	2,2	5	1440	65,2	55	300	81
DF630F3-TAA17U-4T2,2	630.4.17	400-50	2,2	5	1440	65,1	55	300	81
DF630F3-TAA18U-4T2,2	630.4.18	400-50	2,2	5	1440	65,4	55	300	81
DF630F3-TAA19U-4T3	630.4.19	400-50	3	6,6	1440	66,8	55	300	88
DF710F3-TAA1U-4T0,75	710.4.1	400-50	0,75	2	1440	65,8	55	300	70
DF710F3-TAA2U-4T1,5	710.4.2	400-50	1,5	3,5	1440	63	55	300	78
DF710F3-TAA3U-4T1,5	710.4.3	400-50	1,5	3,5	1440	65,9	55	300	79
DF710F3-TAA4U-4T2,2	710.4.4	400-50	2,2	5	1440	66	55	300	86
DF710F3-TAA5U-4T3	710.4.5	400-50	3	6,6	1440	66,8	55	300	92
DF710F3-TAA6U-4T3	710.4.6	400-50	3	6,6	1440	67,5	55	300	92
DF710F3-TAA7U-4T3	710.4.7	400-50	3	6,6	1440	68,1	55	300	93
DF710F3-TAA8U-4T1,5	710.4.8	400-50	1,5	3,5	1440	63,8	55	300	83
DF710F3-TAA9U-4T2,2	710.4.9	400-50	2,2	5	1440	62,2	55	300	90
DF710F3-TAA10U-4T2,2	710.4.10	400-50	2,2	5	1440	67,8	55	300	88
DF710F3-TAA11U-4T3	710.4.11	400-50	3	6,6	1440	67	55	300	95
DF710F3-TAA12U-4T4	710.4.12	400-50	4	8,4	1440	67,5	55	300	109
DF710F3-TAA13U-4T4	710.4.13	400-50	4	8,4	1440	66,5	55	300	107
DF710F3-TAA14U-4T5,5	710.4.14	400-50	5,5	11,2	1440	67,5	55	300	116
DF800F3-TAA1U4T2,2	800.4.1	400-50	2,2	5	1440	70,8	55	300	95

MODEL	MODEL NUMBER	Voltage Frequency	Motor Power	Current	Rotation Speed	Sound Pressure	Protection Class	Working Range	Mass
		V-Hz	kW	A	RPM	Lp(A) dB at 3m	IP	°C	~ Kg
DF800F3-TAA2U-4T3	800.4.2	400-50	3	6,6	1440	69	55	300	102
DF800F3-TAA3U-4T3	800.4.3	400-50	3	6,6	1440	68,1	55	300	100
DF800F3-TAA4U-4T4	800.4.4	400-50	4	8,4	1440	69,1	55	300	120
DF800F3-TAA5U-4T4	800.4.5	400-50	4	8,4	1440	69,3	55	300	120
DF800F3-TAA6U-4T4	800.4.6	400-50	4	8,4	1440	68,6	55	300	119
DF800F3-TAA7U-4T5,5	800.4.7	400-50	5,5	11,2	1440	70,1	55	300	129
DF800F3-TAA8U-4T5,5	800.4.8	400-50	5,5	11,2	1440	70,8	55	300	128
DF800F3-TAA9U-4T1,5	800.4.9	400-50	1,5	3,5	1440	73,2	55	300	88
DF800F3-TAA10U-4T3	800.4.10	400-50	3	6,6	1440	72,1	55	300	102
DF800F3-TAA11U-4T4	800.4.11	400-50	4	8,4	1440	70,7	55	300	120
DF800F3-TAA12U-4T5,5	800.4.12	400-50	5,5	11,2	1440	69,7	55	300	129
DF800F3-TAA13U-4T7,5	800.4.13	400-50	7,5	15,4	1440	70,7	55	300	140
DF800F3-TAA14U-4T2,2	800.4.14	400-50	2,2	5	1440	72,3	55	300	95
DF800F3-TAA15U-4T11	800.4.15	400-50	11	21,3	1440	71,1	55	300	217
DF800F3-TAA16U-4T7,5	800.4.16	400-50	7,5	15,4	1440	70,9	55	300	140
DF800F3-TAA17U-4T11	800.4.17	400-50	11	21,3	1440	71,4	55	300	217
DF800F3-TAA18U-4T4	800.4.18	400-50	4	8,4	1440	71,8	55	300	130
DF800F3-TAA19U-4T4	800.4.19	400-50	4	8,4	1440	72	55	300	130
DF800F3-TAA20U-4T5,5	800.4.20	400-50	5,5	11,2	1440	71,5	55	300	139
DF800F3-TAA21U-4T5,5	800.4.21	400-50	5,5	11,2	1440	70,9	55	300	139
DF900F3-TAA1U-4T5,5	900.4.1	400-50	5,5	11,2	1440	76,7	55	300	139
DF900F3-TAA2U-4T7,5	900.4.2	400-50	7,5	15,4	1440	70,5	55	300	150
DF900F3-TAA3U-4T4	900.4.3	400-50	4	8,4	1440	70,3	55	300	129
DF900F3-TAA4U-4T5,5	900.4.4	400-50	5,5	11,2	1440	70,4	55	300	138
DF900F3-TAA5U-4T4	900.4.5	400-50	4	8,4	1440	73,9	55	300	129
DF900F3-TAA6U-4T5,5	900.4.6	400-50	5,5	11,2	1440	73,1	55	300	138
DF900F3-TAA7U-4T7,5	900.4.7	400-50	7,5	15,4	1440	73,2	55	300	149
DF900F3-TAA8U-4T7,5	900.4.8	400-50	7,5	15,4	1440	71,7	55	300	149
DF900F3-TAA9U-4T7,5	900.4.9	400-50	7,5	15,4	1440	72,5	55	300	149
DF900F3-TAA10U-4T7,5	900.4.10	400-50	7,5	15,4	1440	73,2	55	300	149
DF900F3-TAA11U-4T11	900.4.11	400-50	11	21,3	1440	72,8	55	300	224
DF900F3-TAA12U-4T11	900.4.12	400-50	11	21,3	1440	72,9	55	300	224
DF900F3-TAA13U-4T15	900.4.13	400-50	15	29,8	1440	72	55	300	235
DF900F3-TAA14U-4T7,5	900.4.14	400-50	7,5	15,4	1440	73,1	55	300	153
DF900F3-TAA15U-4T7,5	900.4.15	400-50	7,5	15,4	1440	75,9	55	300	153
DF900F3-TAA16U-4T11	900.4.16	400-50	11	21,3	1440	77,8	55	300	228
DF900F3-TAA17U-4T15	900.4.17	400-50	15	29,8	1440	73,7	55	300	240
DF900F3-TAA18U-4T15	900.4.18	400-50	15	29,8	1440	73,5	55	300	240
DF900F3-TAA19U-4T15	900.4.19	400-50	15	29,8	1440	74,3	55	300	240
DF900F3-TAA20U-4T11	900.4.20	400-50	11	21,3	1440	73,4	55	300	234
DF900F3-TAA21U-4T11	900.4.21	400-50	11	21,3	1440	73,4	55	300	234
DF900F3-TAA22U-4T15	900.4.22	400-50	15	29,8	1440	71,6	55	300	245
DF1000F3-TAA1U-4T3	1000.4.1	400-50	3	6,6	1440	70,1	55	300	137
DF1000F3-TAA2U-4T3	1000.4.2	400-50	3	6,6	1440	71	55	300	137
DF1000F3-TAA3U-4T4	1000.4.3	400-50	4	8,4	1440	71,7	55	300	161
DF1000F3-TAA4U-4T4	1000.4.4	400-50	4	8,4	1440	72,5	55	300	161

MODEL	MODEL NUMBER	Voltage Frequency	Motor Power	Current	Rotation Speed	Sound Pressure	Protection Class	Working Range	Mass
		V-Hz	kW	A	RPM	Lp(A) dB at 3m	IP	°C	~ Kg
DF1000F3-TAA5U-4T5,5	1000.4.5	400-50	5,5	11,2	1440	72,4	55	300	178
DF1000F3-TAA6U-4T7,5	1000.4.6	400-50	7,5	15,4	1440	75,7	55	300	189
DF1000F3-TAA7U-4T11	1000.4.7	400-50	11	21,3	1440	77,4	55	300	288
DF1000F3-TAA8U-4T5,5	1000.4.8	400-50	5,5	11,2	1440	71,8	55	300	180
DF1000F3-TAA9U-4T7,5	1000.4.9	400-50	7,5	15,4	1440	73,3	55	300	191
DF1000F3-TAA10U-4T5,5	1000.4.10	400-50	5,5	11,2	1440	74,9	55	300	182
DF1000F3-TAA11U-4T7,5	1000.4.11	400-50	7,5	15,4	1440	78	55	300	193
DF1000F3-TAA12U-4T11	1000.4.12	400-50	11	21,3	1440	76	55	300	288
DF1000F3-TAA13U-4T11	1000.4.13	400-50	11	21,3	1440	76,4	55	300	288
DF1000F3-TAA14U-4T15	1000.4.14	400-50	15	29,8	1440	77,8	55	300	299
DF1000F3-TAA15U-4T15	1000.4.15	400-50	15	29,8	1440	78,4	55	300	299
DF1000F3-TAA16U-4T7,5	1000.4.16	400-50	7,5	15,4	1440	75,7	55	300	184
DF1000F3-TAA17U-4T7,5	1000.4.17	400-50	7,5	15,4	1440	75,3	55	300	184
DF1000F3-TAA18U-4T11	1000.4.18	400-50	11	21,3	1440	75,3	55	300	279
DF1000F3-TAA19U-4T11	1000.4.19	400-50	11	21,3	1440	76	55	300	279
DF1000F3-TAA20U-4T11	1000.4.20	400-50	11	21,3	1440	80,5	55	300	288
DF1000F3-TAA21U-4T11	1000.4.21	400-50	11	21,3	1440	80,5	55	300	288
DF1000F3-TAA22U-4T15	1000.4.22	400-50	15	29,8	1440	79,5	55	300	299
DF1000F3-TAA23U-4T15	1000.4.23	400-50	15	29,8	1440	78,4	55	300	299
DF1000F3-TAA24U-4T22	1000.4.24	400-50	22	42,5	1440	79,5	55	300	348
DF1000F3-TAA25.AU-4T11	1000.4.25.A	400-50	11	21,3	1440	73,3	55	300	293
DF1000F3-TAA25.BU-4T15	1000.4.25.B	400-50	15	29,8	1440	73,3	55	300	304
DF1000F3-TAA26U-4T15	1000.4.26	400-50	15	29,8	1440	75	55	300	304
DF1000F3-TAA27U-4T22	1000.4.27	400-50	22	42,5	1440	76,4	55	300	353
DF1000F3-TAA28U-4T30	1000.4.28	400-50	30	55	1440	79,1	55	300	393
DF1000F3-TAA29U-4T22	1000.4.29	400-50	22	42,5	1440	77,5	55	300	353
DF1000F3-TAA30U-4T30	1000.4.30	400-50	30	55	1440	77,8	55	300	390
DF1000F3-TAA31U-4T7,5	1000.4.31	400-50	7,5	15,4	1440	78,8	55	300	183
DF1000F3-TAA32U-4T11	1000.4.32	400-50	11	21,3	1440	75,9	55	300	278
DF1000F3-TAA33U-4T15	1000.4.33	400-50	15	29,8	1440	75,4	55	300	289
DF1000F3-TAA34U-4T22	1000.4.34	400-50	22	42,5	1440	82,5	55	300	348
DF1000F3-TAA35U-4T22	1000.4.35	400-50	22	42,5	1440	82,5	55	300	348
DF1000F3-TAA36U-4T30	1000.4.36	400-50	30	55	1440	81,5	55	300	385
DF1000F3-TAA37U-4T37	1000.4.37	400-50	37	67	1440	80,5	55	300	472
DF1120F3-TAA1U-4T5,5	1120.4.1	400-50	5,5	11,2	1440	75,5	55	300	204
DF1120F3-TAA2U-4T7,5	1120.4.2	400-50	7,5	15,4	1440	76,1	55	300	215
DF1120F3-TAA3U-4T11	1120.4.3	400-50	11	21,3	1440	77,6	55	300	299
DF1120F3-TAA4U-4T11	1120.4.4	400-50	11	21,3	1440	77,8	55	300	295
DF1120F3-TAA5U-4T15	1120.4.5	400-50	15	29,8	1440	79,1	55	300	310
DF1120F3-TAA6U-4T18,5	1120.4.6	400-50	18,5	34,5	1440	80,5	55	300	349
DF1120F3-TAA7U-4T7,5	1120.4.7	400-50	7,5	15,4	1440	77,1	55	300	219
DF1120F3-TAA8U-4T11	1120.4.8	400-50	11	21,3	1440	80,5	55	300	299
DF1120F3-TAA9U-4T11	1120.4.9	400-50	11	21,3	1440	79,5	55	300	299
DF1120F3-TAA10U-4T15	1120.4.10	400-50	15	29,8	1440	78,3	55	300	310
DF1120F3-TAA11U-4T15	1120.4.11	400-50	15	29,8	1440	77,8	55	300	310
DF1120F3-TAA12U-4T18,5	1120.4.12	400-50	18,5	34,5	1440	79,5	55	300	349

MODEL	MODEL NUMBER	Voltage Frequency	Motor Power	Current	Rotation Speed	Sound Pressure	Protection Class	Working Range	Mass
		V-Hz	kW	A	RPM	Lp(A) dB at 3m	IP	°C	~ Kg
DF1120F3-TAA13U-4T22	1120.4.13	400-50	22	42,5	1440	80,5	55	300	359
DF1120F3-TAA14U-4T22	1120.4.14	400-50	22	42,5	1440	81,5	55	300	359
DF1120F3-TAA15U-4T22	1120.4.15	400-50	22	42,5	1440	80,5	55	300	359
DF1120F3-TAA16U-4T11	1120.4.16	400-50	11	21,3	1440	82,5	55	300	299
DF1120F3-TAA17U-4T15	1120.4.17	400-50	15	29,8	1440	82,5	55	300	310
DF1120F3-TAA18U-4T15	1120.4.18	400-50	15	29,8	1440	82,5	55	300	310
DF1120F3-TAA19U-4T22	1120.4.19	400-50	22	42,5	1440	80,5	55	300	359
DF1120F3-TAA20U-4T30	1120.4.20	400-50	30	55	1440	83,5	55	300	411
DF1120F3-TAA21U-4T5,5	1120.4.21	400-50	5,5	11,2	1440	83,5	55	300	199
DF1120F3-TAA22U-4T7,5	1120.4.22	400-50	7,5	15,4	1440	83,5	55	300	210
DF1120F3-TAA23U-4T11	1120.4.23	400-50	11	21,3	1440	79,1	55	300	290
DF1120F3-TAA24U-4T15	1120.4.24	400-50	15	29,8	1440	78,6	55	300	301
DF1120F3-TAA25U-4T18,5	1120.4.25	400-50	18,5	34,5	1440	77,6	55	300	340
DF1120F3-TAA26U-4T11	1120.4.26	400-50	11	21,3	1440	83,5	55	300	304
DF1120F3-TAA27U-4T15	1120.4.27	400-50	15	29,8	1440	83,5	55	300	315
DF1120F3-TAA28U-4T15	1120.4.28	400-50	15	29,8	1440	82,5	55	300	315
DF1120F3-TAA29U-4T18,5	1120.4.29	400-50	18,5	34,5	1440	81,5	55	300	354
DF1120F3-TAA30U-4T18,5	1120.4.30	400-50	18,5	34,5	1440	81,5	55	300	354
DF1120F3-TAA31U-4T22	1120.4.31	400-50	22	42,5	1440	81,5	55	300	364
DF1120F3-TAA32U-4T30	1120.4.32	400-50	30	55	1440	80,5	55	300	416
DF1120F3-TAA33U-4T37	1120.4.33	400-50	37	67	1440	80,5	55	300	503
DF1120F3-TAA34U-4T22	1120.4.34	400-50	22	42,5	1440	82,5	55	300	374
DF1120F3-TAA35U-4T30	1120.4.35	400-50	30	55	1440	81,5	55	300	411
DF1120F3-TAA36U-4T15	1120.4.36	400-50	15	29,8	1440	84,5	55	300	321
DF1120F3-TAA37U-4T22	1120.4.37	400-50	22	42,5	1440	81,5	55	300	370
DF1120F3-TAA38U-4T45	1120.4.38	400-50	45	80	1440	81,5	55	300	555
DF1120F3-TAA39U-4T22	1120.4.39	400-50	22	42,5	1440	77,1	55	300	354
DF1120F3-TAA40U-4T30	1120.4.40	400-50	30	55	1440	78,1	55	300	406
DF1250F3-TAA1U-4T11	1250.4.1	400-50	11	21,3	1440	83,5	55	300	319
DF1250F3-TAA2U-4T15	1250.4.2	400-50	15	29,8	1440	82,5	55	300	330
DF1250F3-TAA3U-4T18,5	1250.4.3	400-50	18,5	34,5	1440	82,5	55	300	369
DF1250F3-TAA4U-4T18,5	1250.4.4	400-50	18,5	34,5	1440	82,5	55	300	369
DF1250F3-TAA5U-4T22	1250.4.5	400-50	22	42,5	1440	82,5	55	300	379
DF1250F3-TAA6U-4T11	1250.4.6	400-50	11	21,3	1440	87,5	55	300	319
DF1250F3-TAA7U-4T18,5	1250.4.7	400-50	18,5	34,5	1440	88,5	55	300	369
DF1250F3-TAA8U-4T22	1250.4.8	400-50	22	42,5	1440	88,5	55	300	379
DF1250F3-TAA9U-4T22	1250.4.9	400-50	22	42,5	1440	88,5	55	300	379
DF1250F3-TAA10U-4T22	1250.4.10	400-50	22	42,5	1440	88,5	55	300	379
DF1250F3-TAA11U-4T30	1250.4.11	400-50	30	55	1440	86,5	55	300	441
DF1250F3-TAA12U-4T30	1250.4.12	400-50	30	55	1440	87,5	55	300	441
DF1250F3-TAA13U-4T30	1250.4.13	400-50	30	55	1440	81,5	55	300	441
DF1250F3-TAA14U-4T30	1250.4.14	400-50	30	55	1440	87,5	55	300	441
DF1250F3-TAA15U-4T30	1250.4.15	400-50	30	55	1440	82,5	55	300	441
DF1250F3-TAA16U-4T30	1250.4.16	400-50	30	55	1440	83,5	55	300	441
DF1250F3-TAA17U-4T37	1250.4.17	400-50	37	67	1440	83,5	55	300	528
DF1250F3-TAA18U-4T37	1250.4.18	400-50	37	67	1440	83,5	55	300	528

MODEL	MODEL NUMBER	Voltage Frequency	Motor Power	Current	Rotation Speed	Sound Pressure	Protection Class	Working Range	Mass
		V-Hz	kW	A	RPM	Lp(A) dB at 3m	IP	°C	~ Kg
DF1250F3-TAA19U-4T37	1250.4.19	400-50	37	67	1440	83,5	55	300	528
DF1250F3-TAA20U-4T45	1250.4.20	400-50	45	80	1440	83,5	55	300	574
DF1250F3-TAA21U-4T45	1250.4.21	400-50	45	80	1440	83,5	55	300	574
DF1250F3-TAA22U-4T45	1250.4.22	400-50	45	80	1440	83,5	55	300	574
DF1250F3-TAA23U-4T45	1250.4.23	400-50	45	80	1440	41,5	55	300	574
DF1250F3-TAA24U-4T45	1250.4.24	400-50	45	80	1440	84,5	55	300	574
DF1250F3-TAA25U-4T55	1250.4.25	400-50	55	96,8	1440	85,5	55	300	659
DF1250F3-TAA26U-4T55	1250.4.26	400-50	55	96,8	1440	85,5	55	300	659
DF1250F3-TAA27U-4T55	1250.4.27	400-50	55	96,8	1440	85,5	55	300	659
DF1250F3-TAA28U-4T22	1250.4.28	400-50	22	42,5	1440	88,5	55	300	379
DF1250F3-TAA29.AU-4T22	1250.4.29.A	400-50	22	42,5	1440	88,5	55	300	379
DF1250F3-TAA29.BU-4T30	1250.4.29.B	400-50	30	55	1440	88,5	55	300	441
DF1250F3-TAA30U-4T30	1250.4.30	400-50	30	55	1440	86,5	55	300	441
DF1250F3-TAA31U-4T30	1250.4.31	400-50	30	55	1440	86,5	55	300	441
DF1250F3-TAA32U-4T45	1250.4.32	400-50	45	80	1440	84,5	55	300	574
DF1250F3-TAA33U-4T55	1250.4.33	400-50	55	96,8	1440	83,5	55	300	659
DF1250F3-TAA34U-4T55	1250.4.34	400-50	55	96,8	1440	83,5	55	300	659
DF1250F3-TAA35U-4T55	1250.4.35	400-50	55	96,8	1440	83,5	55	300	659
DF1250F3-TAA36U-4T11	1250.4.36	400-50	11	21,3	1440	76,5	55	300	324
DF1250F3-TAA37U-4T18,5	1250.4.37	400-50	18,5	34,5	1440	78,8	55	300	374
DF1250F3-TAA38U-4T22	1250.4.38	400-50	22	42,5	1440	79,4	55	300	384
DF1250F3-TAA39U-4T30	1250.4.39	400-50	30	55	1440	84,5	55	300	446
DF1250F3-TAA40U-4T30	1250.4.40	400-50	30	55	1440	85,5	55	300	446
DF1250F3-TAA41U-4T37	1250.4.41	400-50	37	67	1440	82,5	55	300	533
DF1250F3-TAA42U-4T37	1250.4.42	400-50	37	67	1440	83,5	55	300	533
DF1400F3-TAA1U-4T22	1400.4.1	400-50	22	42,5	1440	96,5	55	300	428
DF1400F3-TAA2U-4T30	1400.4.2	400-50	30	55	1440	90,5	55	300	498
DF1400F3-TAA3U-4T37	1400.4.3	400-50	37	67	1440	83,5	55	300	579
DF1400F3-TAA4U-4T45	1400.4.4	400-50	45	80	1440	84,5	55	300	625
DF1400F3-TAA5U-4T45	1400.4.5	400-50	45	80	1440	84,5	55	300	625
DF1400F3-TAA6U-4T55	1400.4.6	400-50	55	96,8	1440	88,5	55	300	710
DF1400F3-TAA7U-4T55	1400.4.7	400-50	55	96,8	1440	84,5	55	300	710
DF1400F3-TAA8U-4T55	1400.4.8	400-50	55	96,8	1440	85,5	55	300	713
DF1400F3-TAA9U-4T75	1400.4.9	400-50	75	132	1440	87,5	55	300	873



SMOKE AND HEAT EXTRACT ROOF FANS



- Body is electrostatic powder painted for resistance to corrosion, optional hot dip galvanized sheet
- Double speed motor option,
- Adjustable blade angle
- Dynamically balanced aluminum impeller with heat treated high temperature resistance in accordance with ISO 1940
- Suitable for horizontal and vertical mounting
- Rotational speed can be set with frequency inverter
- Resistant to 300 degrees for 2 hours according to EN 12101-3 (No 2184-CPR-0031)

DRAGONFLY R - SYSTEM CURVE - 2 POLES

Ø400 / 3-4-5 Blade

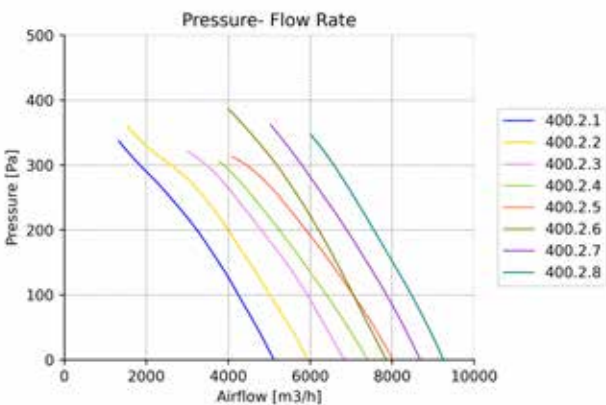

Ø400 / 6-8-10 Blade

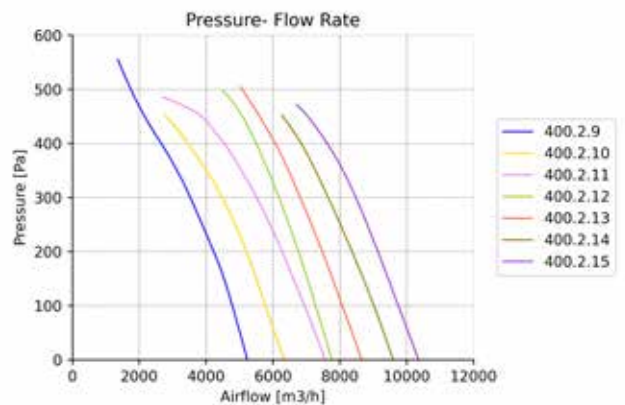

Ø450 / 3-4-6 Blade

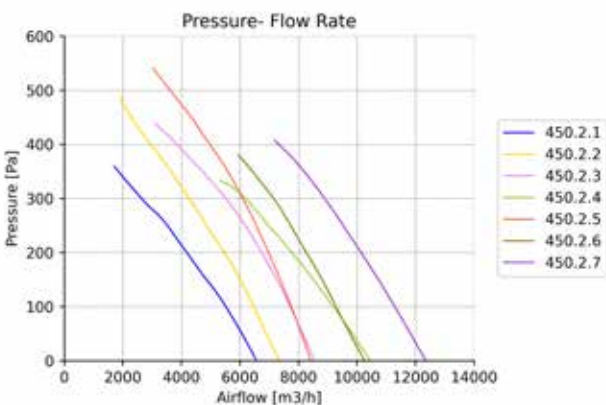

Ø450 / 5-6-8 Blade

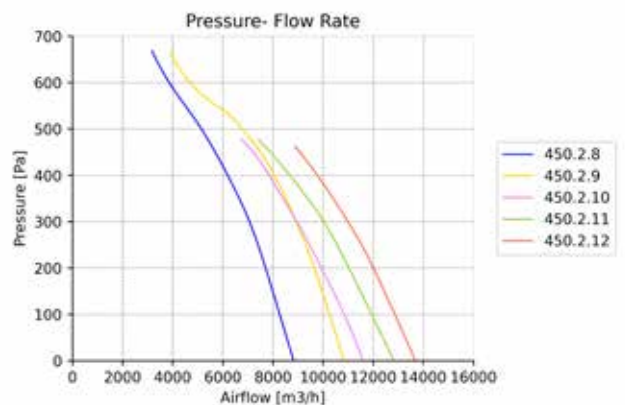

DRAGONFLY R - SYSTEM CURVE - 2 POLES

Ø450 / 10 Blade

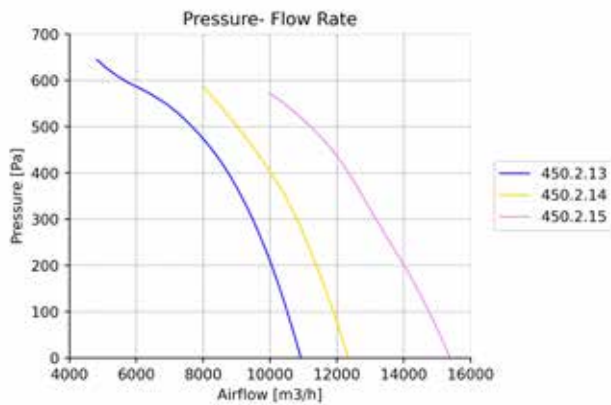

Ø500 / 3-4 Blade

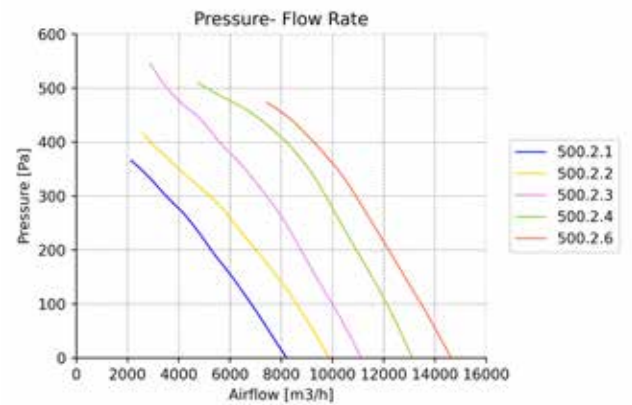

Ø500 / 5 Blade

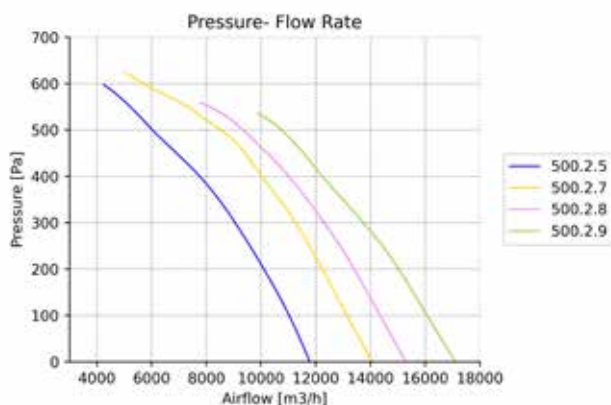

Ø500 / 10 Blade

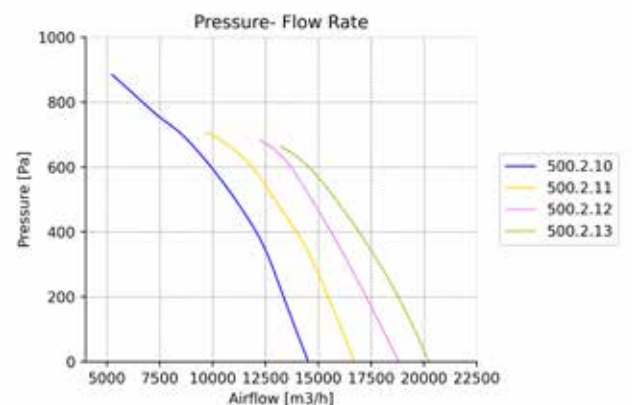

Ø560 / 3-4-5 Blade

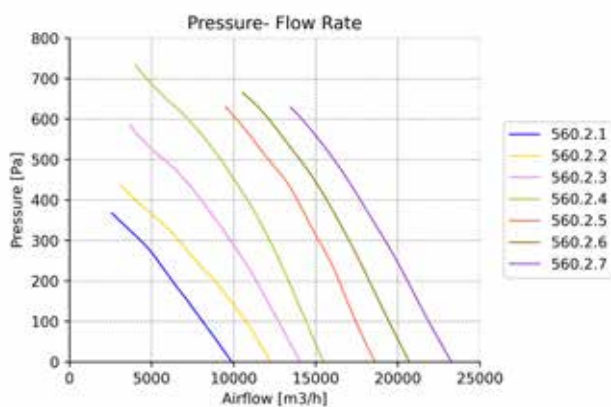

Ø560 / 6 Blade

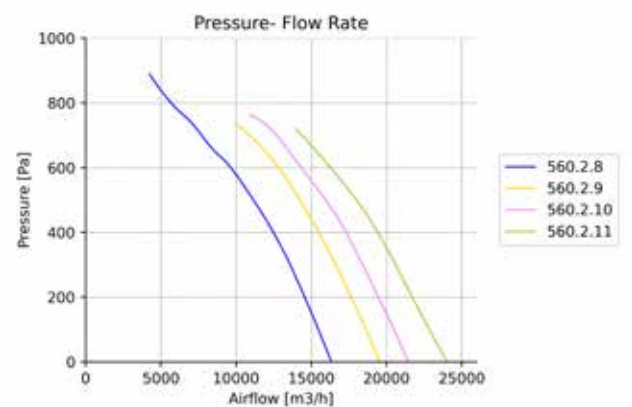

DRAGONFLY R - SYSTEM CURVE - 2 POLES

Ø560 / 10 Blade

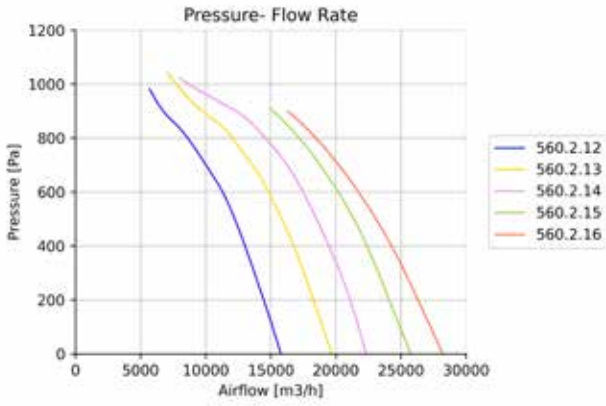

Ø630 / 3-4-5-6 Blade

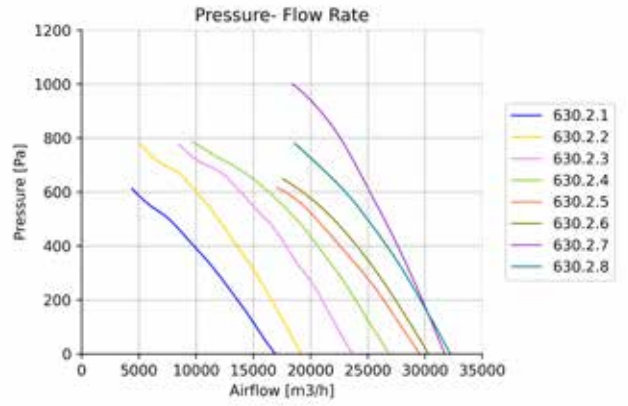

Ø630 / 6-10-12 Blade

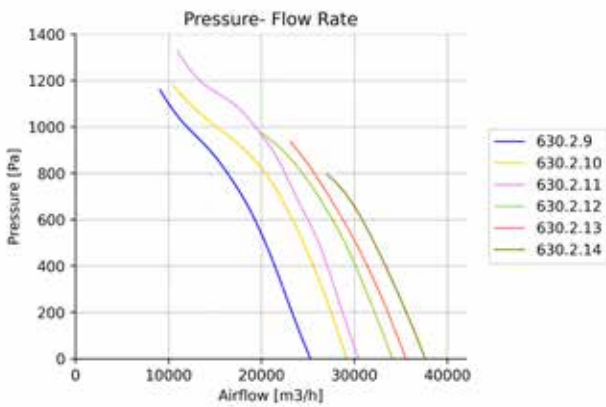

Ø710 / 3-6 Blade

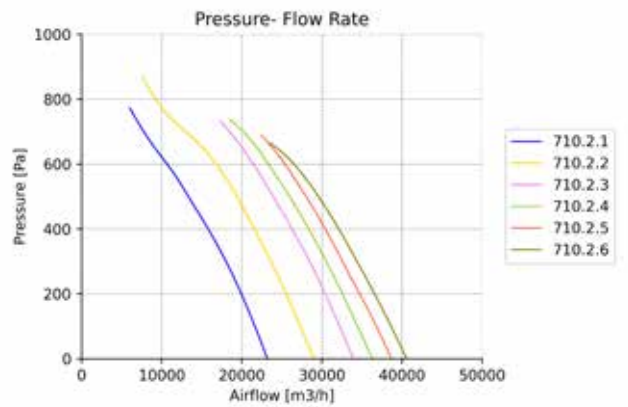

Ø710 / 6-12 Blade

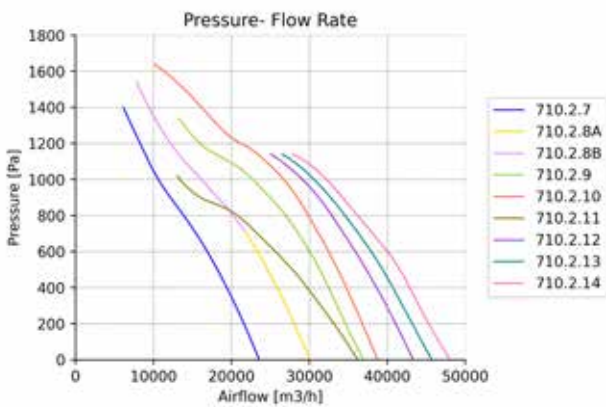

Ø800 / 3-6 Blade

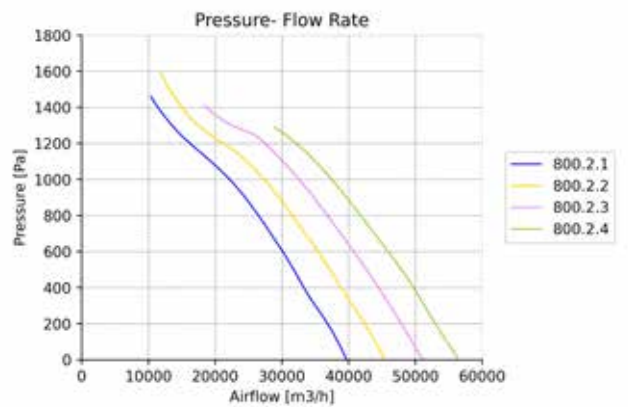

DRAGONFLY R - SYSTEM CURVE - 2 POLES

Ø800 / 6-6 Blade

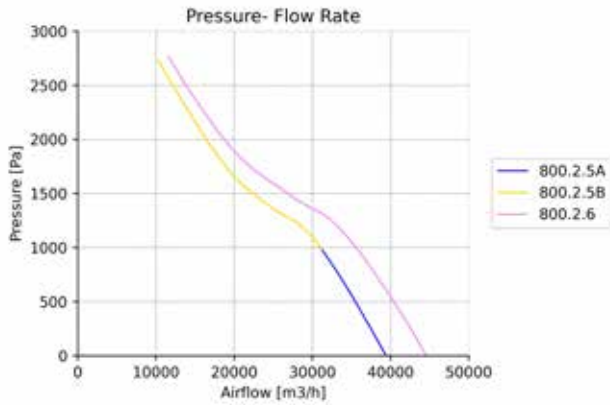

DRAGONFLY R - SYSTEM CURVE - 4 POLES

Ø400 / 6-8 Blade

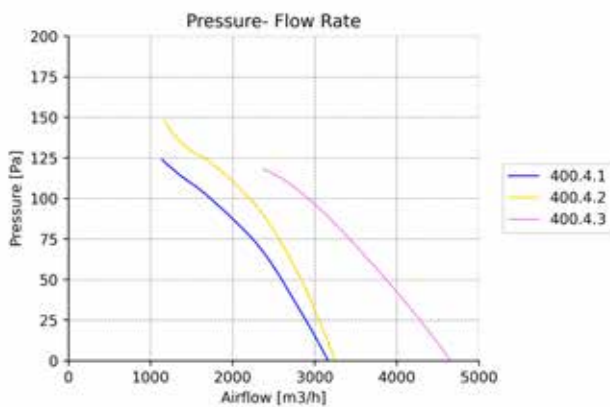

Ø450 / 6-8-10 Blade

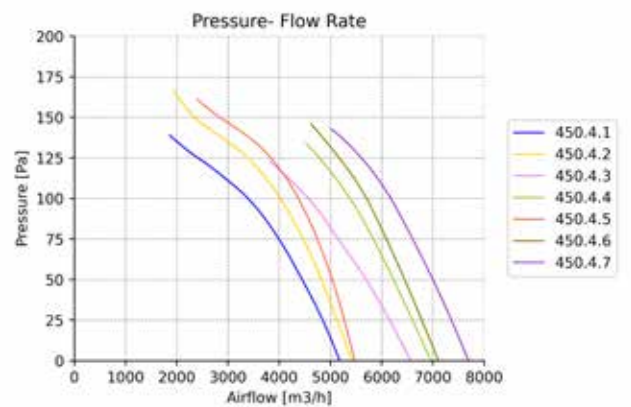

Ø500 / 6-8-10-12 Blade

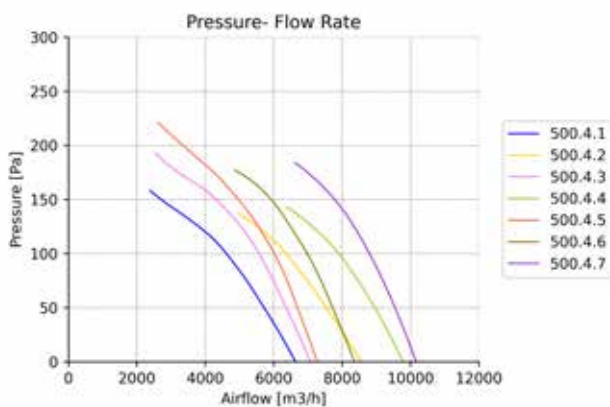

Ø560 / 3-4-6-8 Blade

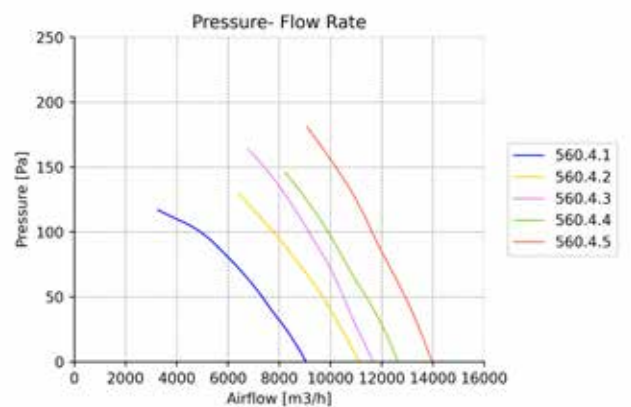

DRAGONFLY R - SYSTEM CURVE - 4 POLES

Ø560 / 10-12 Blade

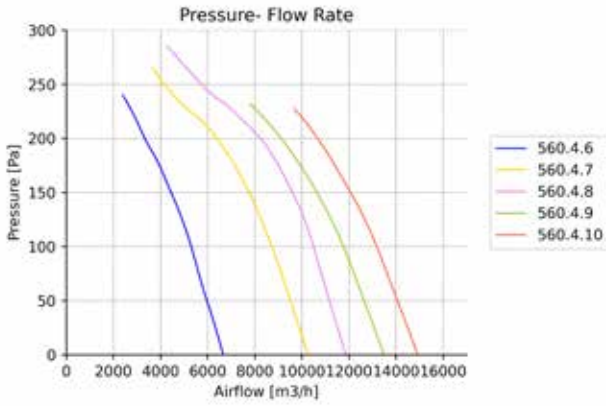

Ø630 / 5-6-8 Blade

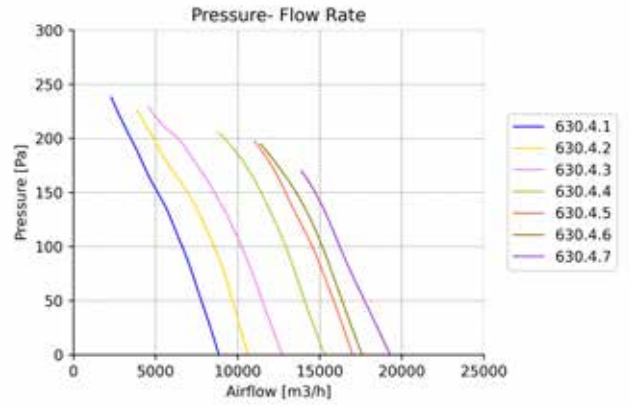

Ø630 / 10-12 Blade

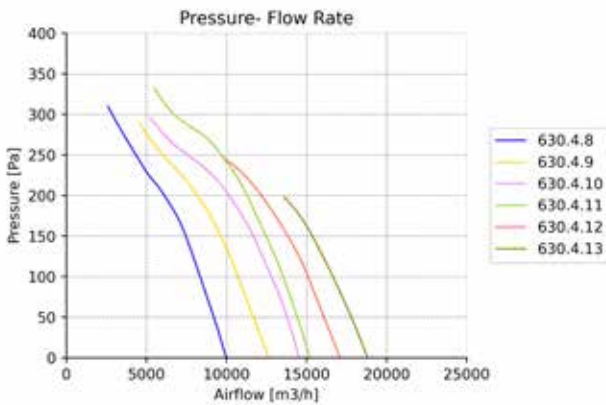

Ø630 / 9-12 Blade

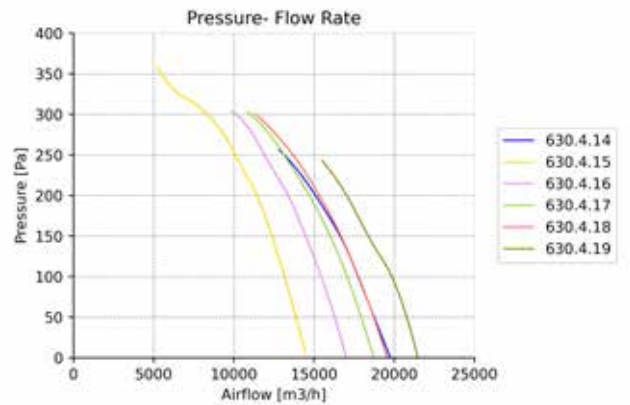

Ø710 / 5-6 Blade

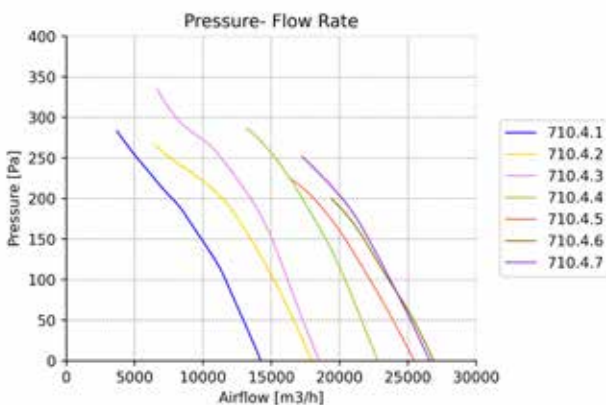

Ø710 / 9-12 Blade

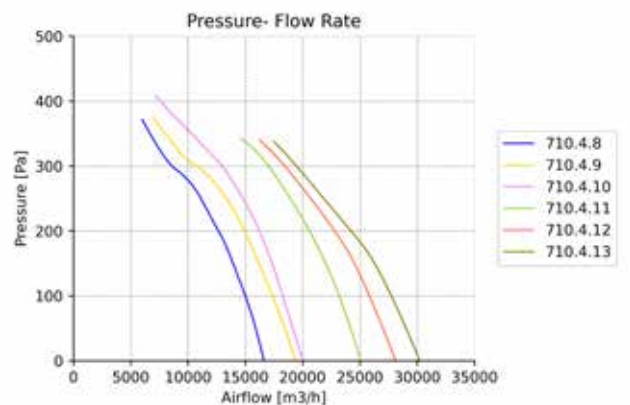

DRAGONFLY R - SYSTEM CURVE - 4 POLES

Ø800 / 6 Blade

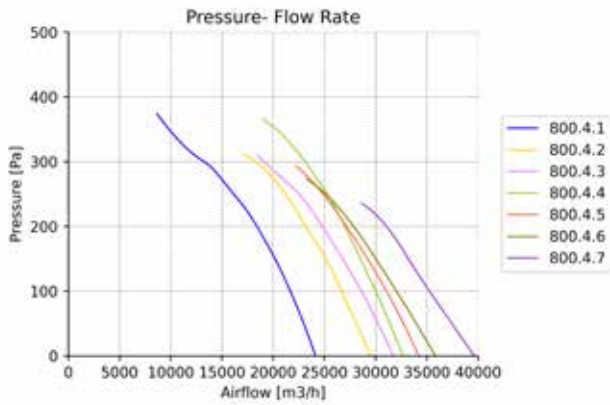

Ø800 / 8 Blade

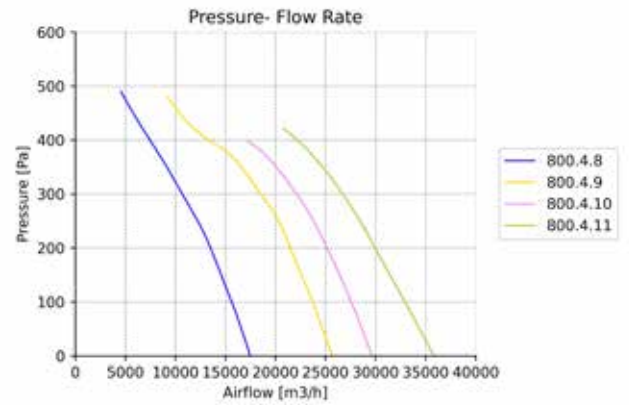

Ø800 / 9-12 Blade

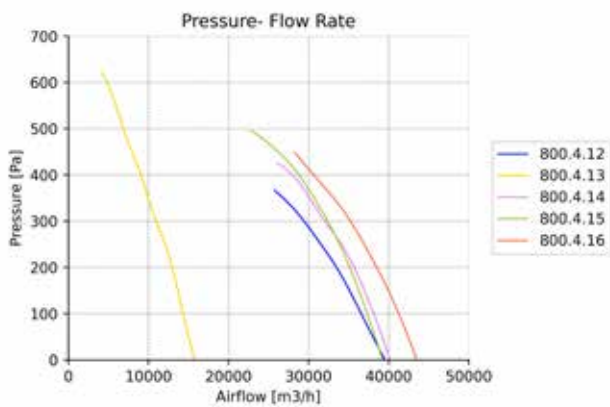

Ø800 / 6 Blade

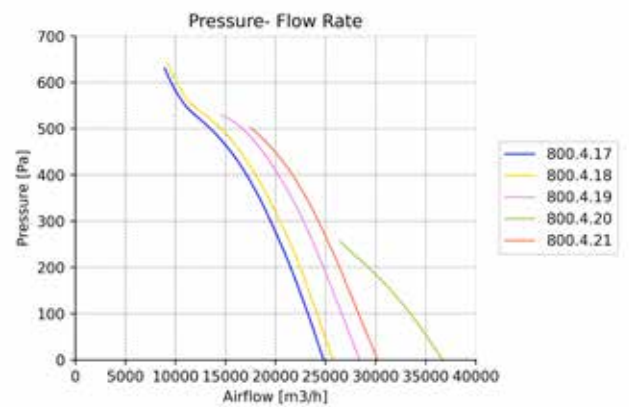

Ø900 / 6 Blade

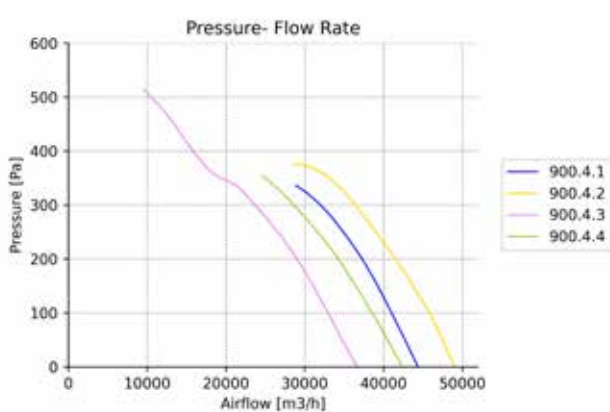

Ø900 / 8 Blade

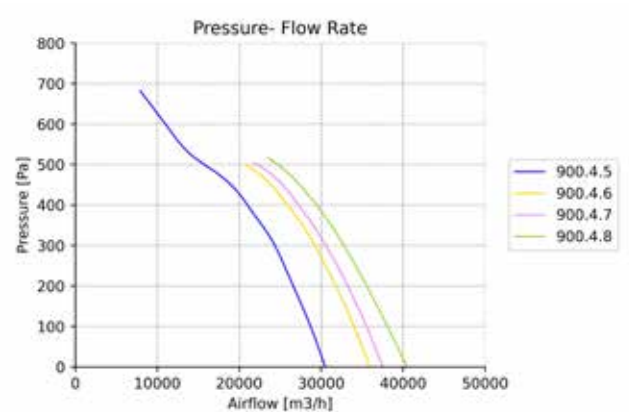

DRAGONFLY R - SYSTEM CURVE - 4 POLES

Ø900 / 9 Blade

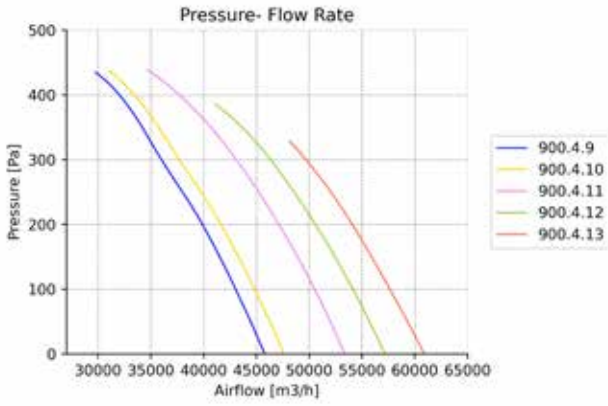

Ø900 / 12 Blade

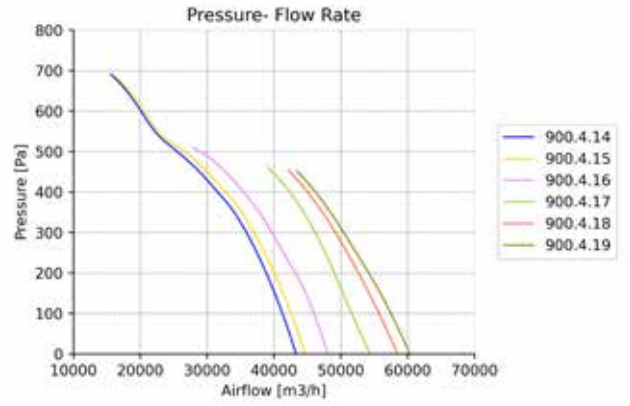

Ø900 / 6 Blade

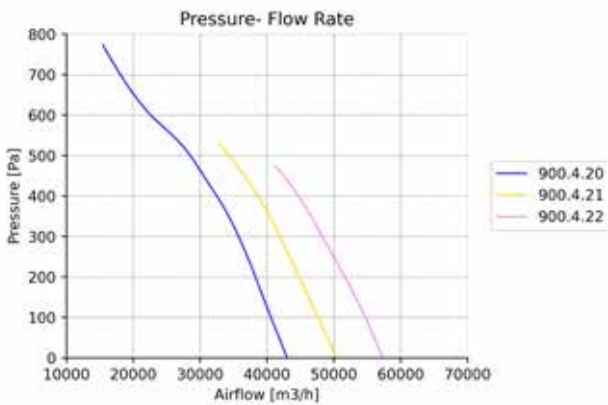

Ø1000 / 3 Blade

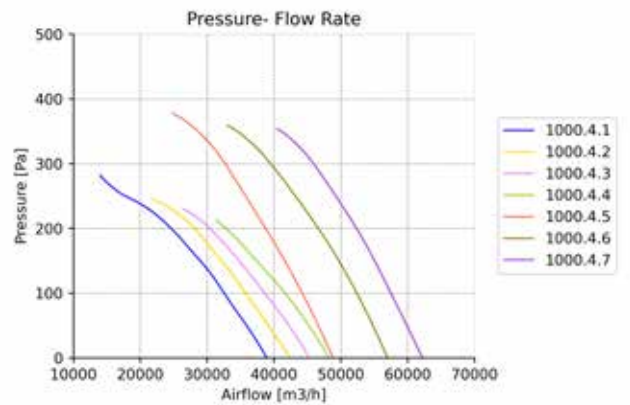

Ø1000 / 5-6 Blade

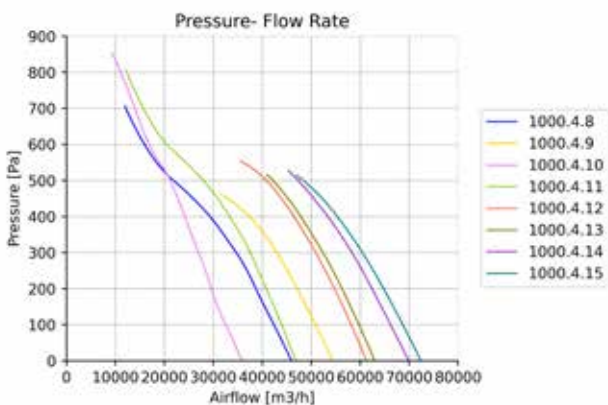

Ø1000 / 6 Blade

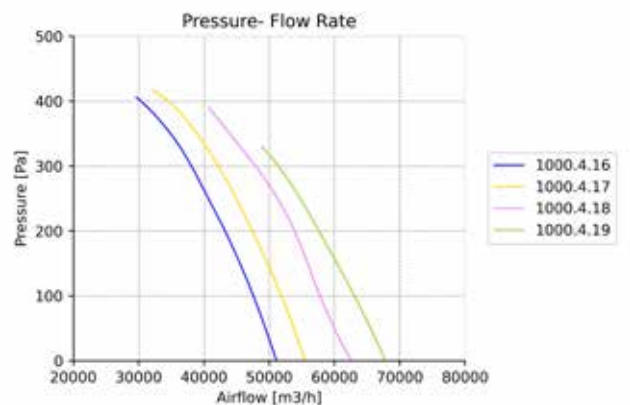

DRAGONFLY R - SYSTEM CURVE - 4 POLES

Ø1000 / 6 Blade

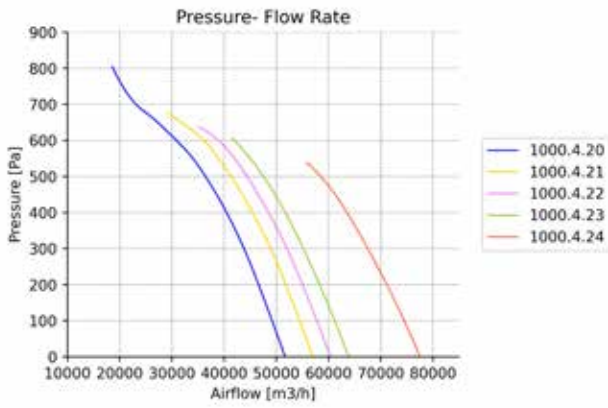

Ø1000 / 8 Blade

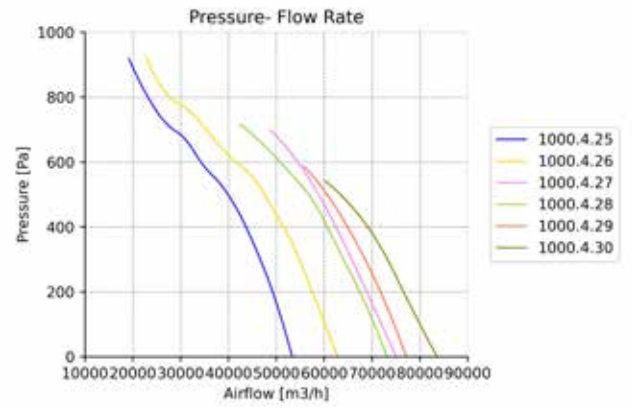

Ø1000 / 9 Blade

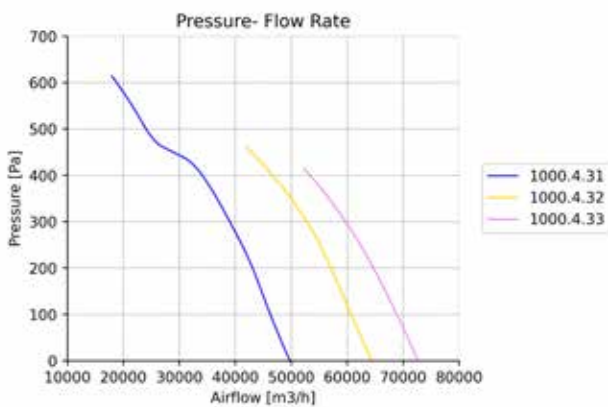

Ø1000 / 10 Blade

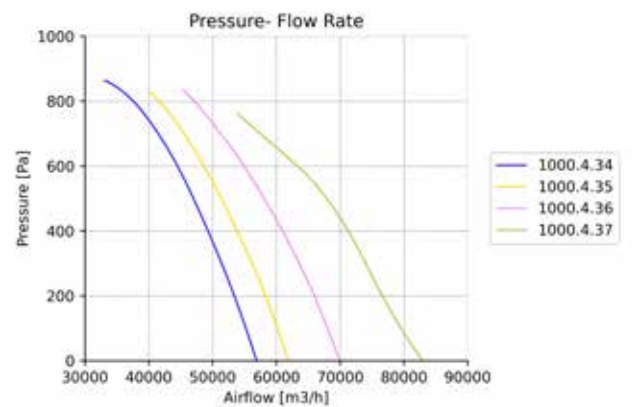

Ø1120 / 3 Blade

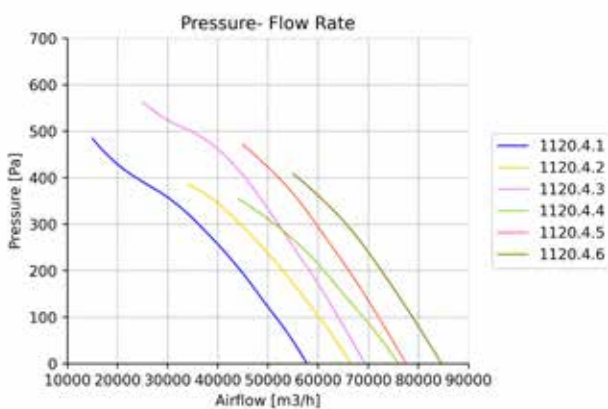

Ø1120 / 6 Blade

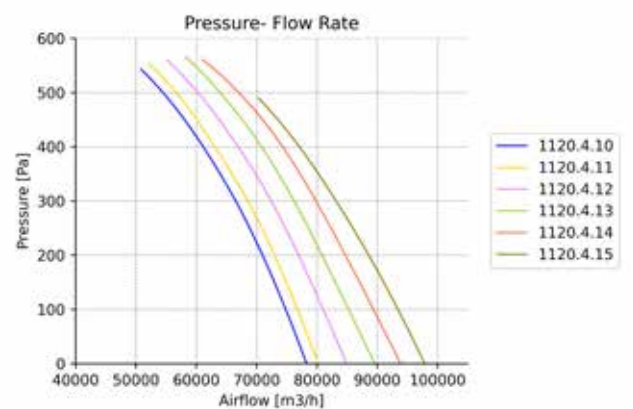

DRAGONFLY R - SYSTEM CURVE - 4 POLES

Ø1120 / 6 Blade

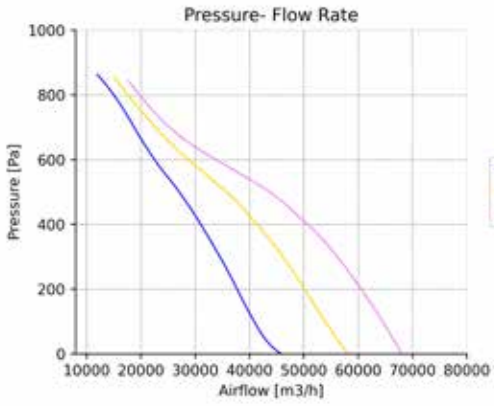

Ø1120 / 6 Blade

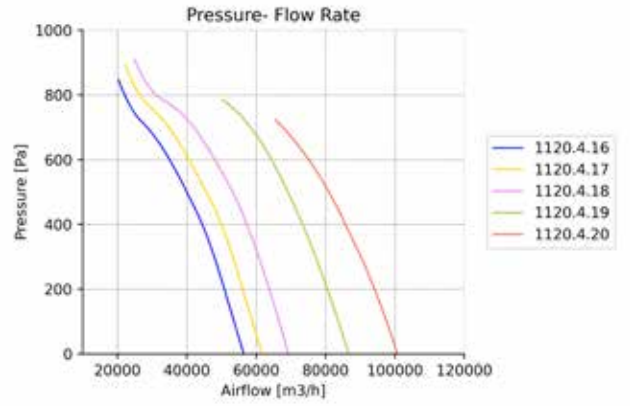

Ø1120 / 8 Blade

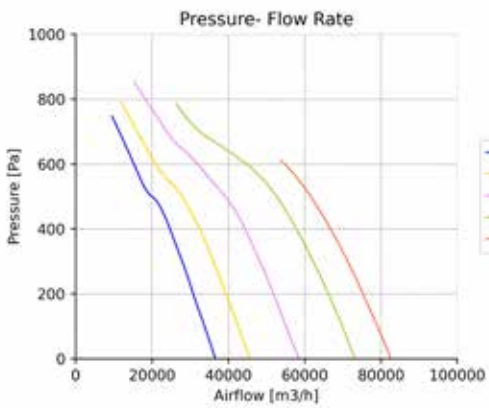

Ø1120 / 8 Blade

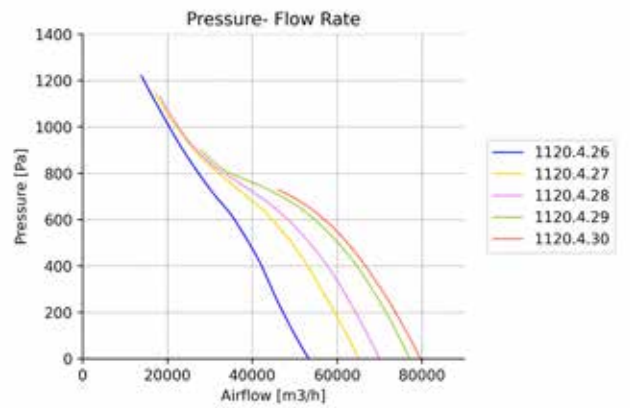

Ø1120 / 8 Blade

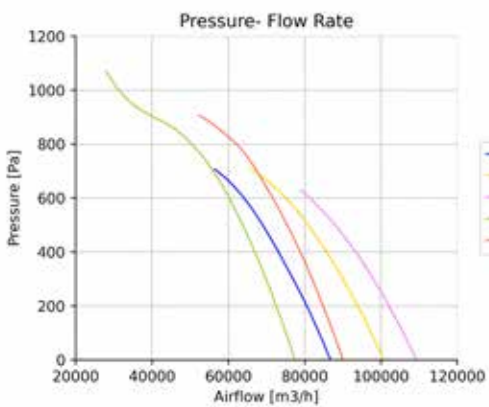

Ø1120 / 10-12 Blade

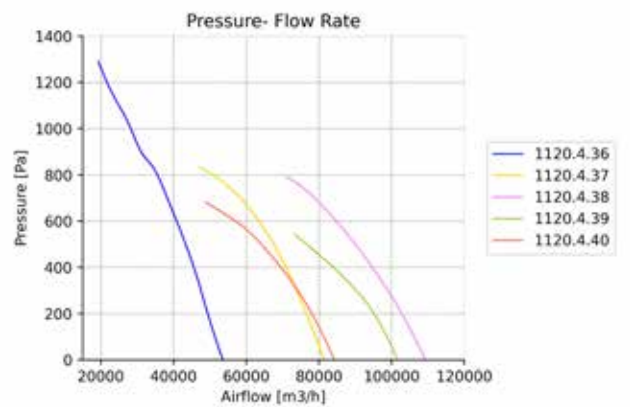

DRAGONFLY R - SYSTEM CURVE - 4 POLES

Ø1250 / 3 Blade

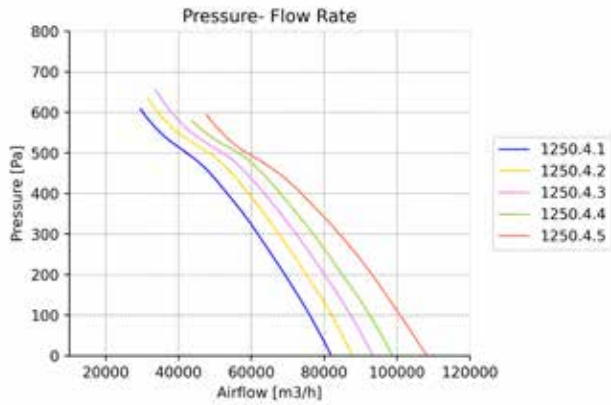

Ø1250 / 6 Blade

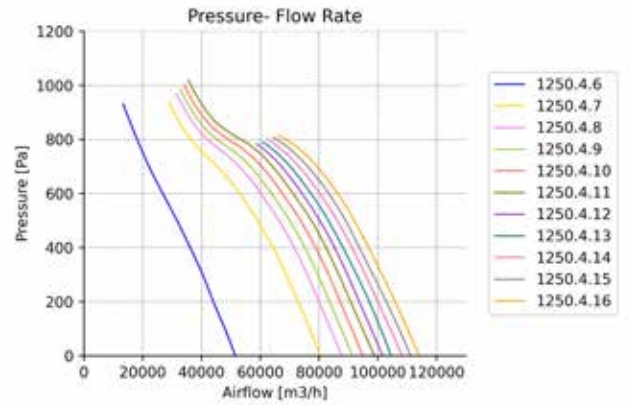

Ø1250 / 6 Blade

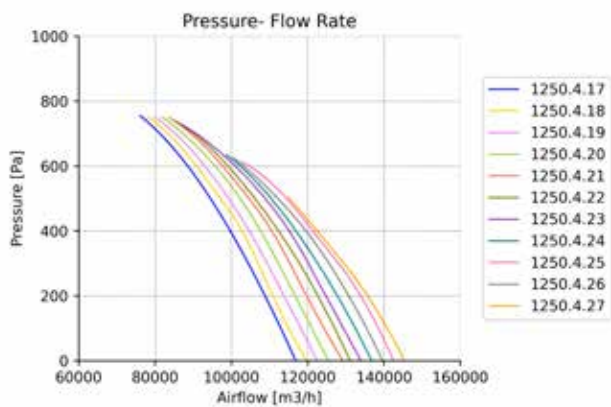

Ø1250 / 8 Blade

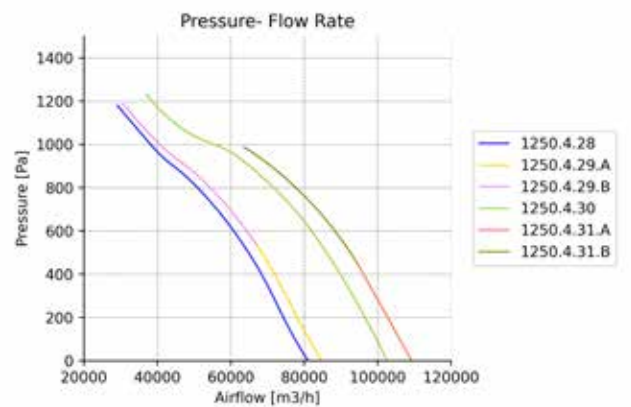

Ø1250 / 8 Blade

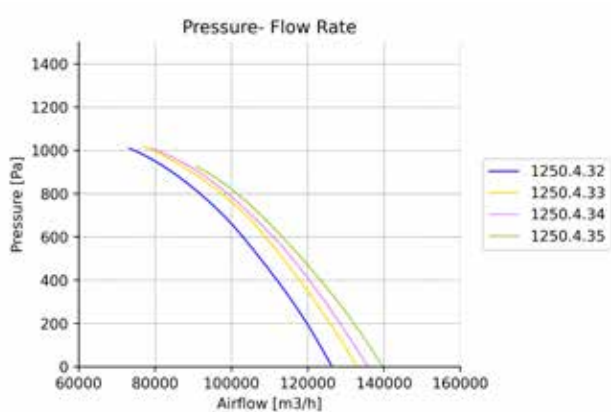

Ø1250 / 5 Blade

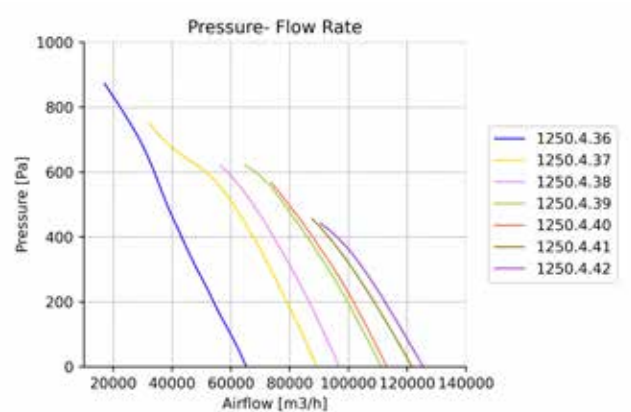

PRODUCT DIMENSIONS

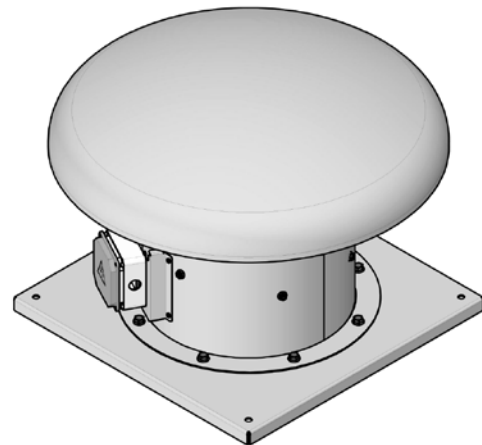
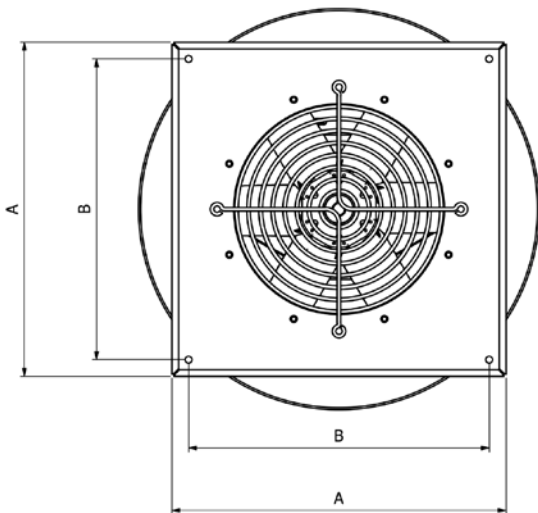
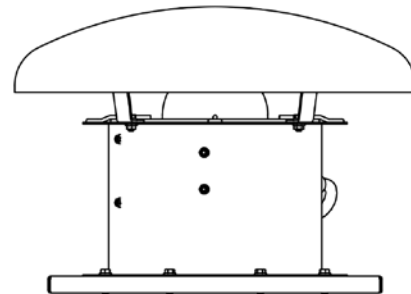
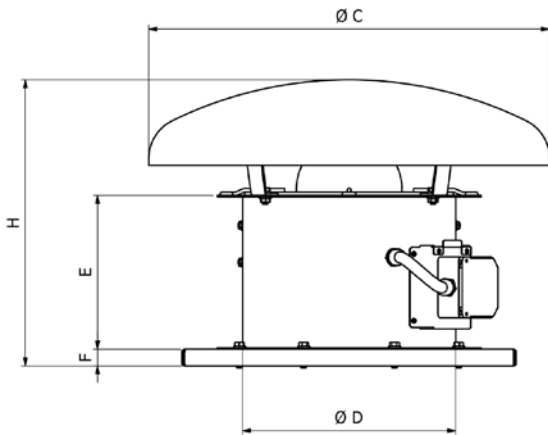

MODEL	MOTOR FRAME SIZE	A	B	C	ØD	E	F	H
DF-R 400	63/71/80/90	650	600	600	400	230	25	430
DF-R 450	63/71/80/90/110/112	650	600	900	450	250	30	550
DF-R 500	63/71/80/90/110/112	750	700	900	500	250	30	550
DF-R 560	71/80/90/110/112/132	750	700	900	560	300	30	550
DF-R 630	71/80/90/110/112/132	1000	940	1200	630	350	40	660
DF-R 630	160	1000	940	1200	630	550	40	860
DF-R 710	80/90/110/112/132	1000	940	1200	710	350	40	660
DF-R 710	160	1000	940	1200	710	550	40	860
DF-R 800	80/90/110/112/132	1100	1000	1500	800	350	50	810
DF-R 800	160	1100	1000	1500	800	550	50	1010
DF-R 900	80/90/110/112/132	1300	1200	1500	900	350	50	810
DF-R 900	160/180	1300	1200	1500	900	550	50	1010
DF-R 1000	80/90/110/112/132	1300	1200	1500	1000	350	50	810
DF-R 1000	160/180/200/225	1300	1200	1500	1000	550	50	1010

TECHNICAL PARAMETERS

MODEL	MODEL NUMBER	Voltage Frequency	Motor Power	Current	Rotation Speed	Sound Pressure	Protection Class	Working Range	Mass
		V-Hz	kW	A	RPM	Lp(A) dB at 3m	IP	°C	~ Kg
DF400F3-RAA1U-2T0,75	400.2.1	400-50	0,75	1,5	2880	70,5	55	300	42
DF400F3-RAA2U-2T0,75	400.2.2	400-50	0,75	1,6	2880	68,5	55	300	42
DF400F3-RAA3U-2T0,75	400.2.3	400-50	0,75	1,7	2880	69,8	55	300	42
DF400F3-RAA4U-2T0,75	400.2.4	400-50	0,75	1,7	2880	70,6	55	300	42
DF400F3-RAA5U-2T1,1	400.2.5	400-50	1,1	2,3	2880	73,2	55	300	47
DF400F3-RAA6U-2T1,1	400.2.6	400-50	1,1	2,3	2880	70,5	55	300	47
DF400F3-RAA7U-2T1,5	400.2.7	400-50	1,5	3,3	2880	73	55	300	51
DF400F3-RAA8U-2T2,2	400.2.8	400-50	2,2	4,5	2880	75,4	55	300	54
DF400F3-RAA9U-2T0,75	400.2.9	400-50	0,75	1,7	2880	73,6	55	300	42
DF400F3-RAA10U-2T0,75	400.2.10	400-50	0,75	1,7	2880	71,6	55	300	42
DF400F3-RAA11U-2T1,1	400.2.11	400-50	1,1	2,3	2880	70,2	55	300	47
DF400F3-RAA12U-2T1,5	400.2.12	400-50	1,5	3,3	2880	71,4	55	300	52
DF400F3-RAA13U-2T1,5	400.2.13	400-50	1,5	3,3	2880	71,2	55	300	52
DF400F3-RAA14U-2T2,2	400.2.14	400-50	2,2	4,5	2880	71,5	55	300	54
DF400F3-RAA15U-2T3	400.2.15	400-50	3	5,9	2880	74,3	55	300	64
DF450F3-RAA1U-2T0,75	450.2.1	400-50	0,75	1,6	2880	74	55	300	49
DF450F3-RAA2U-2T0,75	450.2.2	400-50	0,75	1,7	2880	77,9	55	300	49
DF450F3-RAA3U-2T1,1	450.2.3	400-50	1,1	2,3	2880	72,9	55	300	57
DF450F3-RAA4U-2T1,1	450.2.4	400-50	1,1	2,3	2880	74,3	55	300	57
DF450F3-RAA5U-2T1,1	450.2.5	400-50	1,1	2,3	2880	78	55	300	57
DF450F3-RAA6U-2T1,5	450.2.6	400-50	1,5	3,3	2880	72,3	55	300	61
DF450F3-RAA7U-2T2,2	450.2.7	400-50	2,2	4,5	2880	75,4	55	300	61
DF450F3-RAA8U-2T1,5	450.2.8	400-50	1,5	3,3	2880	77,3	55	300	62
DF450F3-RAA9U-2T2,2	450.2.9	400-50	2,2	4,5	2880	75,6	55	300	62
DF450F3-RAA10U-2T2,2	450.2.10	400-50	2,2	4,5	2880	74,9	55	300	62
DF450F3-RAA11U-2T3	450.2.11	400-50	3	5,9	2880	76	55	300	71
DF450F3-RAA12U-2T4	450.2.12	400-50	4	7,9	2880	79,2	55	300	77
DF450F3-RAA13U-2T3	450.2.13	400-50	3	5,9	2880	74,4	55	300	71
DF450F3-RAA14U-2T3	450.2.14	400-50	3	5,9	2880	74,4	55	300	71
DF450F3-RAA15U-2T5,5	450.2.15	400-50	5,5	10,3	2880	75,7	55	300	93
DF500F3-RAA1U-2T0,75	500.2.1	400-50	0,75	1,7	2880	81,3	55	300	44
DF500F3-RAA2U-2T1,1	500.2.2	400-50	1,1	2,3	2880	75,8	55	300	50
DF500F3-RAA3U-2T1,5	500.2.3	400-50	1,5	3,3	2880	77,2	55	300	55
DF500F3-RAA4U-2T2,2	500.2.4	400-50	2,2	4,5	2880	75,4	55	300	57
DF500F3-RAA5U-2T2,2	500.2.6	400-50	2,2	4,5	2880	74,9	55	300	57
DF500F3-RAA6U-2T2,2	500.2.5	400-50	2,2	4,5	2880	71,8	55	300	57
DF500F3-RAA7U-2T3	500.2.7	400-50	3	5,9	2880	75,4	55	300	66
DF500F3-RAA8U-2T3	500.2.8	400-50	3	5,9	2880	79	55	300	66
DF500F3-RAA9U-2T4	500.2.9	400-50	4	7,9	2880	79,5	55	300	72
DF500F3-RAA10U-2T4	500.2.10	400-50	4	7,9	2880	77,2	55	300	73
DF500F3-RAA11U-2T5,5	500.2.11	400-50	5,5	10,3	2880	76,9	55	300	89
DF500F3-RAA12U-2T7,5	500.2.12	400-50	7,5	13,6	2880	77,7	55	300	94
DF500F3-RAA13U-2T7,5	500.2.13	400-50	7,5	13,6	2880	77,7	55	300	94
DF560F3-RAA1U-2T0,75	560.2.1	400-50	0,75	1,7	2880	77,7	55	300	68
DF560F3-RAA2U-2T1,1	560.2.2	400-50	1,1	2,3	2880	75,4	55	300	70

SMOKE AND HEAT EXTRACT FAN

MODEL	MODEL NUMBER	Voltage Frequency	Motor Power	Current	Rotation Speed	Sound Pressure	Protection Class	Working Range	Mass
		V-Hz	kW	A	RPM	Lp(A) dB at 3m	IP	°C	~ Kg
DF560F3-RAA3U-2T1,5	560.2.3	400-50	1,5	3,3	2880	78,7	55	300	74
DF560F3-RAA4U-2T2,2	560.2.4	400-50	2,2	5,9	2880	79	55	300	77
DF560F3-RAA5U-2T4	560.2.5	400-50	4	7,9	2880	77,7	55	300	93
DF560F3-RAA6U-2T4	560.2.6	400-50	4	7,9	2880	78,8	55	300	93
DF560F3-RAA7U-2T5,5	560.2.7	400-50	5,5	10,3	2880	80,6	55	300	109
DF560F3-RAA8U-2T3	560.2.8	400-50	3	5,9	2880	77,7	55	300	86
DF560F3-RAA9U-2T4	560.2.9	400-50	4	7,9	2880	78,2	55	300	94
DF560F3-RAA10U-2T5,5	560.2.10	400-50	5,5	10,3	2880	78,5	55	300	109
DF560F3-RAA11U-2T7,5	560.2.11	400-50	7,5	13,6	2880	80,3	55	300	114
DF560F3-RAA12U-2T4	560.2.12	400-50	4	7,9	2880	79,3	55	300	94
DF560F3-RAA13U-2T5,5	560.2.13	400-50	5,5	10,3	2880	80,7	55	300	110
DF560F3-RAA14U-2T7,5	560.2.14	400-50	7,5	13,6	2880	79,4	55	300	115
DF560F3-RAA15U-2T11	560.2.15	400-50	11	19,5	2880	80,1	55	300	169
DF560F3-RAA16U-2T11	560.2.16	400-50	11	19,5	2880	79,8	55	300	169
DF630F3-RAA1U-2T2,2	630.2.1	400-50	2,2	4,5	2880	78,7	55	300	91
DF630F3-RAA2U-2T3	630.2.2	400-50	3	5,9	2880	79,8	55	300	101
DF630F3-RAA3U-2T5,5	630.2.3	400-50	5,5	10,3	2880	78,2	55	300	125
DF630F3-RAA4U-2T5,5	630.2.4	400-50	5,5	10,3	2880	80,3	55	300	125
DF630F3-RAA5U-2T7,5	630.2.5	400-50	7,5	13,6	2880	83,5	55	300	130
DF630F3-RAA6U-2T7,5	630.2.6	400-50	7,5	13,6	2880	81,4	55	300	130
DF630F3-RAA7U-2T11	630.2.7	400-50	11	19,5	2880	83,7	55	300	187
DF630F3-RAA8U-2T11	630.2.8	400-50	11	19,5	2880	81,7	55	300	186
DF630F3-RAA9U-2T7,5	630.2.9	400-50	7,5	13,6	2880	83,4	55	300	131
DF630F3-RAA10U-2T11	630.2.10	400-50	11	19,5	2880	81,6	55	300	187
DF630F3-RAA11U-2T11	630.2.11	400-50	11	19,5	2880	81,7	55	300	187
DF630F3-RAA12U-2T15	630.2.12	400-50	15	28,3	2880	81,6	55	300	195
DF630F3-RAA13U-2T15	630.2.13	400-50	15	28,3	2880	83,7	55	300	195
DF630F3-RAA14U-2T15	630.2.14	400-50	15	28,3	2880	81,5	55	300	195
DF710F3-RAA1U-2T3	710.2.1	400-50	3	5,9	2880	84,8	55	300	105
DF710F3-RAA2U-2T5,5	710.2.2	400-50	5,5	10,3	2880	82	55	300	130
DF710F3-RAA3U-2T7,5	710.2.3	400-50	7,5	13,6	2880	82,3	55	300	135
DF710F3-RAA4U-2T7,5	710.2.4	400-50	7,5	13,6	2880	83,1	55	300	135
DF710F3-RAA5U-2T11	710.2.5	400-50	11	19,5	2880	83,9	55	300	185
DF710F3-RAA6U-2T11	710.2.6	400-50	11	19,5	2880	84,9	55	300	185
DF710F3-RAA7U-2T5,5	710.2.7	400-50	5,5	10,3	2880	92,5	55	300	125
DF710F3-RAA8.AU-2T7,5	710.2.8A	400-50	7,5	13,6	2880	88,5	55	300	136
DF710F3-RAA8.BU-2T11	710.2.8B	400-50	11	19,5	2880	88,5	55	300	186
DF710F3-RAA9U-2T15	710.2.9	400-50	15	28,3	2880	81,4	55	300	201
DF710F3-RAA10U-2T11	710.2.10	400-50	11	19,5	2880	86,5	55	300	186
DF710F3-RAA11U-2T15	710.2.11	400-50	15	28,3	2880	83,3	55	300	203
DF710F3-RAA12U-2T15	710.2.12	400-50	15	28,3	2880	86,5	55	300	199
DF710F3-RAA13U-2T18,5	710.2.13	400-50	18,5	32,3	2880	87,5	55	300	221
DF710F3-RAA14U-2T18,5	710.2.14	400-50	18,5	32,3	2880	87,5	55	300	221
DF800F3-RAA1U-2T11	800.2.1	400-50	11	19,5	2880	87,5	55	300	197
DF800F3-RAA2U-2T15	800.2.2	400-50	15	28,3	2880	88,5	55	300	205
DF800F3-RAA3U-2T18,5	800.2.3	400-50	18,5	32,3	2880	90,5	55	300	227

MODEL	MODEL NUMBER	Voltage Frequency	Motor Power	Current	Rotation Speed	Sound Pressure	Protection Class	Working Range	Mass
		V-Hz	kW	A	RPM	Lp(A) dB at 3m	IP	°C	~ Kg
DF800F3-RAA4U-2T22	800.2.4	400-50	22	38,3	2880	91,5	55	300	267
DF800F3-RAA5U-2T18,5	800.2.5	400-50	18,5	32,3	2880	91,5	55	300	227
DF800F3-RAA6U-2T18,5	800.2.6	400-50	18,5	32,3	2880	91,5	55	300	227
DF800F3-RAA7U-2T22	800.2.7	400-50	22	38,3	2880	91,5	55	300	262
DF400F3-RAA1U-4T0,75	400.4.1	400-50	0,75	1,13	1440	56,5	55	300	44
DF400F3-RAA2U-4T0,75	400.4.2	400-50	0,75	1,13	1440	56,7	55	300	44
DF400F3-RAA3U-4T0,75	400.4.3	400-50	0,75	1,13	1440	57,6	55	300	44
DF450F3-RAA1U-4T0,75	450.4.1	400-50	0,75	1,13	1440	58,7	55	300	51
DF450F3-RAA2U-4T0,75	450.4.2	400-50	0,75	1,13	1440	60,6	55	300	51
DF450F3-RAA3U-4T0,75	450.4.3	400-50	0,75	1,13	1440	60,7	55	300	51
DF450F3-RAA4U-4T0,75	450.4.4	400-50	0,75	1,55	1440	59,4	55	300	51
DF450F3-RAA5U-4T0,75	450.4.5	400-50	0,75	1,13	1440	59,4	55	300	52
DF450F3-RAA6U-4T0,75	450.4.6	400-50	0,75	1,55	1440	59,4	55	300	52
DF450F3-RAA7U-4T0,75	450.4.7	400-50	0,75	2	1440	59,5	55	300	52
DF500F3-RAA1U-4T0,75	500.4.1	400-50	0,75	1,13	1440	57,7	55	300	48
DF500F3-RAA2U-4T0,75	500.4.2	400-50	0,75	1,55	1440	62,5	55	300	48
DF500F3-RAA3U-4T0,75	500.4.3	400-50	0,75	1,13	1440	63,6	55	300	47
DF500F3-RAA4U-4T0,75	500.4.4	400-50	0,75	2	1440	62,8	55	300	47
DF500F3-RAA5U-4T0,75	500.4.5	400-50	0,75	1,55	1440	63,8	55	300	48
DF500F3-RAA6U-4T0,75	500.4.6	400-50	0,75	2	1440	63,8	55	300	48
DF500F3-RAA7U-4T1,1	500.4.7	400-50	1,1	2,6	1440	64,5	55	300	57
DF560F3-RAA1U-4T0,75	560.4.1	400-50	0,75	1,13	1440	64,6	55	300	70
DF560F3-RAA2U-4T0,75	560.4.2	400-50	0,75	1,55	1440	64,2	55	300	70
DF560F3-RAA3U-4T0,75	560.4.3	400-50	0,75	2	1440	65,5	55	300	70
DF560F3-RAA4U-4T0,75	560.4.4	400-50	0,75	2	1440	66	55	300	70
DF560F3-RAA5U-4T1,1	560.4.5	400-50	1,1	2,6	1440	65,7	55	300	78
DF560F3-RAA6U-4T0,75	560.4.6	400-50	0,75	1,13	1440	66,3	55	300	71
DF560F3-RAA7U-4T0,75	560.4.7	400-50	0,75	2	1440	65,8	55	300	71
DF560F3-RAA8U-4T1,1	560.4.8	400-50	1,1	2,6	1440	64,8	55	300	80
DF560F3-RAA9U-4T1,1	560.4.9	400-50	1,1	2,6	1440	65,3	55	300	79
DF560F3-RAA10U-4T1,5	560.4.10	400-50	1,5	3,5	1440	66,2	55	300	83
DF630F3-RAA1U-4T0,75	630.4.1	400-50	0,75	1,55	1440	66,4	55	300	86
DF630F3-RAA2U-4T0,75	630.4.2	400-50	0,75	1,55	1440	66	55	300	86
DF630F3-RAA3U-4T0,75	630.4.3	400-50	0,75	2	1440	64,2	55	300	86
DF630F3-RAA4U-4T1,1	630.4.4	400-50	1,1	2,6	1440	67,6	55	300	91
DF630F3-RAA5U-4T1,5	630.4.5	400-50	1,5	3,5	1440	68,4	55	300	94
DF630F3-RAA6U-4T1,5	630.4.6	400-50	1,5	2	1440	67,2	55	300	94
DF630F3-RAA7U-4T2,2	630.4.7	400-50	2,2	5	1440	71,1	55	300	102
DF630F3-RAA8U-4T0,75	630.4.8	400-50	0,75	2	1440	67,8	55	300	86
DF630F3-RAA9U-4T0,75	630.4.9	400-50	0,75	2	1440	73	55	300	86
DF630F3-RAA10U-4T1,1	630.4.10	400-50	1,1	2,6	1440	66,5	55	300	91
DF630F3-RAA11U-4T1,5	630.4.11	400-50	1,5	3,5	1440	66,4	55	300	95
DF630F3-RAA12U-4T1,5	630.4.12	400-50	1,5	3,5	1440	67	55	300	95
DF630F3-RAA13U-4T2,2	630.4.13	400-50	2,2	5	1440	68	55	300	102
DF630F3-RAA14U-4T2,2	630.4.14	400-50	2,2	5	1440	68,1	55	300	103
DF630F3-RAA15U-4T1,5	630.4.15	400-50	1,5	3,5	1440	71,3	55	300	97

SMOKE AND HEAT EXTRACT FAN

MODEL	MODEL NUMBER	Voltage Frequency	Motor Power	Current	Rotation Speed	Sound Pressure	Protection Class	Working Range	Mass
		V-Hz	kW	A	RPM	Lp(A) dB at 3m	IP	°C	~ Kg
DF630F3-RAA16U-4T2,2	630.4.16	400-50	2,2	5	1440	71,2	55	300	104
DF630F3-RAA17U-4T2,2	630.4.17	400-50	2,2	5	1440	71,1	55	300	104
DF630F3-RAA18U-4T2,2	630.4.18	400-50	2,2	5	1440	71,4	55	300	104
DF630F3-RAA19U-4T3	630.4.19	400-50	3	6,6	1440	72,8	55	300	111
DF710F3-RAA1U-4T0,75	710.4.1	400-50	0,75	2	1440	71,8	55	300	89
DF710F3-RAA2U-4T1,5	710.4.2	400-50	1,5	3,5	1440	69	55	300	98
DF710F3-RAA3U-4T1,5	710.4.3	400-50	1,5	3,5	1440	71,9	55	300	98
DF710F3-RAA4U-4T2,2	710.4.4	400-50	2,2	5	1440	72	55	300	106
DF710F3-RAA5U-4T3	710.4.5	400-50	3	6,6	1440	72,8	55	300	112
DF710F3-RAA6U-4T3	710.4.6	400-50	3	6,6	1440	73,5	55	300	112
DF710F3-RAA7U-4T3	710.4.7	400-50	3	6,6	1440	74,1	55	300	112
DF710F3-RAA8U-4T1,5	710.4.8	400-50	1,5	3,5	1440	69,8	55	300	102
DF710F3-RAA9U-4T2,2	710.4.9	400-50	2,2	5	1440	68,2	55	300	110
DF710F3-RAA10U-4T2,2	710.4.10	400-50	2,2	5	1440	73,8	55	300	108
DF710F3-RAA11U-4T3	710.4.11	400-50	3	6,6	1440	73	55	300	115
DF710F3-RAA12U-4T4	710.4.12	400-50	4	8,4	1440	73,5	55	300	131
DF710F3-RAA13U-4T4	710.4.13	400-50	4	8,4	1440	72,5	55	300	128
DF710F3-RAA14U-4T5,5	710.4.14	400-50	5,5	11,2	1440	73,5	55	300	137
DF800F3-RAA1U-4T2,2	800.4.1	400-50	2,2	5	1440	76,8	55	300	118
DF800F3-RAA2U-4T3	800.4.2	400-50	3	6,6	1440	75	55	300	124
DF800F3-RAA3U-4T3	800.4.3	400-50	3	6,6	1440	74,1	55	300	123
DF800F3-RAA4U-4T4	800.4.4	400-50	4	8,4	1440	75,1	55	300	145
DF800F3-RAA5U-4T4	800.4.5	400-50	4	8,4	1440	75,3	55	300	146
DF800F3-RAA6U-4T4	800.4.6	400-50	4	8,4	1440	74,6	55	300	144
DF800F3-RAA7U-4T5,5	800.4.7	400-50	5,5	11,2	1440	76,1	55	300	155
DF800F3-RAA8U-4T5,5	800.4.8	400-50	5,5	11,2	1440	76,8	55	300	153
DF800F3-RAA9U-4T1,5	800.4.9	400-50	1,5	3,5	1440	79,2	55	300	110
DF800F3-RAA10U-4T3	800.4.10	400-50	3	6,6	1440	78,1	55	300	124
DF800F3-RAA11U-4T4	800.4.11	400-50	4	8,4	1440	76,7	55	300	146
DF800F3-RAA12U-4T5,5	800.4.12	400-50	5,5	11,2	1440	75,7	55	300	155
DF800F3-RAA13U-4T7,5	800.4.13	400-50	7,5	15,4	1440	76,7	55	300	166
DF800F3-RAA14U-4T2,2	800.4.14	400-50	2,2	5	1440	78,3	55	300	118
DF800F3-RAA15U-4T11	800.4.15	400-50	11	21,3	1440	77,1	55	300	248
DF800F3-RAA16U-4T7,5	800.4.16	400-50	7,5	15,4	1440	76,9	55	300	166
DF800F3-RAA17U-4T11	800.4.17	400-50	11	21,3	1440	77,4	55	300	248
DF800F3-RAA18U-4T4	800.4.18	400-50	4	8,4	1440	77,8	55	300	155
DF800F3-RAA19U-4T4	800.4.19	400-50	4	8,4	1440	78	55	300	155
DF800F3-RAA20U-4T5,5	800.4.20	400-50	5,5	11,2	1440	77,5	55	300	164
DF800F3-RAA21U-4T5,5	800.4.21	400-50	5,5	11,2	1440	76,9	55	300	164
DF900F3-RAA1U-4T5,5	900.4.1	400-50	5,5	11,2	1440	82,7	55	300	164
DF900F3-RAA2U-4T7,5	900.4.2	400-50	7,5	15,4	1440	76,5	55	300	175
DF900F3-RAA3U-4T4	900.4.3	400-50	4	8,4	1440	76,3	55	300	155
DF900F3-RAA4U-4T5,5	900.4.4	400-50	5,5	11,2	1440	76,4	55	300	164
DF900F3-RAA5U-4T4	900.4.5	400-50	4	8,4	1440	79,9	55	300	155
DF900F3-RAA6U-4T5,5	900.4.6	400-50	5,5	11,2	1440	79,1	55	300	164
DF900F3-RAA7U-4T7,5	900.4.7	400-50	7,5	15,4	1440	79,2	55	300	175

MODEL	MODEL NUMBER	Voltage Frequency	Motor Power	Current	Rotation Speed	Sound Pressure	Protection Class	Working Range	Mass
		V-Hz	kW	A	RPM	Lp(A) dB at 3m	IP	°C	~ Kg
DF900F3-RAA8U-4T7,5	900.4.8	400-50	7,5	15,4	1440	77,7	55	300	175
DF900F3-RAA9U-4T7,5	900.4.9	400-50	7,5	15,4	1440	78,5	55	300	175
DF900F3-RAA10U-4T7,5	900.4.10	400-50	7,5	15,4	1440	79,2	55	300	175
DF900F3-RAA11U-4T11	900.4.11	400-50	11	21,3	1440	78,8	55	300	246
DF900F3-RAA12U-4T11	900.4.12	400-50	11	21,3	1440	78,9	55	300	246
DF900F3-RAA13U-4T15	900.4.13	400-50	15	29,8	1440	78	55	300	257
DF900F3-RAA14U-4T7,5	900.4.14	400-50	7,5	15,4	1440	79,1	55	300	179
DF900F3-RAA15U-4T7,5	900.4.15	400-50	7,5	15,4	1440	81,9	55	300	179
DF900F3-RAA16U-4T11	900.4.16	400-50	11	21,3	1440	83,8	55	300	250
DF900F3-RAA17U-4T15	900.4.17	400-50	15	29,8	1440	79,7	55	300	262
DF900F3-RAA18U-4T15	900.4.18	400-50	15	29,8	1440	79,5	55	300	262
DF900F3-RAA19U-4T15	900.4.19	400-50	15	29,8	1440	80,3	55	300	262
DF900F3-RAA20U-4T11	900.4.20	400-50	11	21,3	1440	79,4	55	300	256
DF900F3-RAA21U-4T11	900.4.21	400-50	11	21,3	1440	79,4	55	300	256
DF900F3-RAA22U-4T15	900.4.22	400-50	15	29,8	1440	77,6	55	300	267
DF1000F3-RAA1U-4T3	1000.4.1	400-50	3	6,6	1440	76,1	55	300	173
DF1000F3-RAA2U-4T3	1000.4.2	400-50	3	6,6	1440	77	55	300	198
DF1000F3-RAA3U-4T4	1000.4.3	400-50	4	8,4	1440	77,7	55	300	209
DF1000F3-RAA4U-4T4	1000.4.4	400-50	4	8,4	1440	78,5	55	300	209
DF1000F3-RAA5U-4T5,5	1000.4.5	400-50	5,5	11,2	1440	78,4	55	300	226
DF1000F3-RAA6U-4T7,5	1000.4.6	400-50	7,5	15,4	1440	81,7	55	300	237
DF1000F3-RAA7U-4T11	1000.4.7	400-50	11	21,3	1440	83,4	55	300	326
DF1000F3-RAA8U-4T5,5	1000.4.8	400-50	5,5	11,2	1440	77,8	55	300	228
DF1000F3-RAA9U-4T7,5	1000.4.9	400-50	7,5	15,4	1440	79,3	55	300	239
DF1000F3-RAA10U-4T5,5	1000.4.10	400-50	5,5	11,2	1440	80,9	55	300	230
DF1000F3-RAA11U-4T7,5	1000.4.11	400-50	7,5	15,4	1440	84	55	300	241
DF1000F3-RAA12U-4T11	1000.4.12	400-50	11	21,3	1440	82	55	300	302
DF1000F3-RAA13U-4T11	1000.4.13	400-50	11	21,3	1440	82,4	55	300	302
DF1000F3-RAA14U-4T15	1000.4.14	400-50	15	29,8	1440	83,8	55	300	313
DF1000F3-RAA15U-4T15	1000.4.15	400-50	15	29,8	1440	84,4	55	300	313
DF1000F3-RAA16U-4T7,5	1000.4.16	400-50	7,5	15,4	1440	81,7	55	300	232
DF1000F3-RAA17U-4T7,5	1000.4.17	400-50	7,5	15,4	1440	81,3	55	300	232
DF1000F3-RAA18U-4T11	1000.4.18	400-50	11	21,3	1440	81,3	55	300	316
DF1000F3-RAA19U-4T11	1000.4.19	400-50	11	21,3	1440	82	55	300	316
DF1000F3-RAA20U-4T11	1000.4.20	400-50	11	21,3	1440	86,5	55	300	326
DF1000F3-RAA21U-4T11	1000.4.21	400-50	11	21,3	1440	86,5	55	300	326
DF1000F3-RAA22U-4T15	1000.4.22	400-50	15	29,8	1440	85,5	55	300	337
DF1000F3-RAA23U-4T15	1000.4.23	400-50	15	29,8	1440	84,4	55	300	337
DF1000F3-RAA24U-4T22	1000.4.24	400-50	22	42,5	1440	85,5	55	300	386
DF1000F3-RAA25.AU-4T11	1000.4.25.A	400-50	11	21,3	1440	79,3	55	300	331
DF1000F3-RAA25.BU-4T15	1000.4.25.B	400-50	15	29,8	1440	79,3	55	300	342
DF1000F3-RAA26U-4T15	1000.4.26	400-50	15	29,8	1440	81	55	300	342
DF1000F3-RAA27U-4T22	1000.4.27	400-50	22	42,5	1440	82,4	55	300	391
DF1000F3-RAA28U-4T30	1000.4.28	400-50	30	55	1440	85,1	55	300	431
DF1000F3-RAA29U-4T22	1000.4.29	400-50	22	42,5	1440	83,5	55	300	391
DF1000F3-RAA30U-4T30	1000.4.30	400-50	30	55	1440	83,8	55	300	428

SMOKE AND HEAT EXTRACT FAN

MODEL	MODEL NUMBER	Voltage Frequency	Motor Power	Current	Rotation Speed	Sound Pressure	Protection Class	Working Range	Mass
		V-Hz	kW	A	RPM	Lp(A) dB at 3m	IP	°C	~ Kg
DF1000F3-RAA31U-4T7,5	1000.4.31	400-50	7,5	15,4	1440	84,8	55	300	231
DF1000F3-RAA32U-4T11	1000.4.32	400-50	11	21,3	1440	81,9	55	300	316
DF1000F3-RAA33U-4T15	1000.4.33	400-50	15	29,8	1440	81,4	55	300	327
DF1000F3-RAA34U-4T22	1000.4.34	400-50	22	42,5	1440	88,5	55	300	386
DF1000F3-RAA35U-4T22	1000.4.35	400-50	22	42,5	1440	88,5	55	300	386
DF1000F3-RAA36U-4T30	1000.4.36	400-50	30	55	1440	87,5	55	300	423
DF1000F3-RAA37U-4T37	1000.4.37	400-50	37	67	1440	86,5	55	300	510
DF1120F3-RAA1U-4T5,5	1120.4.1	400-50	5,5	11,2	1440	81,5	55	300	324
DF1120F3-RAA2U-4T7,5	1120.4.2	400-50	7,5	15,4	1440	82,1	55	300	335
DF1120F3-RAA3U-4T11	1120.4.3	400-50	11	21,3	1440	83,6	55	300	379
DF1120F3-RAA4U-4T11	1120.4.4	400-50	11	21,3	1440	83,8	55	300	375
DF1120F3-RAA5U-4T15	1120.4.5	400-50	15	29,8	1440	85,1	55	300	390
DF1120F3-RAA6U-4T18,5	1120.4.6	400-50	18,5	34,5	1440	86,5	55	300	450
DF1120F3-RAA7U-4T7,5	1120.4.7	400-50	7,5	15,4	1440	83,1	55	300	339
DF1120F3-RAA8U-4T11	1120.4.8	400-50	11	21,3	1440	86,5	55	300	379
DF1120F3-RAA9U-4T11	1120.4.9	400-50	11	21,3	1440	85,5	55	300	379
DF1120F3-RAA10U-4T15	1120.4.10	400-50	15	29,8	1440	84,3	55	300	390
DF1120F3-RAA11U-4T15	1120.4.11	400-50	15	29,8	1440	83,8	55	300	390
DF1120F3-RAA12U-4T18,5	1120.4.12	400-50	18,5	34,5	1440	85,5	55	300	450
DF1120F3-RAA13U-4T22	1120.4.13	400-50	22	42,5	1440	86,5	55	300	460
DF1120F3-RAA14U-4T22	1120.4.14	400-50	22	42,5	1440	87,5	55	300	460
DF1120F3-RAA15U-4T22	1120.4.15	400-50	22	42,5	1440	86,5	55	300	460
DF1120F3-RAA16U-4T11	1120.4.16	400-50	11	21,3	1440	88,5	55	300	379
DF1120F3-RAA17U-4T15	1120.4.17	400-50	15	29,8	1440	88,5	55	300	390
DF1120F3-RAA18U-4T15	1120.4.18	400-50	15	29,8	1440	88,5	55	300	390
DF1120F3-RAA19U-4T22	1120.4.19	400-50	22	42,5	1440	86,5	55	300	460
DF1120F3-RAA20U-4T30	1120.4.20	400-50	30	55	1440	89,5	55	300	497
DF1120F3-RAA21U-4T5,5	1120.4.21	400-50	5,5	11,2	1440	89,5	55	300	319
DF1120F3-RAA22U-4T7,5	1120.4.22	400-50	7,5	15,4	1440	89,5	55	300	330
DF1120F3-RAA23U-4T11	1120.4.23	400-50	11	21,3	1440	85,1	55	300	369
DF1120F3-RAA24U-4T15	1120.4.24	400-50	15	29,8	1440	84,6	55	300	380
DF1120F3-RAA25U-4T18,5	1120.4.25	400-50	18,5	34,5	1440	83,6	55	300	441
DF1120F3-RAA26U-4T11	1120.4.26	400-50	11	21,3	1440	89,5	55	300	384
DF1120F3-RAA27U-4T15	1120.4.27	400-50	15	29,8	1440	89,5	55	300	395
DF1120F3-RAA28U-4T15	1120.4.28	400-50	15	29,8	1440	88,5	55	300	395
DF1120F3-RAA29U-4T18,5	1120.4.29	400-50	18,5	34,5	1440	87,5	55	300	455
DF1120F3-RAA30U-4T18,5	1120.4.30	400-50	18,5	34,5	1440	87,5	55	300	455
DF1120F3-RAA31U-4T22	1120.4.31	400-50	22	42,5	1440	87,5	55	300	465
DF1120F3-RAA32U-4T30	1120.4.32	400-50	30	55	1440	86,5	55	300	502
DF1120F3-RAA33U-4T37	1120.4.33	400-50	37	67	1440	86,5	55	300	589
DF1120F3-RAA34U-4T22	1120.4.34	400-50	22	42,5	1440	88,5	55	300	460
DF1120F3-RAA35U-4T30	1120.4.35	400-50	30	55	1440	87,5	55	300	497
DF1120F3-RAA36U-4T15	1120.4.36	400-50	15	29,8	1440	90,5	55	300	401
DF1120F3-RAA37U-4T22	1120.4.37	400-50	22	42,5	1440	87,5	55	300	471
DF1120F3-RAA38U-4T45	1120.4.38	400-50	45	80	1440	87,5	55	300	641
DF1120F3-RAA39U-4T22	1120.4.39	400-50	22	42,5	1440	83,1	55	300	455

MODEL	MODEL NUMBER	Voltage Frequency	Motor Power	Current	Rotation Speed	Sound Pressure	Protection Class	Working Range	Mass
		V-Hz	kW	A	RPM	Lp(A) dB at 3m	IP	°C	~ Kg
DF1120F3-RAA40U-4T30	1120.4.40	400-50	30	55	1440	84,1	55	300	492
DF1250F3-RAA1U-4T11	1250.4.1	400-50	11	21,3	1440	89,5	55	300	405
DF1250F3-RAA2U-4T15	1250.4.2	400-50	15	29,8	1440	88,5	55	300	416
DF1250F3-RAA3U-4T18,5	1250.4.3	400-50	18,5	34,5	1440	88,5	55	300	455
DF1250F3-RAA4U-4T18,5	1250.4.4	400-50	18,5	34,5	1440	88,5	55	300	455
DF1250F3-RAA5U-4T22	1250.4.5	400-50	22	42,5	1440	88,5	55	300	465
DF1250F3-RAA6U-4T11	1250.4.6	400-50	11	21,3	1440	93,5	55	300	405
DF1250F3-RAA7U-4T18,5	1250.4.7	400-50	18,5	34,5	1440	94,5	55	300	455
DF1250F3-RAA8U-4T22	1250.4.8	400-50	22	42,5	1440	94,5	55	300	465
DF1250F3-RAA9U-4T22	1250.4.9	400-50	22	42,5	1440	94,5	55	300	465
DF1250F3-RAA10U-4T22	1250.4.10	400-50	22	42,5	1440	94,5	55	300	465
DF1250F3-RAA11U-4T30	1250.4.11	400-50	30	55	1440	92,5	55	300	540
DF1250F3-RAA12U-4T30	1250.4.12	400-50	30	55	1440	93,5	55	300	540
DF1250F3-RAA13U-4T30	1250.4.13	400-50	30	55	1440	87,5	55	300	540
DF1250F3-RAA14U-4T30	1250.4.14	400-50	30	55	1440	93,5	55	300	540
DF1250F3-RAA15U-4T30	1250.4.15	400-50	30	55	1440	88,5	55	300	540
DF1250F3-RAA16U-4T30	1250.4.16	400-50	30	55	1440	89,5	55	300	540
DF1250F3-RAA17U-4T37	1250.4.17	400-50	37	67	1440	89,5	55	300	627
DF1250F3-RAA18U-4T37	1250.4.18	400-50	37	67	1440	89,5	55	300	627
DF1250F3-RAA19U-4T37	1250.4.19	400-50	37	67	1440	89,5	55	300	627
DF1250F3-RAA20U-4T45	1250.4.20	400-50	45	80	1440	89,5	55	300	673
DF1250F3-RAA21U-4T45	1250.4.21	400-50	45	80	1440	89,5	55	300	673
DF1250F3-RAA22U-4T45	1250.4.22	400-50	45	80	1440	89,5	55	300	673
DF1250F3-RAA23U-4T45	1250.4.23	400-50	45	80	1440	47,5	55	300	673
DF1250F3-RAA24U-4T45	1250.4.24	400-50	45	80	1440	90,5	55	300	673
DF1250F3-RAA25U-4T55	1250.4.25	400-50	55	96,8	1440	91,5	55	300	758
DF1250F3-RAA26U-4T55	1250.4.26	400-50	55	96,8	1440	91,5	55	300	758
DF1250F3-RAA27U-4T55	1250.4.27	400-50	55	96,8	1440	91,5	55	300	758
DF1250F3-RAA28U-4T22	1250.4.28	400-50	22	42,5	1440	94,5	55	300	465
DF1250F3-RAA29.AU-4T22	1250.4.29.A	400-50	22	42,5	1440	94,5	55	300	465
DF1250F3-RAA29.BU-4T30	1250.4.29.B	400-50	30	55	1440	94,5	55	300	540
DF1250F3-RAA30U-4T30	1250.4.30	400-50	30	55	1440	92,5	55	300	540
DF1250F3-RAA31U-4T30	1250.4.31	400-50	30	55	1440	92,5	55	300	540
DF1250F3-RAA32U-4T45	1250.4.32	400-50	45	80	1440	90,5	55	300	673
DF1250F3-RAA33U-4T55	1250.4.33	400-50	55	96,8	1440	89,5	55	300	758
DF1250F3-RAA34U-4T55	1250.4.34	400-50	55	96,8	1440	89,5	55	300	758
DF1250F3-RAA35U-4T55	1250.4.35	400-50	55	96,8	1440	89,5	55	300	758
DF1250F3-RAA36U-4T11	1250.4.36	400-50	11	21,3	1440	82,5	55	300	410
DF1250F3-RAA37U-4T18,5	1250.4.37	400-50	18,5	34,5	1440	84,8	55	300	460
DF1250F3-RAA38U-4T22	1250.4.38	400-50	22	42,5	1440	85,4	55	300	470
DF1250F3-RAA39U-4T30	1250.4.39	400-50	30	55	1440	90,5	55	300	545
DF1250F3-RAA40U-4T30	1250.4.40	400-50	30	55	1440	91,5	55	300	545
DF1250F3-RAA41U-4T37	1250.4.41	400-50	37	67	1440	88,5	55	300	632
DF1250F3-RAA42U-4T37	1250.4.42	400-50	37	67	1440	89,5	55	300	632

SMOKE AND HEAT EXTRACT CABINET FANS



- Body is electrostatic powder painted for resistance to corrosion, optionally, the body can manufacture from hot dip galvanized sheet
- Double speed motor option,
- Adjustable blade angle
- Dynamically balanced aluminum impeller with heat treated high temperature resistance in accordance with ISO 1940
- Suitable for horizontal and vertical mounting
- Rotational speed can be set with frequency inverter
- Resistant to 300 degrees for 2 hours according to EN 12101-3 (No 2184-CPR-0031)

DRAGONFLY C - SYSTEM CURVE - 2 POLES

Ø400 / 3-4-5 Blade

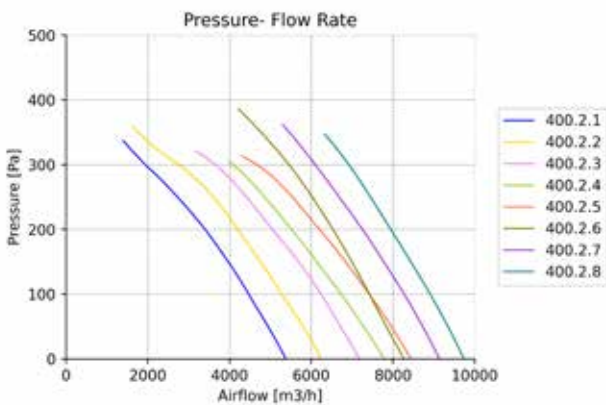

Ø400 / 6-8-10 Blade

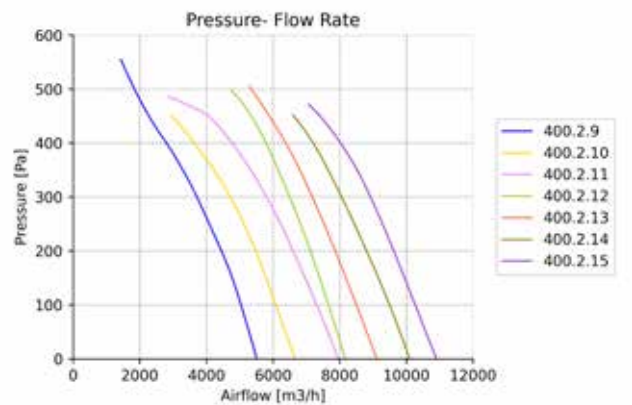

Ø450 / 3-4-6 Blade

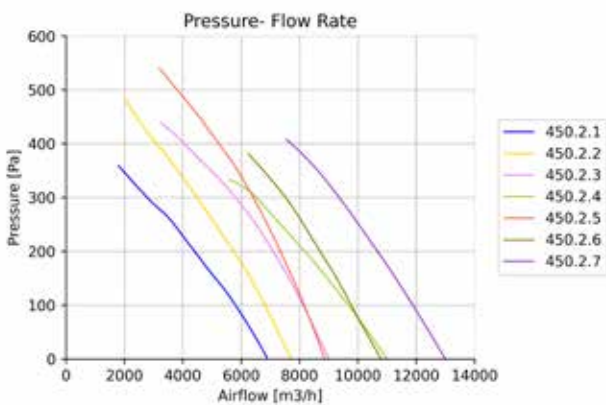

Ø450 / 5-6-8 Blade

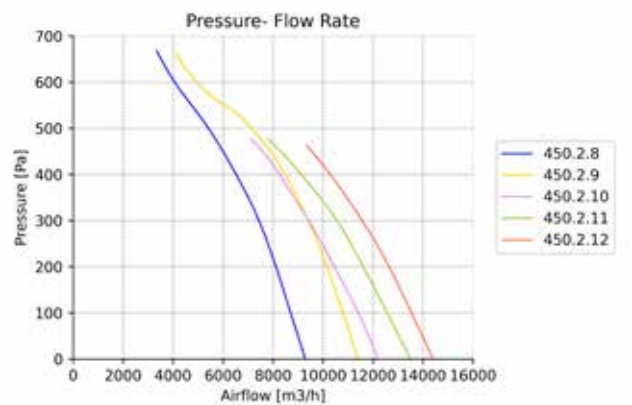

DRAGONFLY C - SYSTEM CURVE - 2 POLES

Ø450 / 10 Blade

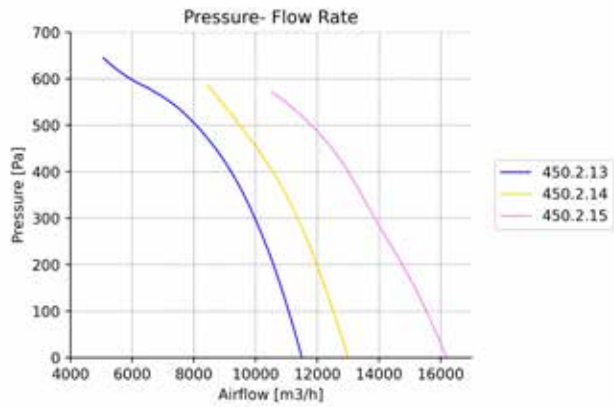

Ø500 / 3-4 Blade

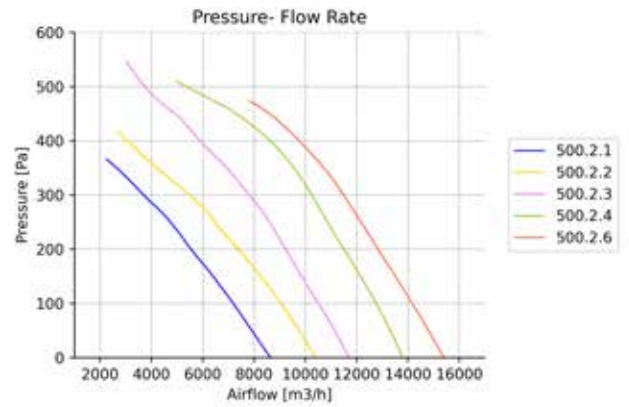

Ø500 / 5 Blade

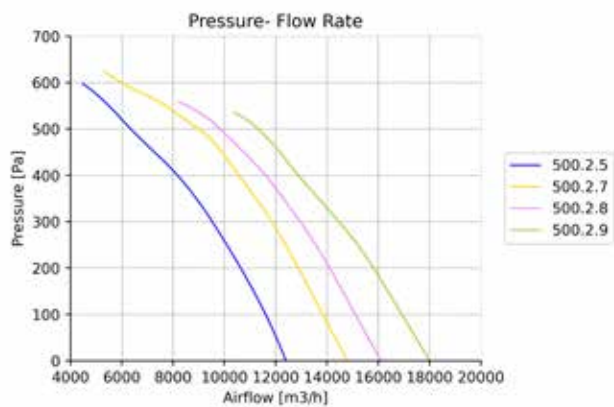

Ø500 / 10 Blade

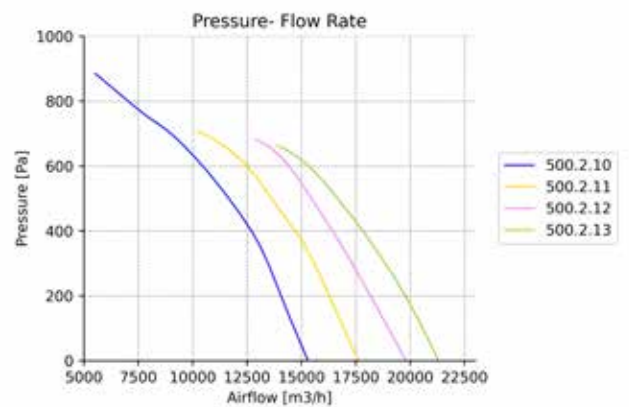

Ø560 / 3-4-5 Blade

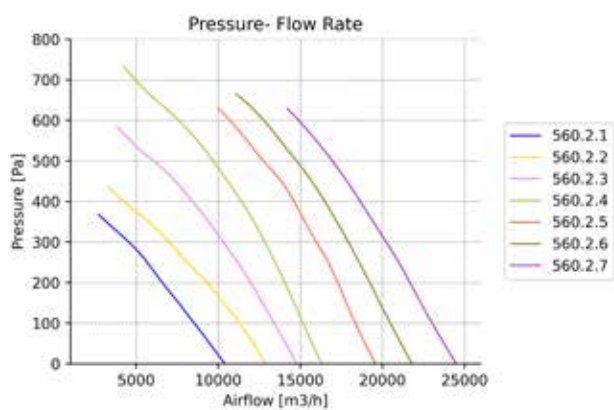

Ø560 / 6 Blade

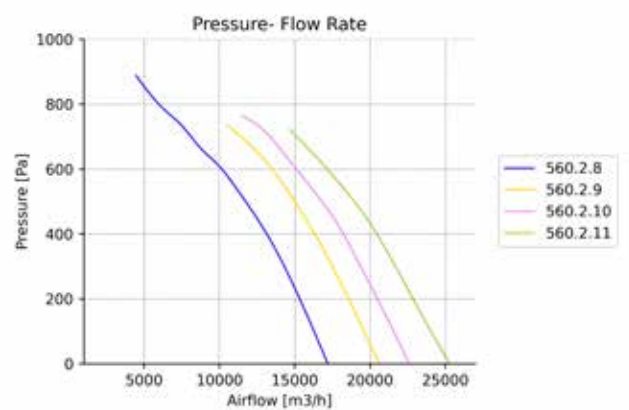

DRAGONFLY C - SYSTEM CURVE - 2 POLES

Ø560 / 10 Blade

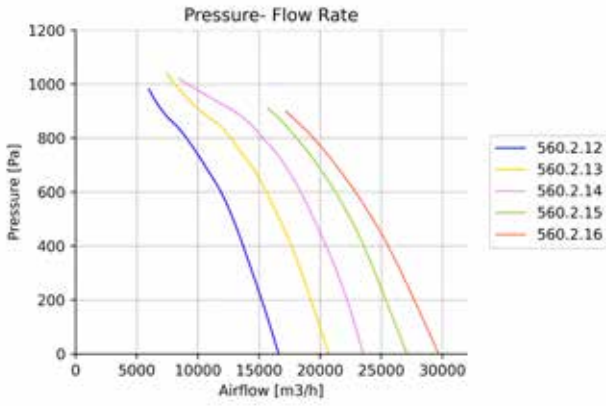

Ø630 / 3-4-5-6 Blade

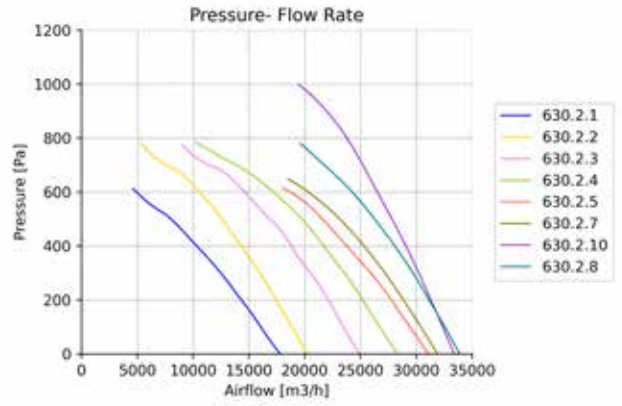

Ø630 / 6-10-12 Blade

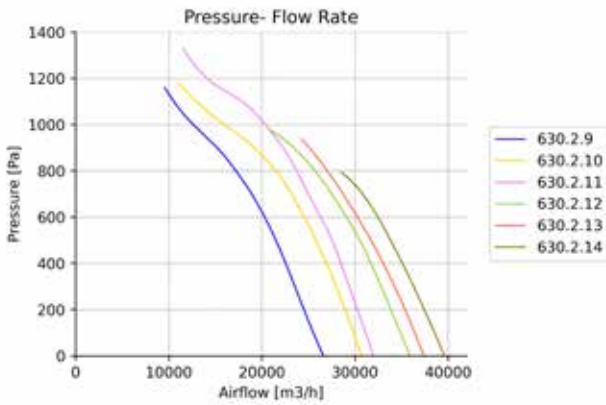

Ø710 / 3-6 Blade

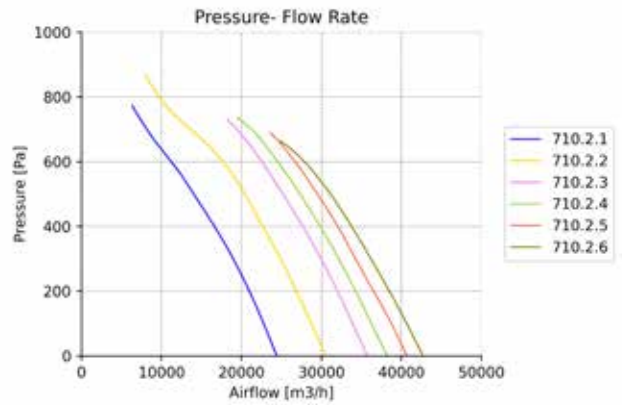

Ø710 / 6-12 Blade

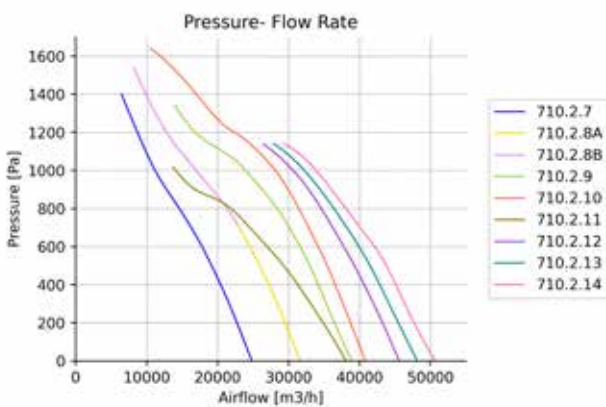

Ø800 / 3-6 Blade

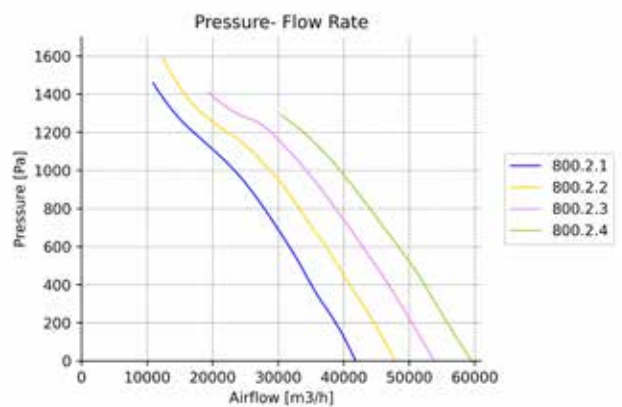

DRAGONFLY C - SYSTEM CURVE - 2 POLES

Ø800 / 6-6 Blade

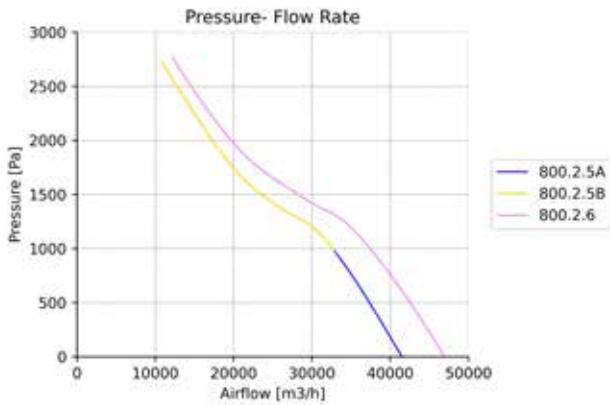

DRAGONFLY C - SYSTEM CURVE - 4 POLES

Ø400 / 6-8 Blade

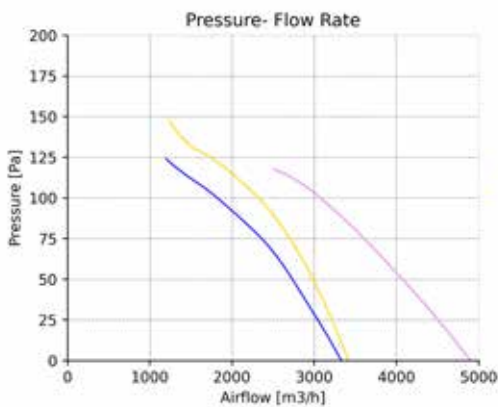

Ø450 / 6-8-10 Blade

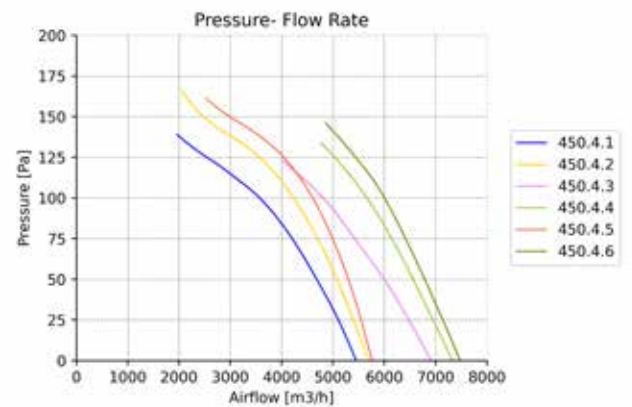

Ø500 / 6-8-10-12 Blade

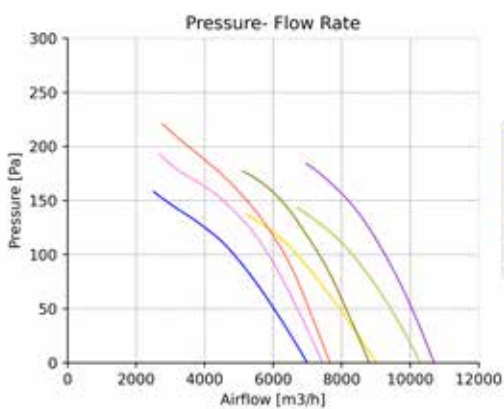

Ø560 / 3-4-6-8 Blade

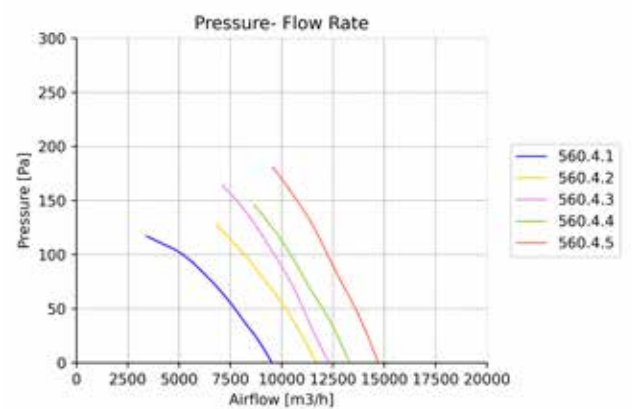

DRAGONFLY C - SYSTEM CURVE - 4 POLES

Ø560 / 10-12 Blade

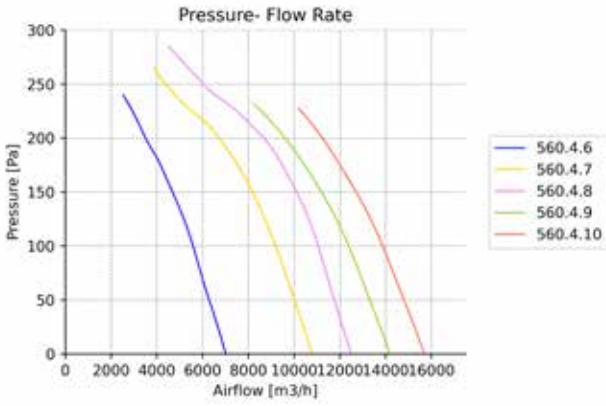

Ø630 / 5-6-8 Blade

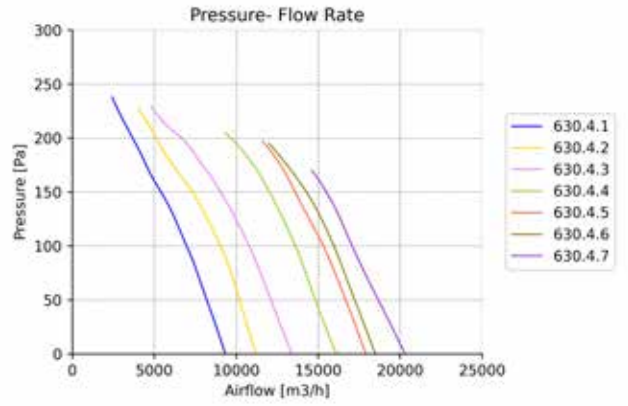

Ø630 / 10-12 Blade

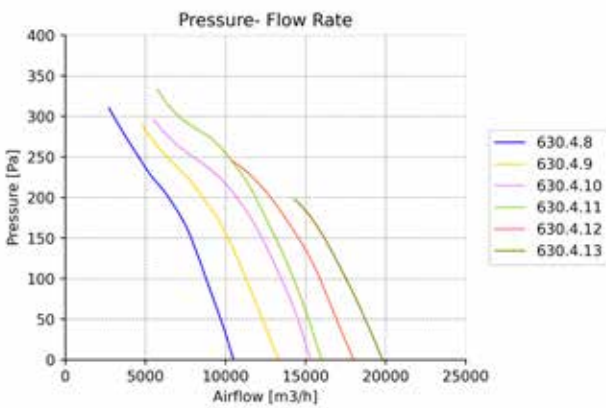

Ø630 / 9-12 Blade

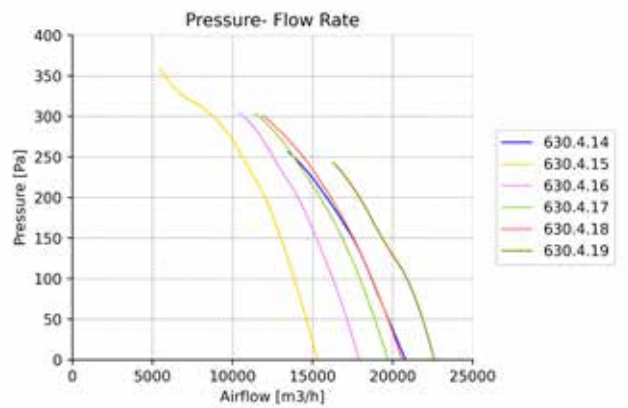

Ø710 / 5-6 Blade

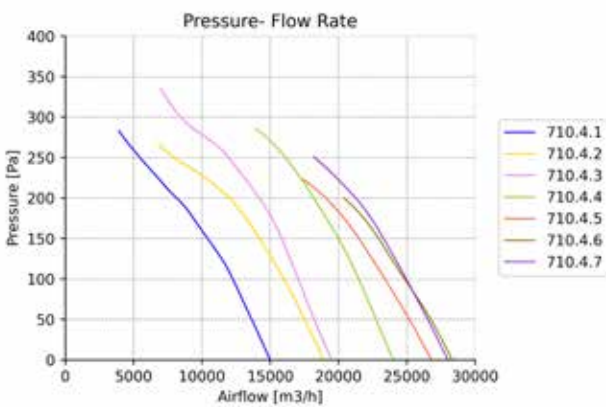

Ø710 / 9-12 Blade

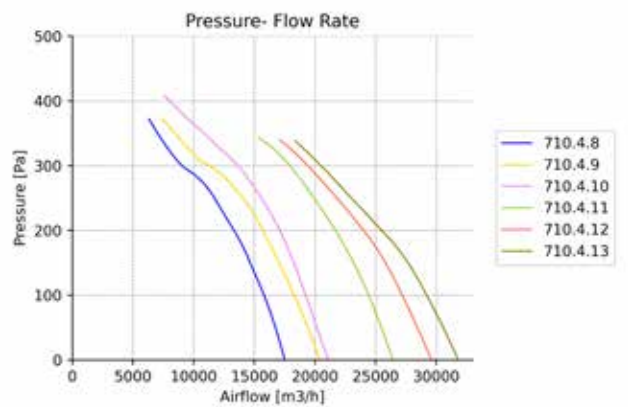

DRAGONFLY C - SYSTEM CURVE - 4 POLES

Ø800 / 6 Blade

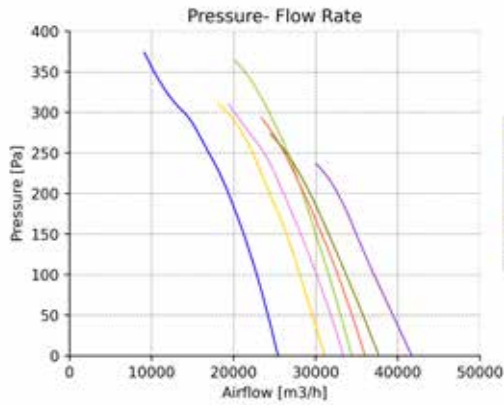

Ø800 / 8 Blade

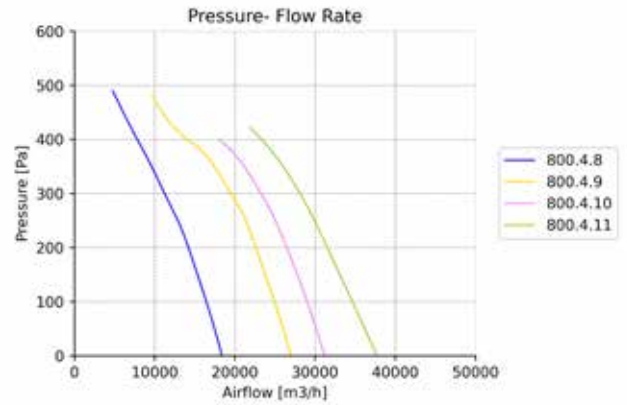

Ø800 / 9-12 Blade

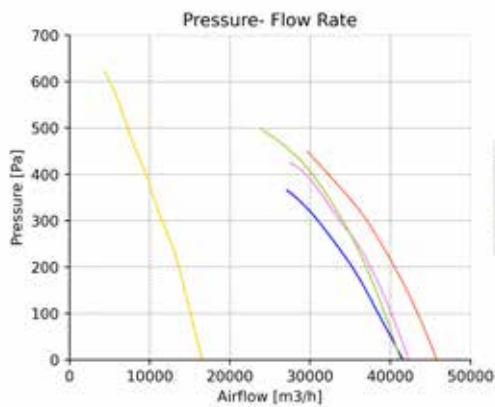

Ø800 / 6 Blade

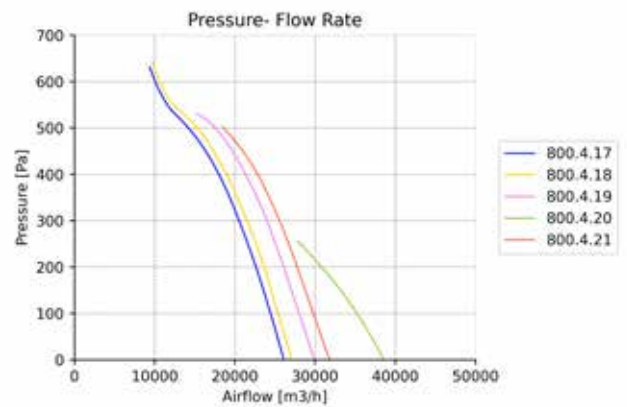

Ø900 / 6 Blade

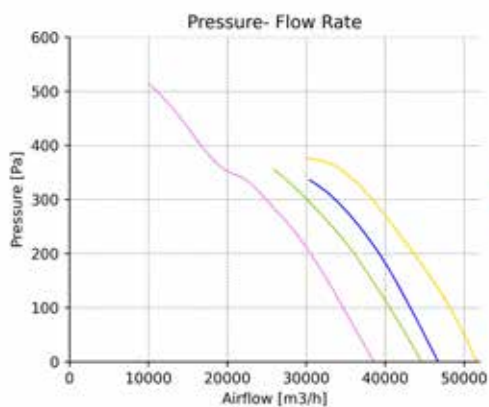

Ø900 / 8 Blade

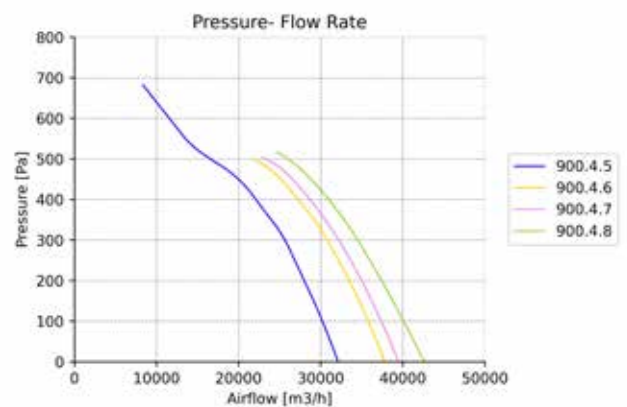

DRAGONFLY C - SYSTEM CURVE - 4 POLES

Ø900 / 9 Blade

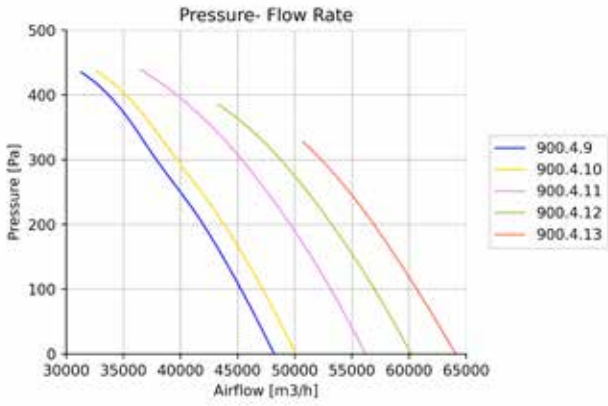

Ø900 / 12 Blade

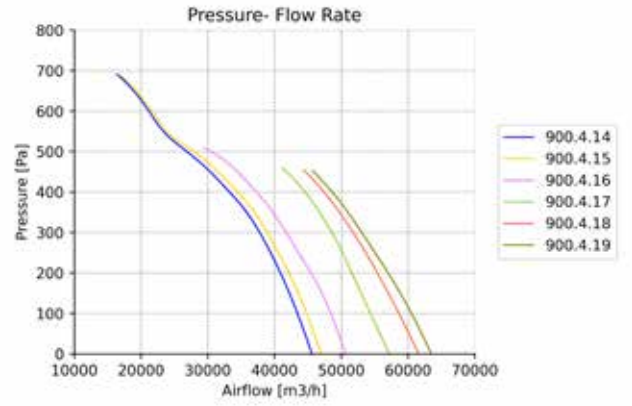

Ø900 / 6 Blade

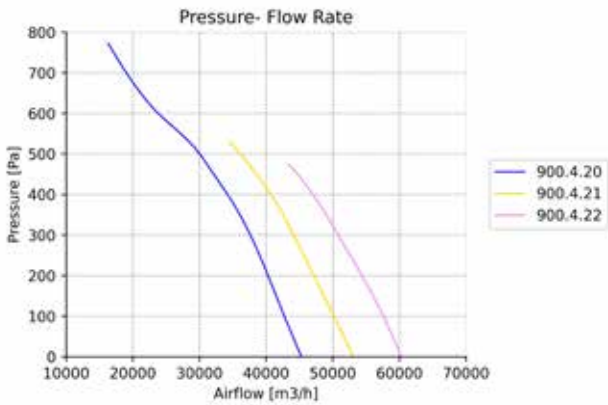

Ø1000 / 3 Blade

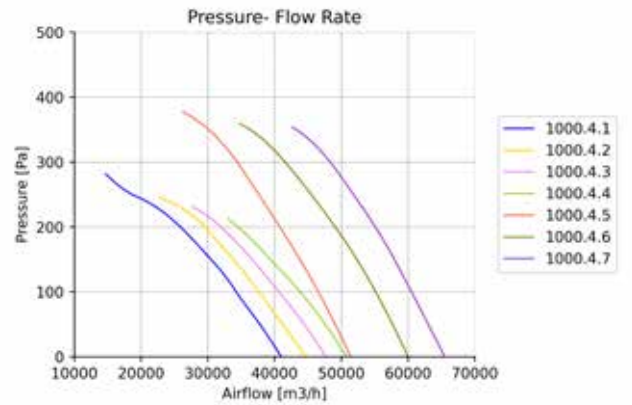

Ø1000 / 5-6 Blade

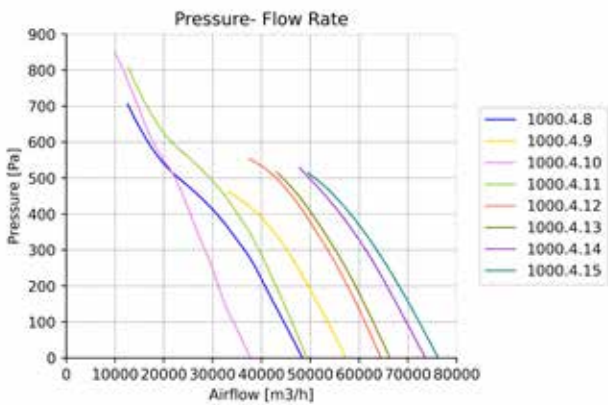

Ø1000 / 6 Blade

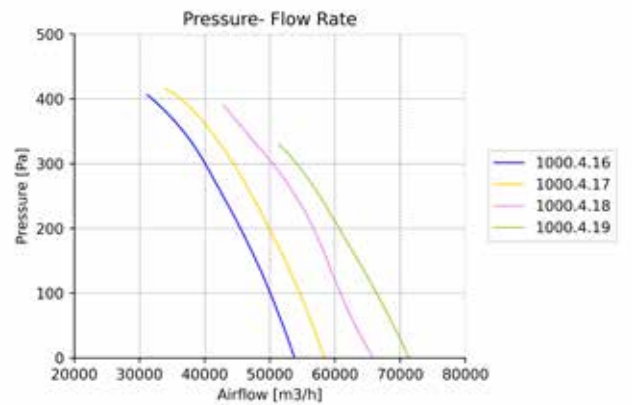

DRAGONFLY C - SYSTEM CURVE - 4 POLES

Ø1000 / 6 Blade

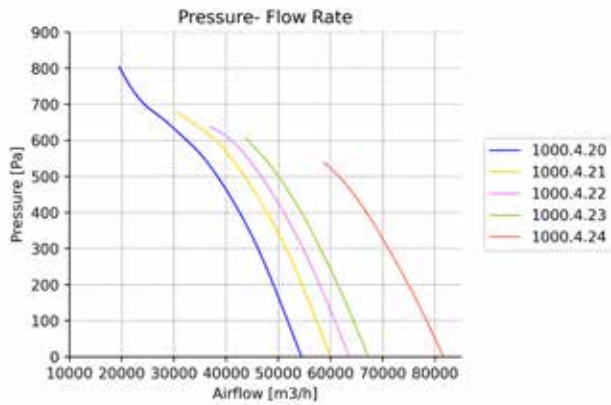

Ø1000 / 8 Blade

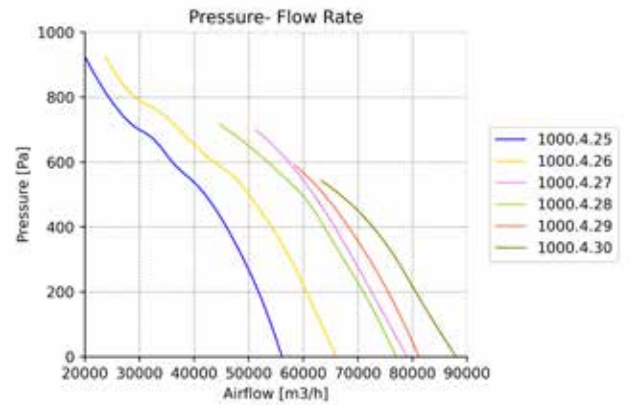

Ø1000 / 9 Blade

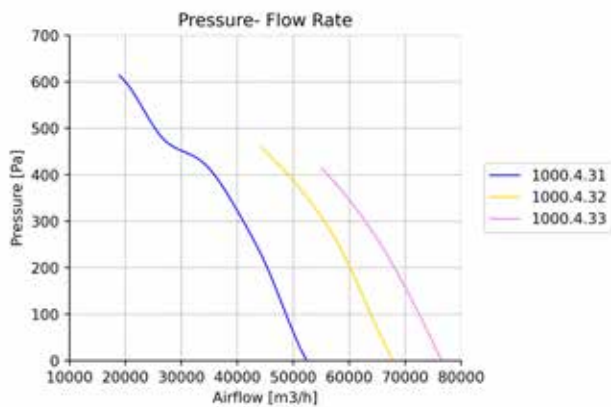

Ø1000 / 10 Blade

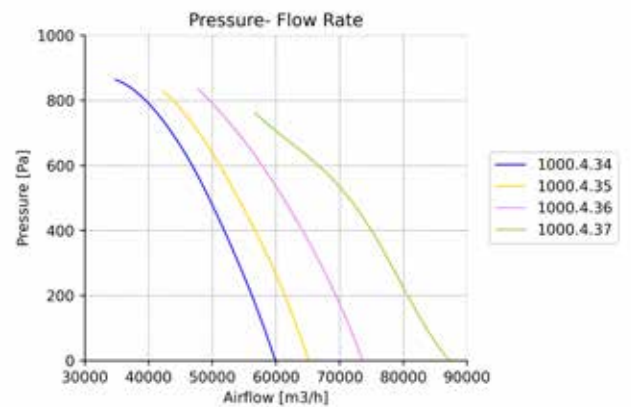

Ø1120 / 3 Blade

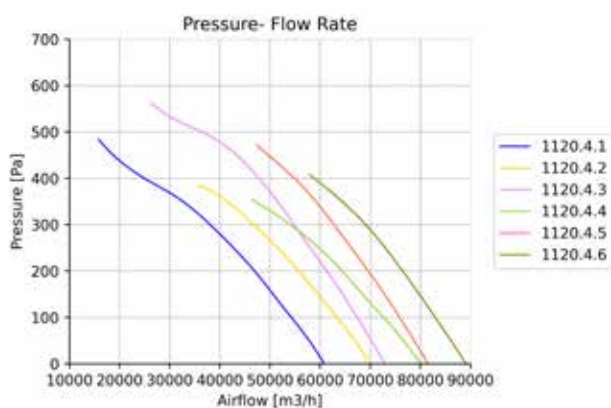

Ø1120 / 6 Blade

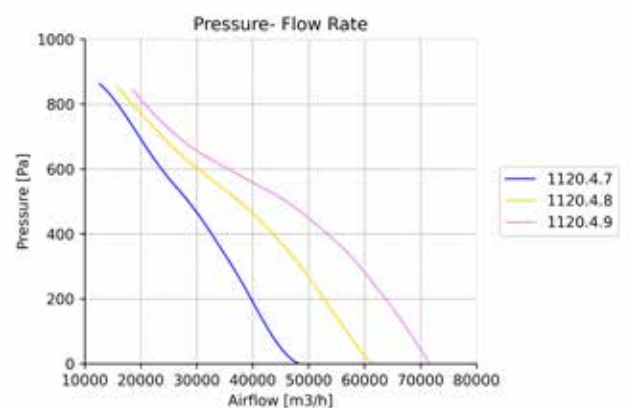

DRAGONFLY C - SYSTEM CURVE - 4 POLES

Ø1120 / 6 Blade

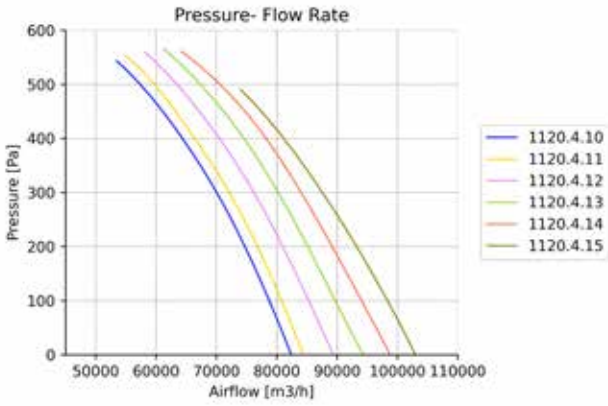

Ø1120 / 6 Blade

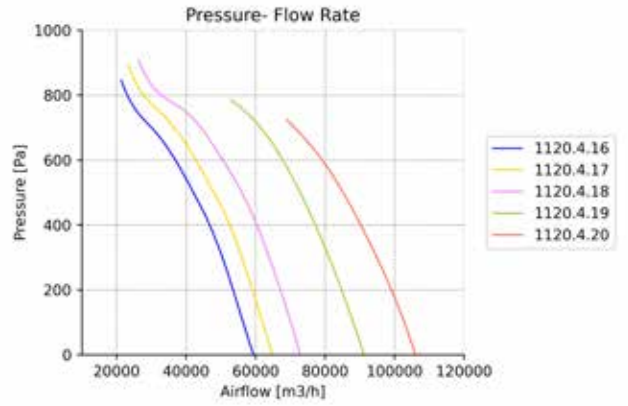

Ø1120 / 8 Blade

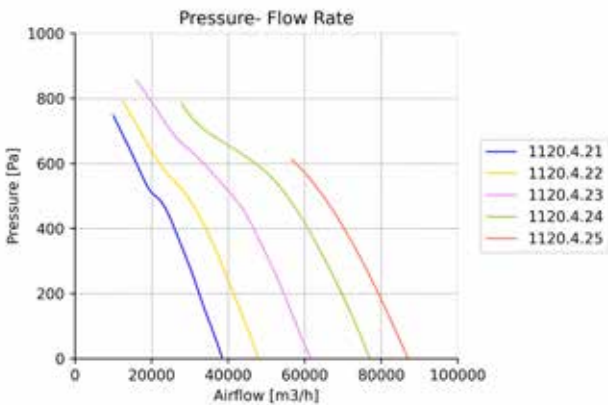

Ø1120 / 8 Blade

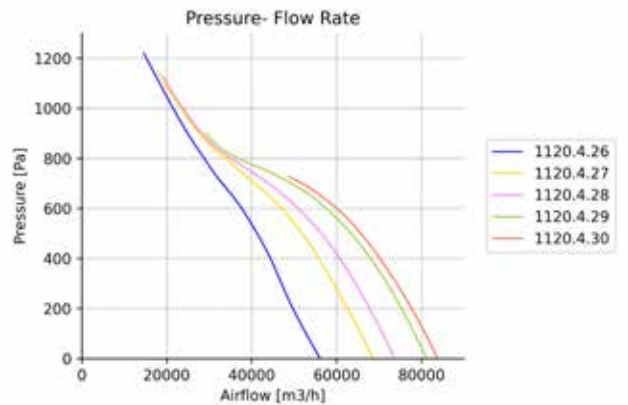

Ø1120 / 8 Blade

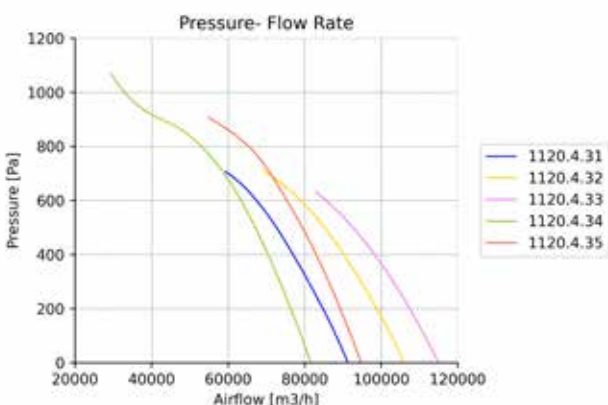

Ø1120 / 10-12 Blade

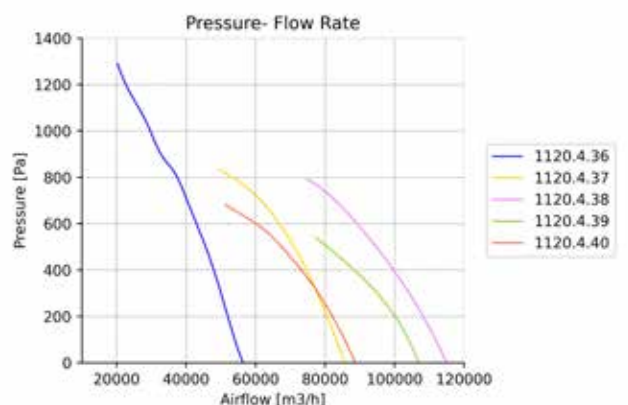

DRAGONFLY C - SYSTEM CURVE - 4 POLES

Ø1250 / 3 Blade

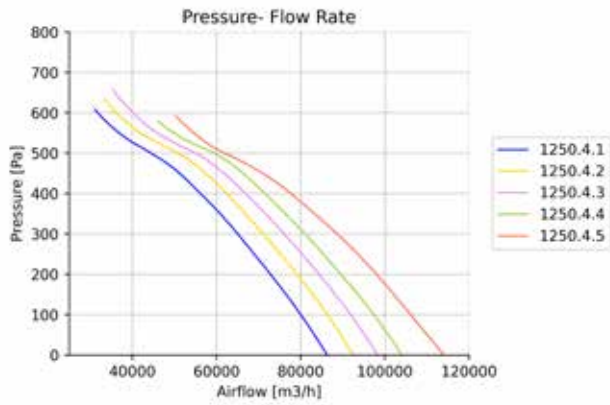

Ø1250 / 6 Blade

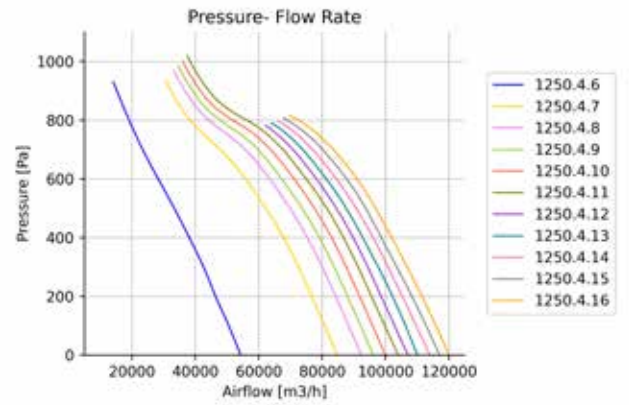

Ø1250 / 6 Blade

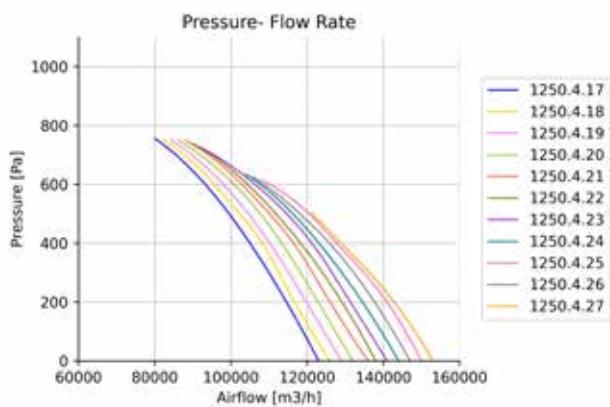

Ø1250 / 8 Blade

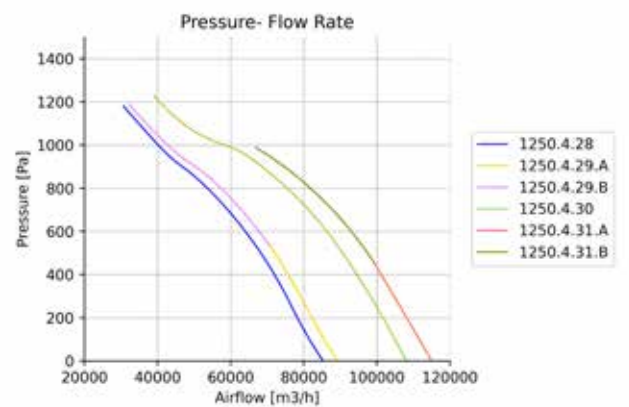

Ø1250 / 8 Blade

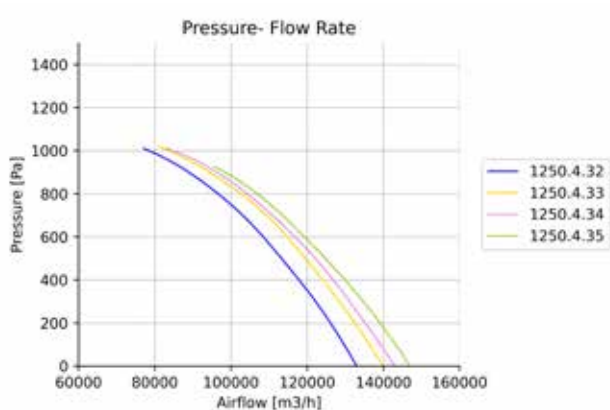

Ø1250 / 5 Blade

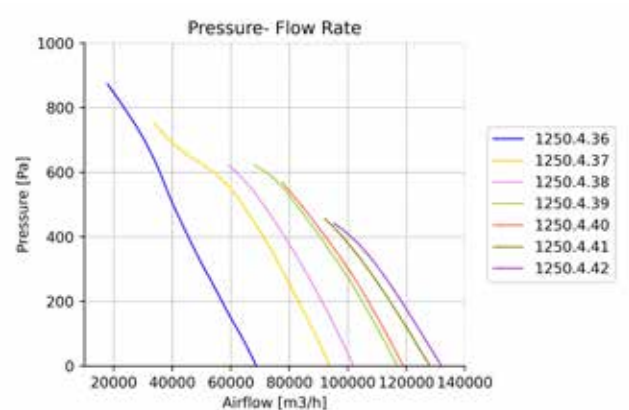

PRODUCT DIMENSIONS

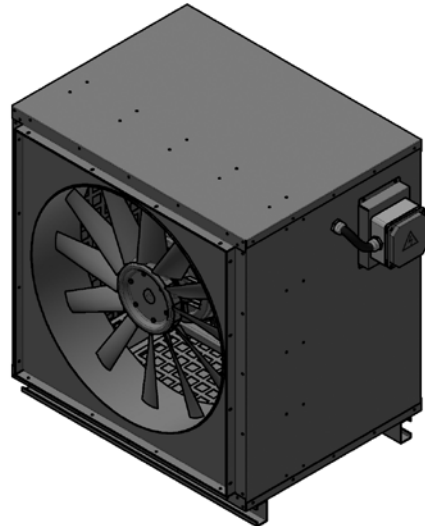
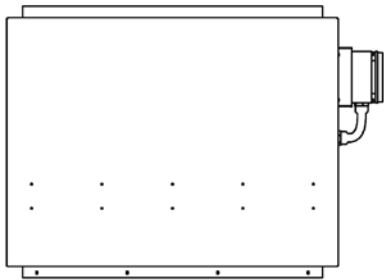
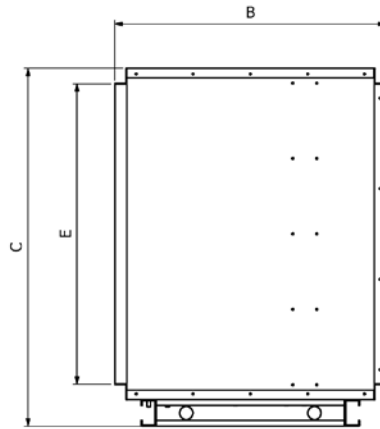
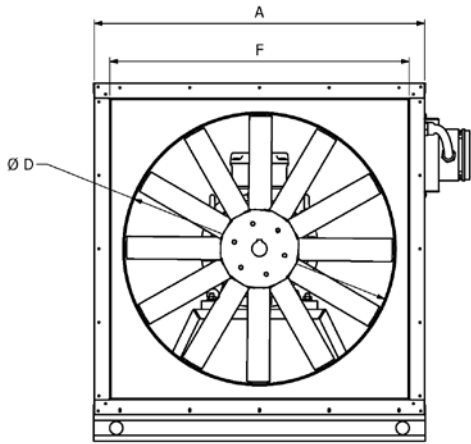

MODEL	A	B	C	ØD	E	F
DF400F3-CAA	670	600	740	400	590	590
DF450F3-CAA	670	600	740	450	590	590
DF500F3-CAA	670	600	740	500	590	590
DF560F3-CAA	800	650	870	560	720	720
DF630F3-CAA	800	650	870	630	720	720
DF710F3-CAA	880	720	950	710	800	800
DF800F3-CAA	970	720	1040	800	890	890
DF900F3-CAA	1170	800	1270	900	1070	1070
DF1000F3-CAA	1170	800	1270	1000	1070	1070
DF1120F3-CAA	1420	1000	1520	1120	1320	1320
DF1250F3-CAA	1420	1000	1520	1250	1320	1320

TECHNICAL PARAMETERS

MODEL	MODEL NUMBER	Voltage Frequency	Motor Power	Current	Rotation Speed	Sound Pressure	Protection Class	Working Range	Mass
		V-Hz	kW	A	RPM	Lp(A) dB at 3m	IP	°C	~ Kg
DF400F3-CAA1U-2T0,75	400.2.1	400-50	0,75	1,5	2880	60,5	55	300	76
DF400F3-CAA2U-2T0,75	400.2.2	400-50	0,75	1,6	2880	58,5	55	300	76
DF400F3-CAA3U-2T0,75	400.2.3	400-50	0,75	1,7	2880	59,8	55	300	75
DF400F3-CAA4U-2T0,75	400.2.4	400-50	0,75	1,7	2880	60,6	55	300	75
DF400F3-CAA5U-2T1,1	400.2.5	400-50	1,1	2,3	2880	63,2	55	300	77
DF400F3-CAA6U-2T1,1	400.2.6	400-50	1,1	2,3	2880	60,5	55	300	77
DF400F3-CAA7U-2T1,5	400.2.7	400-50	1,5	3,3	2880	63	55	300	81
DF400F3-CAA8U-2T2,2	400.2.8	400-50	2,2	4,5	2880	65,4	55	300	84
DF400F3-CAA9U-2T0,75	400.2.9	400-50	0,75	1,7	2880	63,6	55	300	75
DF400F3-CAA10U-2T0,75	400.2.10	400-50	0,75	1,7	2880	61,6	55	300	75
DF400F3-CAA11U-2T1,1	400.2.11	400-50	1,1	2,3	2880	60,2	55	300	76
DF400F3-CAA12U-2T1,5	400.2.12	400-50	1,5	3,3	2880	61,4	55	300	81
DF400F3-CAA13U-2T1,5	400.2.13	400-50	1,5	3,3	2880	61,2	55	300	81
DF400F3-CAA14U-2T2,2	400.2.14	400-50	2,2	4,5	2880	61,5	55	300	84
DF400F3-CAA15U-2T3	400.2.15	400-50	3	5,9	2880	64,3	55	300	92
DF450F3-CAA1U-2T0,75	450.2.1	400-50	0,75	1,6	2880	64	55	300	83
DF450F3-CAA2U-2T0,75	450.2.2	400-50	0,75	1,7	2880	67,9	55	300	82
DF450F3-CAA3U-2T1,1	450.2.3	400-50	1,1	2,3	2880	62,9	55	300	84
DF450F3-CAA4U-2T1,1	450.2.4	400-50	1,1	2,3	2880	64,3	55	300	84
DF450F3-CAA5U-2T1,1	450.2.5	400-50	1,1	2,3	2880	68	55	300	83
DF450F3-CAA6U-2T1,5	450.2.6	400-50	1,5	3,3	2880	62,3	55	300	88
DF450F3-CAA7U-2T2,2	450.2.7	400-50	2,2	4,5	2880	65,4	55	300	90
DF450F3-CAA8U-2T1,5	450.2.8	400-50	1,5	3,3	2880	67,3	55	300	88
DF450F3-CAA9U-2T2,2	450.2.9	400-50	2,2	4,5	2880	65,6	55	300	91
DF450F3-CAA10U-2T2,2	450.2.10	400-50	2,2	4,5	2880	64,9	55	300	91
DF450F3-CAA11U-2T3	450.2.11	400-50	3	5,9	2880	66	55	300	99
DF450F3-CAA12U-2T4	450.2.12	400-50	4	7,9	2880	69,2	55	300	104
DF450F3-CAA13U-2T3	450.2.13	400-50	3	5,9	2880	64,4	55	300	100
DF450F3-CAA14U-2T3	450.2.14	400-50	3	5,9	2880	64,4	55	300	100
DF450F3-CAA15U-2T5,5	450.2.15	400-50	5,5	10,3	2880	65,7	55	300	120
DF500F3-CAA1U-2T0,75	500.2.1	400-50	0,75	1,7	2880	71,3	55	300	90
DF500F3-CAA2U-2T1,1	500.2.2	400-50	1,1	2,3	2880	65,8	55	300	91
DF500F3-CAA3U-2T1,5	500.2.3	400-50	1,5	3,3	2880	67,2	55	300	96
DF500F3-CAA4U-2T2,2	500.2.4	400-50	2,2	4,5	2880	65,4	55	300	98
DF500F3-CAA5U-2T2,2	500.2.6	400-50	2,2	4,5	2880	64,9	55	300	98
DF500F3-CAA6U-2T2,2	500.2.5	400-50	2,2	4,5	2880	61,8	55	300	98
DF500F3-CAA7U-2T3	500.2.7	400-50	3	5,9	2880	65,4	55	300	106
DF500F3-CAA8U-2T3	500.2.8	400-50	3	5,9	2880	69	55	300	107
DF500F3-CAA9U-2T4	500.2.9	400-50	4	7,9	2880	69,5	55	300	111
DF500F3-CAA10U-2T4	500.2.10	400-50	4	7,9	2880	67,2	55	300	111
DF500F3-CAA11U-2T5,5	500.2.11	400-50	5,5	10,3	2880	66,9	55	300	127
DF500F3-CAA12U-2T7,5	500.2.12	400-50	7,5	13,6	2880	67,7	55	300	132
DF500F3-CAA13U-2T7,5	500.2.13	400-50	7,5	13,6	2880	67,7	55	300	132
DF560F3-CAA1U-2T0,75	560.2.1	400-50	0,75	1,7	2880	67,7	55	300	88
DF560F3-CAA2U-2T1,1	560.2.2	400-50	1,1	2,3	2880	65,4	55	300	89

MODEL	MODEL NUMBER	Voltage Frequency	Motor Power	Current	Rotation Speed	Sound Pressure	Protection Class	Working Range	Mass
		V-Hz	kW	A	RPM	Lp(A) dB at 3m	IP	°C	~ Kg
DF560F3-CAA3U-2T1,5	560.2.3	400-50	1,5	3,3	2880	68,7	55	300	94
DF560F3-CAA4U-2T2,2	560.2.4	400-50	2,2	5,9	2880	69	55	300	98
DF560F3-CAA5U-2T4	560.2.5	400-50	4	7,9	2880	67,7	55	300	111
DF560F3-CAA6U-2T4	560.2.6	400-50	4	7,9	2880	68,8	55	300	110
DF560F3-CAA7U-2T5,5	560.2.7	400-50	5,5	10,3	2880	70,6	55	300	126
DF560F3-CAA8U-2T3	560.2.8	400-50	3	5,9	2880	67,7	55	300	107
DF560F3-CAA9U-2T4	560.2.9	400-50	4	7,9	2880	68,2	55	300	111
DF560F3-CAA10U-2T5,5	560.2.10	400-50	5,5	10,3	2880	68,5	55	300	126
DF560F3-CAA11U-2T7,5	560.2.11	400-50	7,5	13,6	2880	70,3	55	300	131
DF560F3-CAA12U-2T4	560.2.12	400-50	4	7,9	2880	69,3	55	300	111
DF560F3-CAA13U-2T5,5	560.2.13	400-50	5,5	10,3	2880	70,7	55	300	126
DF560F3-CAA14U-2T7,5	560.2.14	400-50	7,5	13,6	2880	69,4	55	300	131
DF560F3-CAA15U-2T11	560.2.15	400-50	11	19,5	2880	70,1	55	300	181
DF560F3-CAA16U-2T11	560.2.16	400-50	11	19,5	2880	69,8	55	300	181
DF630F3-CAA1U-2T2,2	630.2.1	400-50	2,2	4,5	2880	68,7	55	300	110
DF630F3-CAA2U-2T3	630.2.2	400-50	3	5,9	2880	69,8	55	300	119
DF630F3-CAA3U-2T5,5	630.2.3	400-50	5,5	10,3	2880	68,2	55	300	139
DF630F3-CAA4U-2T5,5	630.2.4	400-50	5,5	10,3	2880	70,3	55	300	139
DF630F3-CAA5U-2T7,5	630.2.5	400-50	7,5	13,6	2880	73,5	55	300	144
DF630F3-CAA6U-2T7,5	630.2.6	400-50	7,5	13,6	2880	71,4	55	300	143
DF630F3-CAA7U-2T11	630.2.7	400-50	11	19,5	2880	73,7	55	300	195
DF630F3-CAA8U-2T11	630.2.8	400-50	11	19,5	2880	71,7	55	300	194
DF630F3-CAA9U-2T7,5	630.2.9	400-50	7,5	13,6	2880	73,4	55	300	144
DF630F3-CAA10U-2T11	630.2.10	400-50	11	19,5	2880	71,6	55	300	194
DF630F3-CAA11U-2T11	630.2.11	400-50	11	19,5	2880	71,7	55	300	194
DF630F3-CAA12U-2T15	630.2.12	400-50	15	28,3	2880	71,6	55	300	202
DF630F3-CAA13U-2T15	630.2.13	400-50	15	28,3	2880	73,7	55	300	202
DF630F3-CAA14U-2T15	630.2.14	400-50	15	28,3	2880	71,5	55	300	202
DF710F3-CAA1U-2T3	710.2.1	400-50	3	5,9	2880	74,8	55	300	118
DF710F3-CAA2U-2T5,5	710.2.2	400-50	5,5	10,3	2880	72	55	300	138
DF710F3-CAA3U-2T7,5	710.2.3	400-50	7,5	13,6	2880	72,3	55	300	144
DF710F3-CAA4U-2T7,5	710.2.4	400-50	7,5	13,6	2880	73,1	55	300	144
DF710F3-CAA5U-2T11	710.2.5	400-50	11	19,5	2880	73,9	55	300	193
DF710F3-CAA6U-2T11	710.2.6	400-50	11	19,5	2880	74,9	55	300	193
DF710F3-CAA7U-2T5,5	710.2.7	400-50	5,5	10,3	2880	82,5	55	300	139
DF710F3-CAA8.AU-2T7,5	710.2.8A	400-50	7,5	13,6	2880	78,5	55	300	144
DF710F3-CAA8.BU-2T11	710.2.8B	400-50	11	19,5	2880	78,5	55	300	194
DF710F3-CAA9U-2T15	710.2.9	400-50	15	28,3	2880	71,4	55	300	203
DF710F3-CAA10U-2T11	710.2.10	400-50	11	19,5	2880	76,5	55	300	194
DF710F3-CAA11U-2T15	710.2.11	400-50	15	28,3	2880	73,3	55	300	206
DF710F3-CAA12U-2T15	710.2.12	400-50	15	28,3	2880	76,5	55	300	202
DF710F3-CAA13U-2T18,5	710.2.13	400-50	18,5	32,3	2880	77,5	55	300	223
DF710F3-CAA14U-2T18,5	710.2.14	400-50	18,5	32,3	2880	77,5	55	300	223
DF800F3-CAA1U-2T11	800.2.1	400-50	11	19,5	2880	77,5	55	300	214
DF800F3-CAA2U-2T15	800.2.2	400-50	15	28,3	2880	78,5	55	300	222
DF800F3-CAA3U-2T18,5	800.2.3	400-50	18,5	32,3	2880	80,5	55	300	245

MODEL	MODEL NUMBER	Voltage Frequency	Motor Power	Current	Rotation Speed	Sound Pressure	Protection Class	Working Range	Mass
		V-Hz	kW	A	RPM	Lp(A) dB at 3m	IP	°C	~ Kg
DF800F3-CAA4U-2T22	800.2.4	400-50	22	38,3	2880	81,5	55	300	280
DF800F3-CAA5U-2T18,5	800.2.5	400-50	18,5	32,3	2880	81,5	55	300	239
DF800F3-CAA6U-2T18,5	800.2.6	400-50	18,5	32,3	2880	81,5	55	300	239
DF800F3-CAA7U-2T22	800.2.7	400-50	22	38,3	2880	81,5	55	300	274
DF400F3-CAA1U-4T0,75	400.4.1	400-50	0,75	1,13	1440	46,5	55	300	74
DF400F3-CAA2U-4T0,75	400.4.2	400-50	0,75	1,13	1440	46,7	55	300	75
DF400F3-CAA3U-4T0,75	400.4.3	400-50	0,75	1,13	1440	47,6	55	300	74
DF450F3-CAA1U-4T0,75	450.4.1	400-50	0,75	1,13	1440	48,7	55	300	77
DF450F3-CAA2U-4T0,75	450.4.2	400-50	0,75	1,13	1440	50,6	55	300	78
DF450F3-CAA3U-4T0,75	450.4.3	400-50	0,75	1,13	1440	50,7	55	300	77
DF450F3-CAA4U-4T0,75	450.4.4	400-50	0,75	1,55	1440	49,4	55	300	78
DF450F3-CAA5U-4T0,75	450.4.5	400-50	0,75	1,13	1440	49,4	55	300	79
DF450F3-CAA6U-4T0,75	450.4.6	400-50	0,75	1,55	1440	49,4	55	300	79
DF450F3-CAA7U-4T0,75	450.4.7	400-50	0,75	2	1440	49,5	55	300	79
DF500F3-CAA1U-4T0,75	500.4.1	400-50	0,75	1,13	1440	47,7	55	300	82
DF500F3-CAA2U-4T0,75	500.4.2	400-50	0,75	1,55	1440	52,5	55	300	82
DF500F3-CAA3U-4T0,75	500.4.3	400-50	0,75	1,13	1440	53,6	55	300	82
DF500F3-CAA4U-4T0,75	500.4.4	400-50	0,75	2	1440	52,8	55	300	82
DF500F3-CAA5U-4T0,75	500.4.5	400-50	0,75	1,55	1440	53,8	55	300	82
DF500F3-CAA6U-4T0,75	500.4.6	400-50	0,75	2	1440	53,8	55	300	82
DF500F3-CAA7U-4T1,1	500.4.7	400-50	1,1	2,6	1440	54,5	55	300	97
DF560F3-CAA1U-4T0,75	560.4.1	400-50	0,75	1,13	1440	54,6	55	300	91
DF560F3-CAA2U-4T0,75	560.4.2	400-50	0,75	1,55	1440	54,2	55	300	92
DF560F3-CAA3U-4T0,75	560.4.3	400-50	0,75	2	1440	55,5	55	300	92
DF560F3-CAA4U-4T0,75	560.4.4	400-50	0,75	2	1440	56	55	300	92
DF560F3-CAA5U-4T1,1	560.4.5	400-50	1,1	2,6	1440	55,7	55	300	96
DF560F3-CAA6U-4T0,75	560.4.6	400-50	0,75	1,13	1440	56,3	55	300	93
DF560F3-CAA7U-4T0,75	560.4.7	400-50	0,75	2	1440	55,8	55	300	93
DF560F3-CAA8U-4T1,1	560.4.8	400-50	1,1	2,6	1440	54,8	55	300	98
DF560F3-CAA9U-4T1,1	560.4.9	400-50	1,1	2,6	1440	55,3	55	300	97
DF560F3-CAA10U-4T1,5	560.4.10	400-50	1,5	3,5	1440	56,2	55	300	101
DF630F3-CAA1U-4T0,75	630.4.1	400-50	0,75	1,55	1440	56,4	55	300	92
DF630F3-CAA2U-4T0,75	630.4.2	400-50	0,75	1,55	1440	56	55	300	92
DF630F3-CAA3U-4T0,75	630.4.3	400-50	0,75	2	1440	54,2	55	300	92
DF630F3-CAA4U-4T1,1	630.4.4	400-50	1,1	2,6	1440	57,6	55	300	97
DF630F3-CAA5U-4T1,5	630.4.5	400-50	1,5	3,5	1440	58,4	55	300	101
DF630F3-CAA6U-4T1,5	630.4.6	400-50	1,5	2	1440	57,2	55	300	100
DF630F3-CAA7U-4T2,2	630.4.7	400-50	2,2	5	1440	61,1	55	300	108
DF630F3-CAA8U-4T0,75	630.4.8	400-50	0,75	2	1440	57,8	55	300	93
DF630F3-CAA9U-4T0,75	630.4.9	400-50	0,75	2	1440	63	55	300	93
DF630F3-CAA10U-4T1,1	630.4.10	400-50	1,1	2,6	1440	56,5	55	300	98
DF630F3-CAA11U-4T1,5	630.4.11	400-50	1,5	3,5	1440	56,4	55	300	101
DF630F3-CAA12U-4T1,5	630.4.12	400-50	1,5	3,5	1440	57	55	300	101
DF630F3-CAA13U-4T2,2	630.4.13	400-50	2,2	5	1440	58	55	300	108
DF630F3-CAA14U-4T2,2	630.4.14	400-50	2,2	5	1440	58,1	55	300	108
DF630F3-CAA15U-4T1,5	630.4.15	400-50	1,5	3,5	1440	61,3	55	300	103

MODEL	MODEL NUMBER	Voltage Frequency	Motor Power	Current	Rotation Speed	Sound Pressure	Protection Class	Working Range	Mass
		V-Hz	kW	A	RPM	Lp(A) dB at 3m	IP	°C	~ Kg
DF630F3-CAA16U-4T2,2	630.4.16	400-50	2,2	5	1440	61,2	55	300	110
DF630F3-CAA17U-4T2,2	630.4.17	400-50	2,2	5	1440	61,1	55	300	110
DF630F3-CAA18U-4T2,2	630.4.18	400-50	2,2	5	1440	61,4	55	300	110
DF630F3-CAA19U-4T3	630.4.19	400-50	3	6,6	1440	62,8	55	300	117
DF710F3-CAA1U-4T0,75	710.4.1	400-50	0,75	2	1440	61,8	55	300	105
DF710F3-CAA2U-4T1,5	710.4.2	400-50	1,5	3,5	1440	59	55	300	113
DF710F3-CAA3U-4T1,5	710.4.3	400-50	1,5	3,5	1440	61,9	55	300	114
DF710F3-CAA4U-4T2,2	710.4.4	400-50	2,2	5	1440	62	55	300	121
DF710F3-CAA5U-4T3	710.4.5	400-50	3	6,6	1440	62,8	55	300	127
DF710F3-CAA6U-4T3	710.4.6	400-50	3	6,6	1440	63,5	55	300	127
DF710F3-CAA7U-4T3	710.4.7	400-50	3	6,6	1440	64,1	55	300	128
DF710F3-CAA8U-4T1,5	710.4.8	400-50	1,5	3,5	1440	59,8	55	300	118
DF710F3-CAA9U-4T2,2	710.4.9	400-50	2,2	5	1440	58,2	55	300	125
DF710F3-CAA10U-4T2,2	710.4.10	400-50	2,2	5	1440	63,8	55	300	123
DF710F3-CAA11U-4T3	710.4.11	400-50	3	6,6	1440	63	55	300	130
DF710F3-CAA12U-4T4	710.4.12	400-50	4	8,4	1440	63,5	55	300	140
DF710F3-CAA13U-4T4	710.4.13	400-50	4	8,4	1440	62,5	55	300	138
DF710F3-CAA14U-4T5,5	710.4.14	400-50	5,5	11,2	1440	63,5	55	300	146
DF800F3-CAA1U-4T2,2	800.4.1	400-50	2,2	5	1440	66,8	55	300	136
DF800F3-CAA2U-4T3	800.4.2	400-50	3	6,6	1440	65	55	300	142
DF800F3-CAA3U-4T3	800.4.3	400-50	3	6,6	1440	64,1	55	300	141
DF800F3-CAA4U-4T4	800.4.4	400-50	4	8,4	1440	65,1	55	300	153
DF800F3-CAA5U-4T4	800.4.5	400-50	4	8,4	1440	65,3	55	300	153
DF800F3-CAA6U-4T4	800.4.6	400-50	4	8,4	1440	64,6	55	300	152
DF800F3-CAA7U-4T5,5	800.4.7	400-50	5,5	11,2	1440	66,1	55	300	162
DF800F3-CAA8U-4T5,5	800.4.8	400-50	5,5	11,2	1440	66,8	55	300	160
DF800F3-CAA9U-4T1,5	800.4.9	400-50	1,5	3,5	1440	69,2	55	300	129
DF800F3-CAA10U-4T3	800.4.10	400-50	3	6,6	1440	68,1	55	300	142
DF800F3-CAA11U-4T4	800.4.11	400-50	4	8,4	1440	66,7	55	300	153
DF800F3-CAA12U-4T5,5	800.4.12	400-50	5,5	11,2	1440	65,7	55	300	162
DF800F3-CAA13U-4T7,5	800.4.13	400-50	7,5	15,4	1440	66,7	55	300	173
DF800F3-CAA14U-4T2,2	800.4.14	400-50	2,2	5	1440	68,3	55	300	136
DF800F3-CAA15U-4T11	800.4.15	400-50	11	21,3	1440	67,1	55	300	237
DF800F3-CAA16U-4T7,5	800.4.16	400-50	7,5	15,4	1440	66,9	55	300	173
DF800F3-CAA17U-4T11	800.4.17	400-50	11	21,3	1440	67,4	55	300	237
DF800F3-CAA18U-4T4	800.4.18	400-50	4	8,4	1440	67,8	55	300	163
DF800F3-CAA19U-4T4	800.4.19	400-50	4	8,4	1440	68	55	300	163
DF800F3-CAA20U-4T5,5	800.4.20	400-50	5,5	11,2	1440	67,5	55	300	171
DF800F3-CAA21U-4T5,5	800.4.21	400-50	5,5	11,2	1440	66,9	55	300	171
DF900F3-CAA1U-4T5,5	900.4.1	400-50	5,5	11,2	1440	72,7	55	300	164
DF900F3-CAA2U-4T7,5	900.4.2	400-50	7,5	15,4	1440	66,5	55	300	175
DF900F3-CAA3U-4T4	900.4.3	400-50	4	8,4	1440	66,3	55	300	155
DF900F3-CAA4U-4T5,5	900.4.4	400-50	5,5	11,2	1440	66,4	55	300	163
DF900F3-CAA5U-4T4	900.4.5	400-50	4	8,4	1440	69,9	55	300	155
DF900F3-CAA6U-4T5,5	900.4.6	400-50	5,5	11,2	1440	69,1	55	300	163
DF900F3-CAA7U-4T7,5	900.4.7	400-50	7,5	15,4	1440	69,2	55	300	174

MODEL	MODEL NUMBER	Voltage Frequency	Motor Power	Current	Rotation Speed	Sound Pressure	Protection Class	Working Range	Mass
		V-Hz	kW	A	RPM	Lp(A) dB at 3m	IP	°C	~ Kg
DF900F3-CAA8U-4T7,5	900.4.8	400-50	7,5	15,4	1440	67,7	55	300	174
DF900F3-CAA9U-4T7,5	900.4.9	400-50	7,5	15,4	1440	68,5	55	300	174
DF900F3-CAA10U-4T7,5	900.4.10	400-50	7,5	15,4	1440	69,2	55	300	174
DF900F3-CAA11U-4T11	900.4.11	400-50	11	21,3	1440	68,8	55	300	235
DF900F3-CAA12U-4T11	900.4.12	400-50	11	21,3	1440	68,9	55	300	235
DF900F3-CAA13U-4T15	900.4.13	400-50	15	29,8	1440	68	55	300	246
DF900F3-CAA14U-4T7,5	900.4.14	400-50	7,5	15,4	1440	69,1	55	300	178
DF900F3-CAA15U-4T7,5	900.4.15	400-50	7,5	15,4	1440	71,9	55	300	178
DF900F3-CAA16U-4T11	900.4.16	400-50	11	21,3	1440	73,8	55	300	239
DF900F3-CAA17U-4T15	900.4.17	400-50	15	29,8	1440	69,7	55	300	251
DF900F3-CAA18U-4T15	900.4.18	400-50	15	29,8	1440	69,5	55	300	251
DF900F3-CAA19U-4T15	900.4.19	400-50	15	29,8	1440	70,3	55	300	251
DF900F3-CAA20U-4T11	900.4.20	400-50	11	21,3	1440	69,4	55	300	245
DF900F3-CAA21U-4T11	900.4.21	400-50	11	21,3	1440	69,4	55	300	245
DF900F3-CAA22U-4T15	900.4.22	400-50	15	29,8	1440	67,6	55	300	256
DF1000F3-CAA1U-4T3	1000.4.1	400-50	3	6,6	1440	66,1	55	300	177
DF1000F3-CAA2U-4T3	1000.4.2	400-50	3	6,6	1440	67	55	300	177
DF1000F3-CAA3U-4T4	1000.4.3	400-50	4	8,4	1440	67,7	55	300	188
DF1000F3-CAA4U-4T4	1000.4.4	400-50	4	8,4	1440	68,5	55	300	188
DF1000F3-CAA5U-4T5,5	1000.4.5	400-50	5,5	11,2	1440	68,4	55	300	205
DF1000F3-CAA6U-4T7,5	1000.4.6	400-50	7,5	15,4	1440	71,7	55	300	216
DF1000F3-CAA7U-4T11	1000.4.7	400-50	11	21,3	1440	73,4	55	300	281
DF1000F3-CAA8U-4T5,5	1000.4.8	400-50	5,5	11,2	1440	67,8	55	300	207
DF1000F3-CAA9U-4T7,5	1000.4.9	400-50	7,5	15,4	1440	69,3	55	300	218
DF1000F3-CAA10U-4T5,5	1000.4.10	400-50	5,5	11,2	1440	70,9	55	300	209
DF1000F3-CAA11U-4T7,5	1000.4.11	400-50	7,5	15,4	1440	74	55	300	220
DF1000F3-CAA12U-4T11	1000.4.12	400-50	11	21,3	1440	72	55	300	281
DF1000F3-CAA13U-4T11	1000.4.13	400-50	11	21,3	1440	72,4	55	300	281
DF1000F3-CAA14U-4T15	1000.4.14	400-50	15	29,8	1440	73,8	55	300	292
DF1000F3-CAA15U-4T15	1000.4.15	400-50	15	29,8	1440	74,4	55	300	292
DF1000F3-CAA16U-4T7,5	1000.4.16	400-50	7,5	15,4	1440	71,7	55	300	211
DF1000F3-CAA17U-4T7,5	1000.4.17	400-50	7,5	15,4	1440	71,3	55	300	211
DF1000F3-CAA18U-4T11	1000.4.18	400-50	11	21,3	1440	71,3	55	300	271
DF1000F3-CAA19U-4T11	1000.4.19	400-50	11	21,3	1440	72	55	300	271
DF1000F3-CAA20U-4T11	1000.4.20	400-50	11	21,3	1440	76,5	55	300	281
DF1000F3-CAA21U-4T11	1000.4.21	400-50	11	21,3	1440	76,5	55	300	281
DF1000F3-CAA22U-4T15	1000.4.22	400-50	15	29,8	1440	75,5	55	300	292
DF1000F3-CAA23U-4T15	1000.4.23	400-50	15	29,8	1440	74,4	55	300	292
DF1000F3-CAA24U-4T22	1000.4.24	400-50	22	42,5	1440	75,5	55	300	340
DF1000F3-CAA25.AU-4T11	1000.4.25.A	400-50	11	21,3	1440	69,3	55	300	286
DF1000F3-CAA25.BU-4T15	1000.4.25.B	400-50	15	29,8	1440	69,3	55	300	297
DF1000F3-CAA26U-4T15	1000.4.26	400-50	15	29,8	1440	71	55	300	297
DF1000F3-CAA27U-4T22	1000.4.27	400-50	22	42,5	1440	72,4	55	300	345
DF1000F3-CAA28U-4T30	1000.4.28	400-50	30	55	1440	75,1	55	300	384
DF1000F3-CAA29U-4T22	1000.4.29	400-50	22	42,5	1440	73,5	55	300	345
DF1000F3-CAA30U-4T30	1000.4.30	400-50	30	55	1440	73,8	55	300	381
DF1000F3-CAA31U-4T7,5	1000.4.31	400-50	7,5	15,4	1440	74,8	55	300	210

MODEL	MODEL NUMBER	Voltage Frequency	Motor Power	Current	Rotation Speed	Sound Pressure	Protection Class	Working Range	Mass
		V-Hz	kW	A	RPM	Lp(A) dB at 3m	IP	°C	~ Kg
DF1000F3-CAA32U-4T11	1000.4.32	400-50	11	21,3	1440	71,9	55	300	271
DF1000F3-CAA33U-4T15	1000.4.33	400-50	15	29,8	1440	71,4	55	300	282
DF1000F3-CAA34U-4T22	1000.4.34	400-50	22	42,5	1440	78,5	55	300	340
DF1000F3-CAA35U-4T22	1000.4.35	400-50	22	42,5	1440	78,5	55	300	340
DF1000F3-CAA36U-4T30	1000.4.36	400-50	30	55	1440	77,5	55	300	376
DF1000F3-CAA37U-4T37	1000.4.37	400-50	37	67	1440	76,5	55	300	463
DF1120F3-CAA1U-4T5,5	1120.4.1	400-50	5,5	11,2	1440	71,5	55	300	201
DF1120F3-CAA2U-4T7,5	1120.4.2	400-50	7,5	15,4	1440	72,1	55	300	212
DF1120F3-CAA3U-4T11	1120.4.3	400-50	11	21,3	1440	73,6	55	300	296
DF1120F3-CAA4U-4T11	1120.4.4	400-50	11	21,3	1440	73,8	55	300	292
DF1120F3-CAA5U-4T15	1120.4.5	400-50	15	29,8	1440	75,1	55	300	307
DF1120F3-CAA6U-4T18,5	1120.4.6	400-50	18,5	34,5	1440	76,5	55	300	346
DF1120F3-CAA7U-4T7,5	1120.4.7	400-50	7,5	15,4	1440	73,1	55	300	216
DF1120F3-CAA8U-4T11	1120.4.8	400-50	11	21,3	1440	76,5	55	300	296
DF1120F3-CAA9U-4T11	1120.4.9	400-50	11	21,3	1440	75,5	55	300	296
DF1120F3-CAA10U-4T15	1120.4.10	400-50	15	29,8	1440	74,3	55	300	307
DF1120F3-CAA11U-4T15	1120.4.11	400-50	15	29,8	1440	73,8	55	300	307
DF1120F3-CAA12U-4T18,5	1120.4.12	400-50	18,5	34,5	1440	75,5	55	300	346
DF1120F3-CAA13U-4T22	1120.4.13	400-50	22	42,5	1440	76,5	55	300	356
DF1120F3-CAA14U-4T22	1120.4.14	400-50	22	42,5	1440	77,5	55	300	356
DF1120F3-CAA15U-4T22	1120.4.15	400-50	22	42,5	1440	76,5	55	300	356
DF1120F3-CAA16U-4T11	1120.4.16	400-50	11	21,3	1440	78,5	55	300	296
DF1120F3-CAA17U-4T15	1120.4.17	400-50	15	29,8	1440	78,5	55	300	307
DF1120F3-CAA18U-4T15	1120.4.18	400-50	15	29,8	1440	78,5	55	300	307
DF1120F3-CAA19U-4T22	1120.4.19	400-50	22	42,5	1440	76,5	55	300	356
DF1120F3-CAA20U-4T30	1120.4.20	400-50	30	55	1440	79,5	55	300	408
DF1120F3-CAA21U-4T5,5	1120.4.21	400-50	5,5	11,2	1440	79,5	55	300	196
DF1120F3-CAA22U-4T7,5	1120.4.22	400-50	7,5	15,4	1440	79,5	55	300	207
DF1120F3-CAA23U-4T11	1120.4.23	400-50	11	21,3	1440	75,1	55	300	287
DF1120F3-CAA24U-4T15	1120.4.24	400-50	15	29,8	1440	74,6	55	300	298
DF1120F3-CAA25U-4T18,5	1120.4.25	400-50	18,5	34,5	1440	73,6	55	300	337
DF1120F3-CAA26U-4T11	1120.4.26	400-50	11	21,3	1440	79,5	55	300	301
DF1120F3-CAA27U-4T15	1120.4.27	400-50	15	29,8	1440	79,5	55	300	312
DF1120F3-CAA28U-4T15	1120.4.28	400-50	15	29,8	1440	78,5	55	300	312
DF1120F3-CAA29U-4T18,5	1120.4.29	400-50	18,5	34,5	1440	77,5	55	300	351
DF1120F3-CAA30U-4T18,5	1120.4.30	400-50	18,5	34,5	1440	77,5	55	300	351
DF1120F3-CAA31U-4T22	1120.4.31	400-50	22	42,5	1440	77,5	55	300	361
DF1120F3-CAA32U-4T30	1120.4.32	400-50	30	55	1440	76,5	55	300	413
DF1120F3-CAA33U-4T37	1120.4.33	400-50	37	67	1440	76,5	55	300	500
DF1120F3-CAA34U-4T22	1120.4.34	400-50	22	42,5	1440	78,5	55	300	371
DF1120F3-CAA35U-4T30	1120.4.35	400-50	30	55	1440	77,5	55	300	408
DF1120F3-CAA36U-4T15	1120.4.36	400-50	15	29,8	1440	80,5	55	300	318
DF1120F3-CAA37U-4T22	1120.4.37	400-50	22	42,5	1440	77,5	55	300	367
DF1120F3-CAA38U-4T45	1120.4.38	400-50	45	80	1440	77,5	55	300	552
DF1120F3-CAA39U-4T22	1120.4.39	400-50	22	42,5	1440	73,1	55	300	351
DF1120F3-CAA40U-4T30	1120.4.40	400-50	30	55	1440	74,1	55	300	403

MODEL	MODEL NUMBER	Voltage Frequency	Motor Power	Current	Rotation Speed	Sound Pressure	Protection Class	Working Range	Mass
		V-Hz	kW	A	RPM	Lp(A) dB at 3m	IP	°C	~ Kg
DF1250F3-CAA1U-4T11	1250.4.1	400-50	11	21,3	1440	79,5	55	300	293
DF1250F3-CAA2U-4T15	1250.4.2	400-50	15	29,8	1440	78,5	55	300	304
DF1250F3-CAA3U-4T18,5	1250.4.3	400-50	18,5	34,5	1440	78,5	55	300	342
DF1250F3-CAA4U-4T18,5	1250.4.4	400-50	18,5	34,5	1440	78,5	55	300	342
DF1250F3-CAA5U-4T22	1250.4.5	400-50	22	42,5	1440	78,5	55	300	352
DF1250F3-CAA6U-4T11	1250.4.6	400-50	11	21,3	1440	83,5	55	300	293
DF1250F3-CAA7U-4T18,5	1250.4.7	400-50	18,5	34,5	1440	84,5	55	300	342
DF1250F3-CAA8U-4T22	1250.4.8	400-50	22	42,5	1440	84,5	55	300	352
DF1250F3-CAA9U-4T22	1250.4.9	400-50	22	42,5	1440	84,5	55	300	352
DF1250F3-CAA10U-4T22	1250.4.10	400-50	22	42,5	1440	84,5	55	300	352
DF1250F3-CAA11U-4T30	1250.4.11	400-50	30	55	1440	82,5	55	300	389
DF1250F3-CAA12U-4T30	1250.4.12	400-50	30	55	1440	83,5	55	300	389
DF1250F3-CAA13U-4T30	1250.4.13	400-50	30	55	1440	77,5	55	300	389
DF1250F3-CAA14U-4T30	1250.4.14	400-50	30	55	1440	83,5	55	300	389
DF1250F3-CAA15U-4T30	1250.4.15	400-50	30	55	1440	78,5	55	300	389
DF1250F3-CAA16U-4T30	1250.4.16	400-50	30	55	1440	79,5	55	300	389
DF1250F3-CAA17U-4T37	1250.4.17	400-50	37	67	1440	79,5	55	300	475
DF1250F3-CAA18U-4T37	1250.4.18	400-50	37	67	1440	79,5	55	300	475
DF1250F3-CAA19U-4T37	1250.4.19	400-50	37	67	1440	79,5	55	300	475
DF1250F3-CAA20U-4T45	1250.4.20	400-50	45	80	1440	79,5	55	300	521
DF1250F3-CAA21U-4T45	1250.4.21	400-50	45	80	1440	79,5	55	300	521
DF1250F3-CAA22U-4T45	1250.4.22	400-50	45	80	1440	79,5	55	300	521
DF1250F3-CAA23U-4T45	1250.4.23	400-50	45	80	1440	37,5	55	300	521
DF1250F3-CAA24U-4T45	1250.4.24	400-50	45	80	1440	80,5	55	300	521
DF1250F3-CAA25U-4T55	1250.4.25	400-50	55	96,8	1440	81,5	55	300	605
DF1250F3-CAA26U-4T55	1250.4.26	400-50	55	96,8	1440	81,5	55	300	605
DF1250F3-CAA27U-4T55	1250.4.27	400-50	55	96,8	1440	81,5	55	300	605
DF1250F3-CAA28U-4T22	1250.4.28	400-50	22	42,5	1440	84,5	55	300	352
DF1250F3-CAA29.AU-4T22	1250.4.29.A	400-50	22	42,5	1440	84,5	55	300	352
DF1250F3-CAA29.BU-4T30	1250.4.29.B	400-50	30	55	1440	84,5	55	300	389
DF1250F3-CAA30U-4T30	1250.4.30	400-50	30	55	1440	82,5	55	300	389
DF1250F3-CAA31U-4T30	1250.4.31	400-50	30	55	1440	82,5	55	300	389
DF1250F3-CAA32U-4T45	1250.4.32	400-50	45	80	1440	80,5	55	300	521
DF1250F3-CAA33U-4T55	1250.4.33	400-50	55	96,8	1440	79,5	55	300	605
DF1250F3-CAA34U-4T55	1250.4.34	400-50	55	96,8	1440	79,5	55	300	605
DF1250F3-CAA35U-4T55	1250.4.35	400-50	55	96,8	1440	79,5	55	300	605
DF1250F3-CAA36U-4T11	1250.4.36	400-50	11	21,3	1440	72,5	55	300	298
DF1250F3-CAA37U-4T18,5	1250.4.37	400-50	18,5	34,5	1440	74,8	55	300	347
DF1250F3-CAA38U-4T22	1250.4.38	400-50	22	42,5	1440	75,4	55	300	357
DF1250F3-CAA39U-4T30	1250.4.39	400-50	30	55	1440	80,5	55	300	394
DF1250F3-CAA40U-4T30	1250.4.40	400-50	30	55	1440	81,5	55	300	394
DF1250F3-CAA41U-4T37	1250.4.41	400-50	37	67	1440	78,5	55	300	480
DF1250F3-CAA42U-4T37	1250.4.42	400-50	37	67	1440	79,5	55	300	478

AXIAL UNIDIRECTIONAL JET FANS

DRAGONFLY



- Body is electrostatic powder painted for resistance to corrosion, optionally, the body can manufacture from hot dip galvanized sheet
- Unique silencer design
- Heat treated high temperature resistant aluminum impeller
- Double speed three phase H class insulated F300 motor
- With resistance to 300 C for 2 hours, CE certified according to EN 12101-3 (No2184-CPR-0033)

TECHNICAL PARAMETERS

MODEL	SPEED	VOLUME FLOW RATE	THRUST	VOLTAGE	POWER
	RPM	m ³ /h	N	V	KW
DF315F3-JAU	2820/1400	5750/2875	39/10	400	0,8/0,2
DF355F3-JAU	2810/1390	8050/4025	60/15	400	1,1/0,25
DF400F3-JAU	2900/1435	10800/5400	85/21	400	1,5/0,37
DF450F3-JAU	2845/1420	14300/7150	120/30	400	2,2/0,5

PRODUCT DIMENSIONS

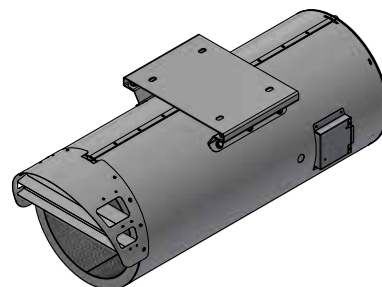
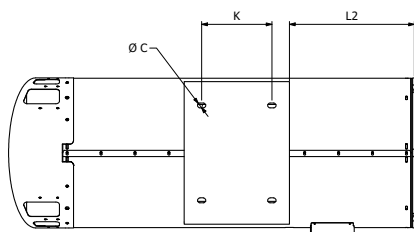
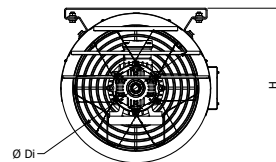
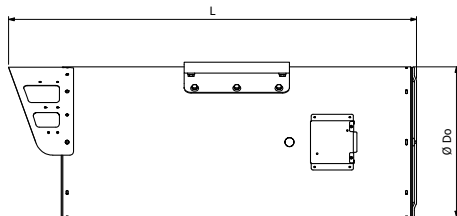

MODEL	Di	Do	H	L	L2	E	K	ØC
DF315F3-JAU	315	385	400	1400	350	240	200	14
DF355F3-JAU	355	425	440	1400	350	270	200	14
DF400F3-JAU	400	470	485	1550	515	320	250	14
DF450F3-JAU	450	520	535	1550	530	350	250	14

AXIAL REVERSIBLE JET FANS



- Body is electrostatic powder painted for resistance to corrosion, optionally, the body can manufacture from hot dip galvanized sheet
- Unique silencer design
- The fan can work reversible
- Heat treated high temperature resistant aluminum impeller
- Double speed three phase H class insulated F300 motor
- With resistance to 300 C for 2 hours, CE certified according to EN 12101-3 (No2184-CPR-0033)

TECHNICAL PARAMETERS

MODEL	SPEED	VOLUME FLOW RATE	THRUST	VOLTAGE	POWER
	RPM	m ³ /h	N	V	KW
DF315F3-JAR	2820/1400	4700/2350	22 / 6	400	0,8/0,2
DF355F3-JAR	2810/1390	6600/3300	32 / 8	400	1,1/0,25
DF400F3-JAR	2900/1435	8800/4400	60 / 15	400	1,5/0,37
DF450F3-JAR	2845/1420	11700/5850	84 / 21	400	2,2/0,5

PRODUCT DIMENSIONS

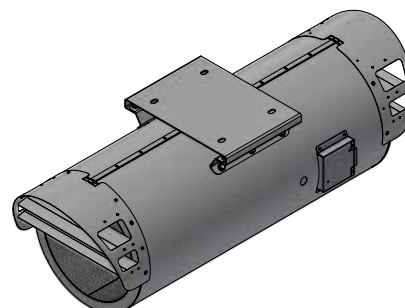
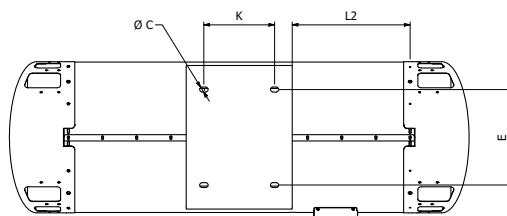
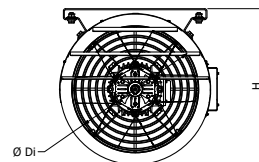
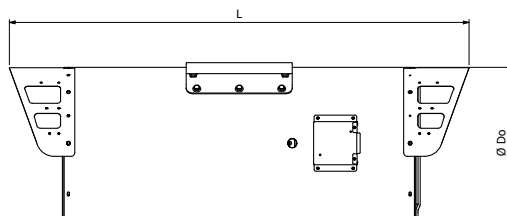

MODEL	Di	Do	H	L	L2	E	K	øC
DF315F3-JAR	315	385	400	1550	350	240	200	14
DF355F3-JAR	355	425	440	1550	350	270	200	14
DF400F3-JAR	400	470	485	1700	515	320	250	14
DF450F3-JAR	450	520	535	1700	530	350	250	14

RADIAL JET FANS



- Body is electrostatic powder painted for resistance to corrosion, optionally, the body can manufacture from hot dip galvanized sheet
- Dynamically balanced galvanized propeller in accordance with ISO 1940
- Double speed three phase H class insulated smoke evacuation motor
- Suction side with protective wire and inlet cone
- Resistant to 300 degrees for 2 hours according to EN 12101-3 (EEA-2000-0123)

TECHNICAL PARAMETERS

MODEL	SPEED	VOLUME FLOW RATE	THRUST	VOLTAGE	POWER
	RPM	m ³ /h	N	V	KW
DF60NF3-JR	1430/705	7000 / 3500	60/15	400	1,2/0,3

PRODUCT DIMENSIONS

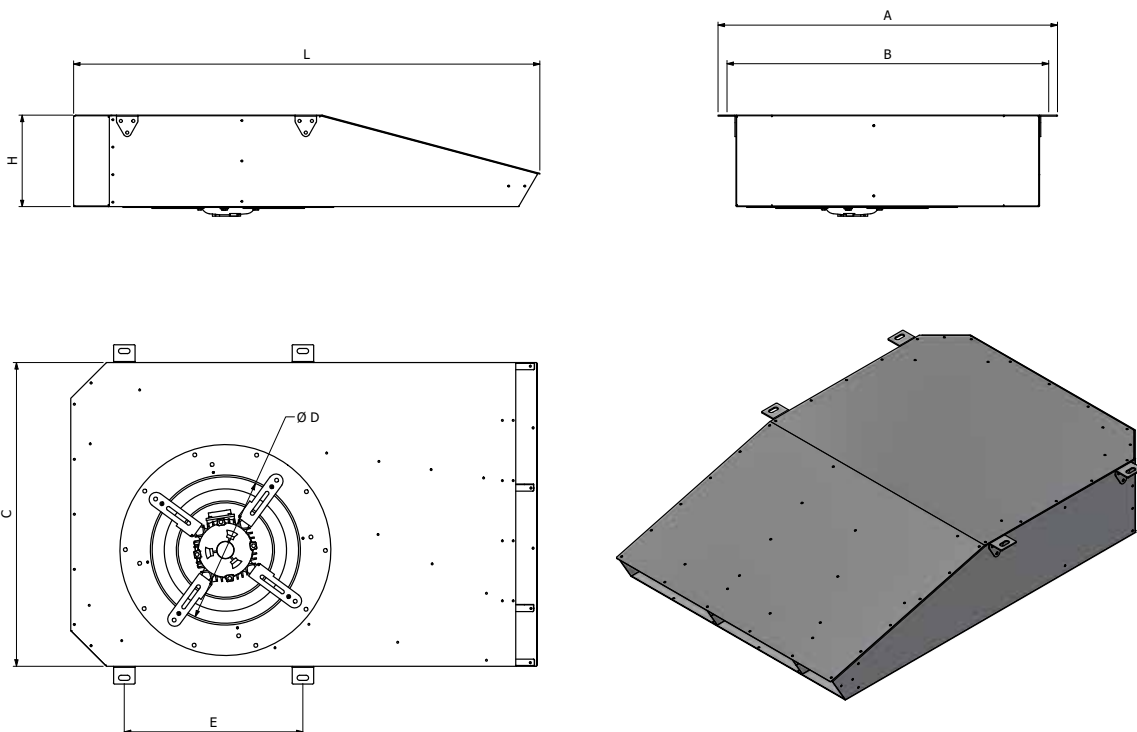

MODEL	A	B	C	ØD	E	H	L
DF60NF3-JR	950	915	850	500	500	254	1300

JET FAN THROW DISTANCE

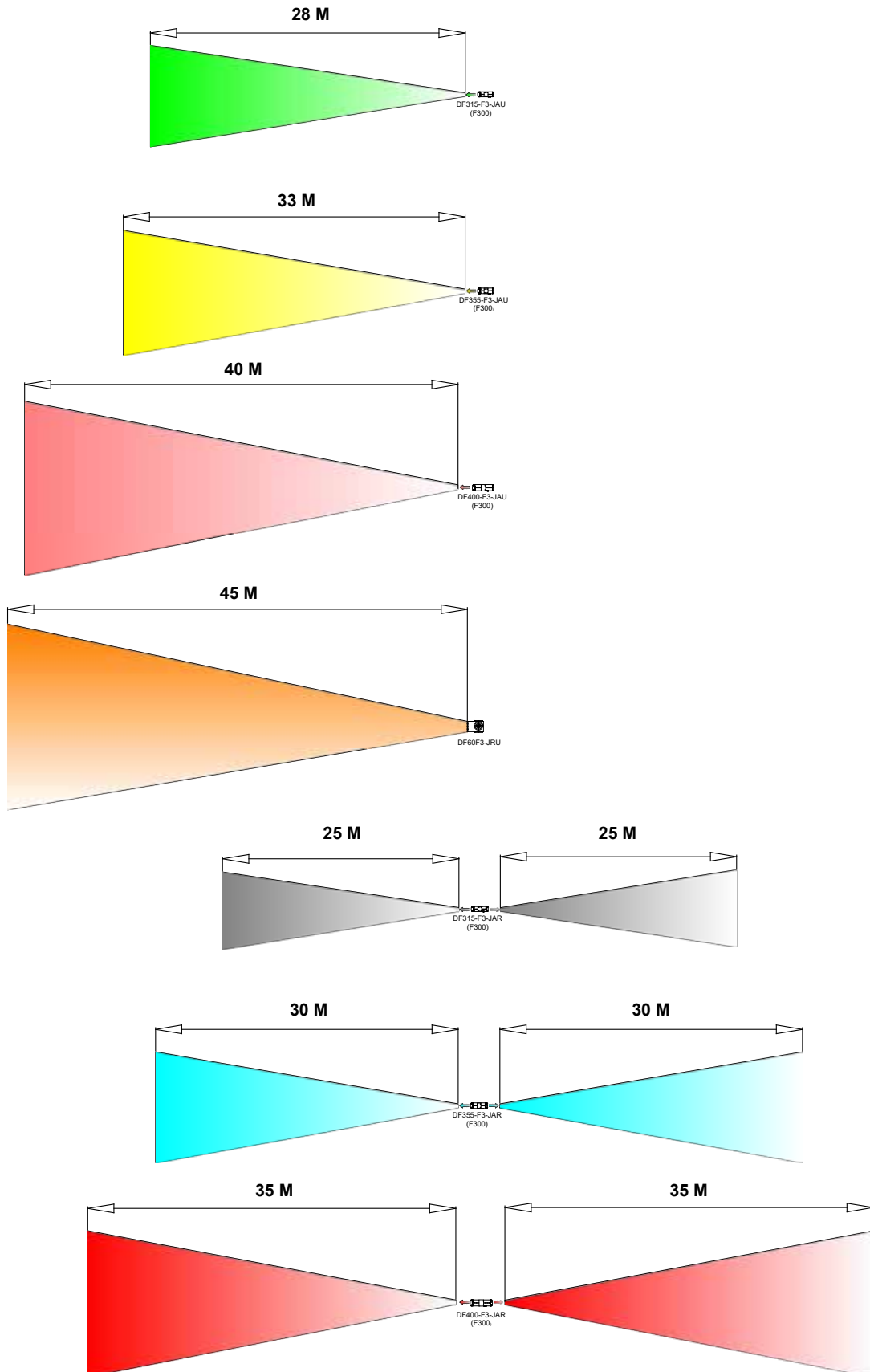

NOVVES

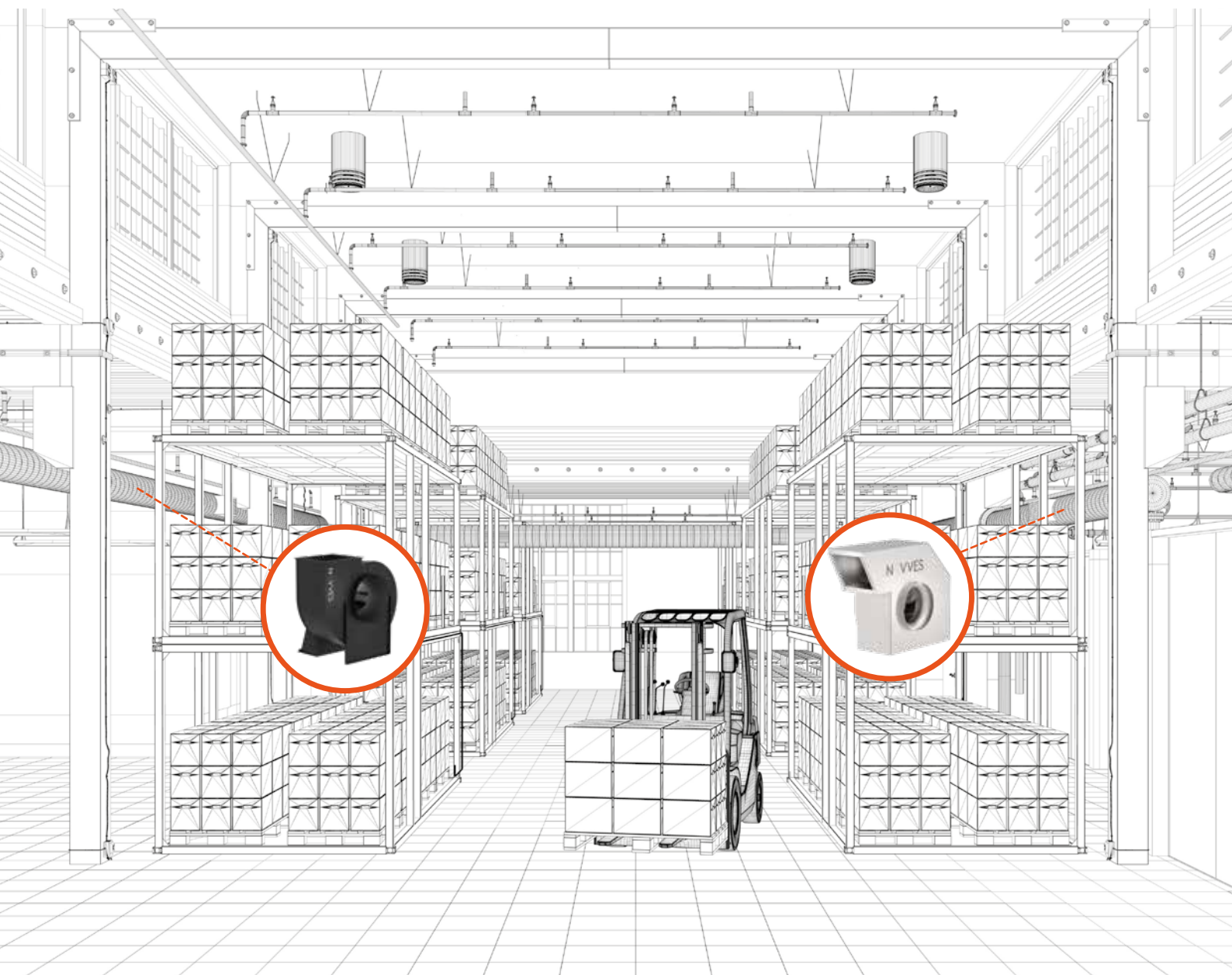

Nautilus
Industrial Fan

NAUTILUS LPF SERIES

General

The fans in this series not only save energy but also offer high performance with their backward curved blade structure and direct coupled motor assembly. It can be used for evacuation of air containing dust, sawdust, oil and similar particles and in projects where fresh air is needed. Quietly working fans have the feature of changing direction on the body and the flow direction can be changed in desired direction.

Body

The body is manufactured with electrostatic powder paint for corrosion resistance. It provides convenient and easy installation with its compact design.

Impeller

The fan blades are aerodynamically curved and provide regular flow. Fans consist of backward curved and sparsely arranged blades.

Motor

All models are equipped with a three-phase asynchronous motor. It can be used in the exhaust of air up to 50°C.

IP Class

All products of this series have IP 55 class protection and F class insulation.

Control

It can be operated directly with the help of the MCC board. Speed adjustment is made by frequency inverter.

Fan Code

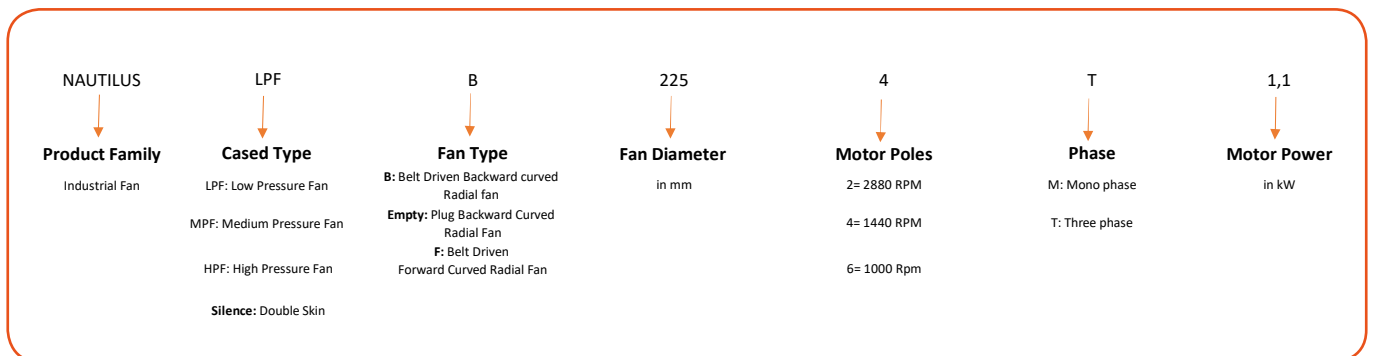

NAUTILUS SILENCE SERIES

General

NAUTILUS SILENCE series fans offer high performance as well as providing energy savings with their backward curved blade structure and direct coupled motor assembly. These fans, which have a very wide usage area, increase the air quality in areas where fresh air and exhaust are needed. Stone wool, which provides sound insulation between the double-walled body, is used in the fans, which are easily mounted to ventilation systems and operate very quietly.

Body

The body is manufactured with electrostatic powder paint for corrosion resistance. It provides regular flow with its snail design. It provides convenient and easy installation with its compact design.

Impeller

The fan blades are backward curved and sparsely designed, aerodynamically curved and provide regular flow.

Motor

All models are equipped with an external rotor motor with a closed structure and are suitable for operation up to a maximum of 40°C.

IP Class

All products of this series have IP 44 protection and F class insulation.

Control

Fans with single-phase motors can be operated with the on/off switch, while fans with three-phase motors can be operated directly with the help of the MCC panel. The speed adjustment of the models with single-phase motors is made by the speed switch, and the speed of the models with three-phase motors is made by the frequency inverter.

LOW PRESSURE CENTRIFUGAL FANS



- Body is electrostatic powder painted for resistance to corrosion, optionally, the body can manufacture from hot dip galvanized sheet
- Backward curved impeller
- Direct coupled
- The suction and blowing side can be set
- Rotational speed can be set with frequency inverter

NAUTILUS LPF - SYSTEM CURVE

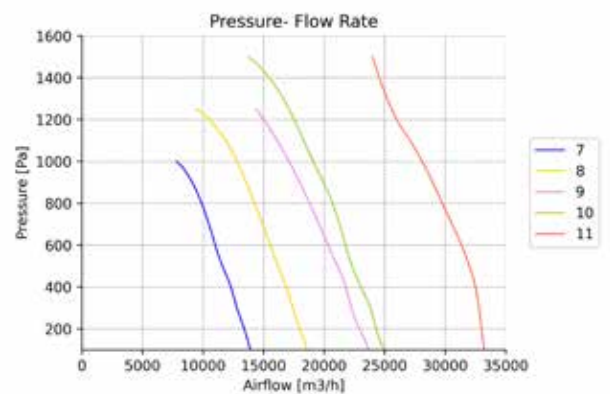
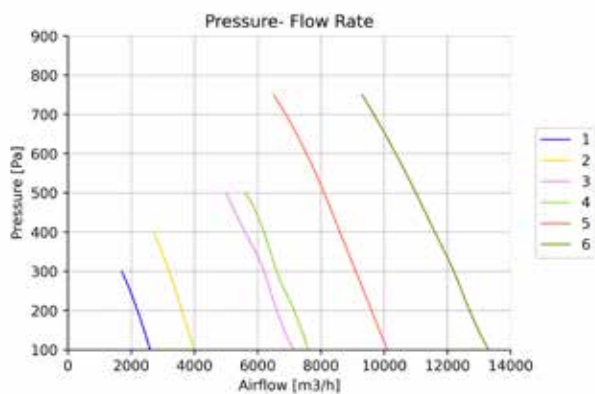

TECHNICAL PARAMETERS

MODEL	MODEL NUMBER	Voltage Frequency	Motor Power	Current	Rotation Speed	Sound Pressure	Protection Class	Working Range	Mass
		V-Hz	kW	A	RPM	Lp(A) dB at 3m	IP	°C	Kg
NAUTILUS LPF 315 4T0,37	1	400-50	0,37	1,2	1450	52	55	-20/+50	63
NAUTILUS LPF 355 4T0,75	2	400-50	0,75	2,1	1450	63	55	-20/+50	57
NAUTILUS LPF 400 4T1,1	3	400-50	1,1	2,7	1450	64	55	-20/+50	69
NAUTILUS LPF 400 4T1,5	4	400-50	1,5	3,6	1450	67	55	-20/+50	70
NAUTILUS LPF 450 4T2,2	5	400-50	2,2	5,3	1450	70	55	-20/+50	107
NAUTILUS LPF 500 4T3	6	400-50	3	6,6	1450	71	55	-20/+50	140
NAUTILUS LPF 500 4T4	7	400-50	4	8,7	1450	73	55	-20/+50	193
NAUTILUS LPF 560 4T5,5	8	400-50	5,5	11,8	1450	75	55	-20/+50	193
NAUTILUS LPF 630 4T7,5	9	400-50	7,5	15,8	1450	77	55	-20/+50	215
NAUTILUS LPF 630 4T11	10	400-50	11	22,5	1450	79	55	-20/+50	218
NAUTILUS LPF 710 4T15	11	400-50	15	30,5	1450	81	55	-20/+50	345

PRODUCT DIMENSIONS

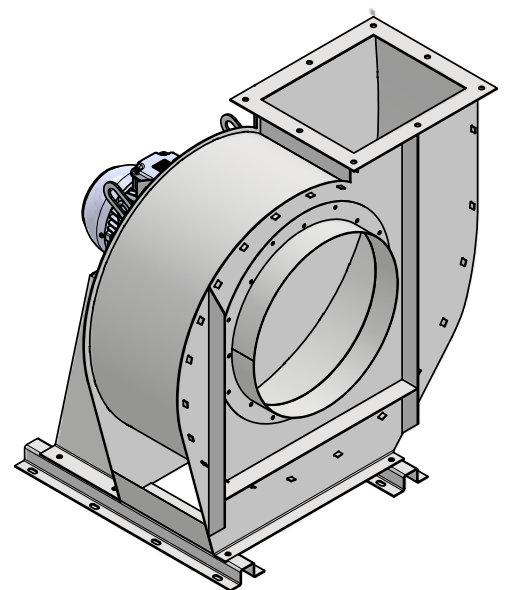
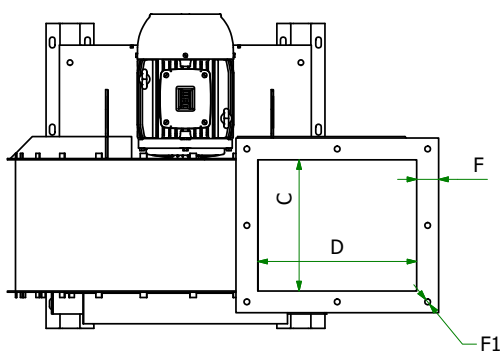
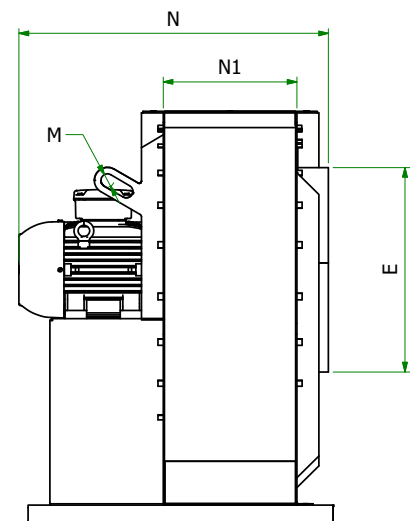
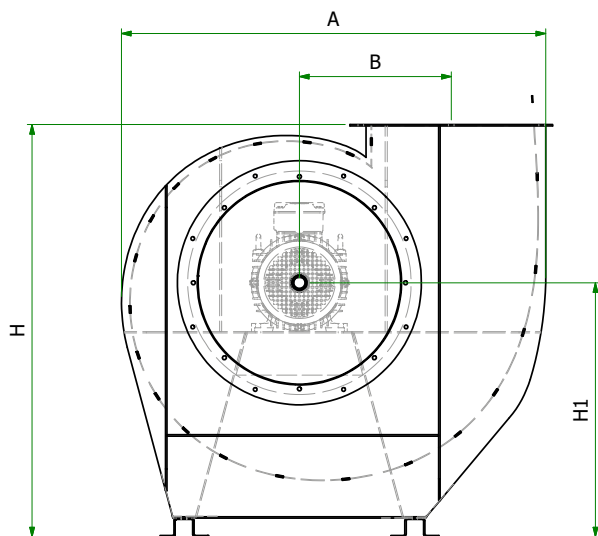

MODEL	A	B	C	D	E	F	F1	H	H1	M	N	N1
NAUTILUS LPF 315 4T0,37	771	208	301	412	314	40	Ø13x14	846	467	Ø41	745	301
NAUTILUS LPF 355 4T0,75	850	231	334	457	354	40	Ø13x14	927	504	Ø41	798	334
NAUTILUS LPF 400 4T1,1	940	254	370	510	399	40	Ø13x14	1023	557	Ø41	934	370
NAUTILUS LPF 400 4T1,5	940	254	370	510	399	40	Ø13x14	1023	557	Ø41	934	370
NAUTILUS LPF 450 4T2,2	1024	281	406	559	449	40	Ø13x14	1127	617	Ø41	934	406
NAUTILUS LPF 500 4T3	1127	317	449	618	499	40	Ø13x14	1231	667	Ø41	962	449
NAUTILUS LPF 500 4T4	1127	317	449	618	499	40	Ø13x14	1231	667	Ø41	962	449
NAUTILUS LPF 560 4T5,5	1241	343	505	683	559	40	Ø13x18	1349	727	Ø41	980	505
NAUTILUS LPF 630 4T7,5	1382	380	550	758	629	50	Ø13x18	1052	817	Ø41	1112	550
NAUTILUS LPF 630 4T11	1382	380	550	758	629	50	Ø13x18	1052	817	Ø41	1112	550
NAUTILUS LPF 710 4T15	1516	419	606	837	709	50	Ø15x20	1627	867	Ø41	1306	606

DOUBLE SKIN ACOUSTIC CENTRIFUGAL FANS



- The body is Electrostatic powder painted for resistance to corrosion
- Backward curved impeller
- Direct coupled
- Extremely Low noise level
- Rotational speed can be set with frequency inverter

NAUTILUS - SYSTEM CURVE

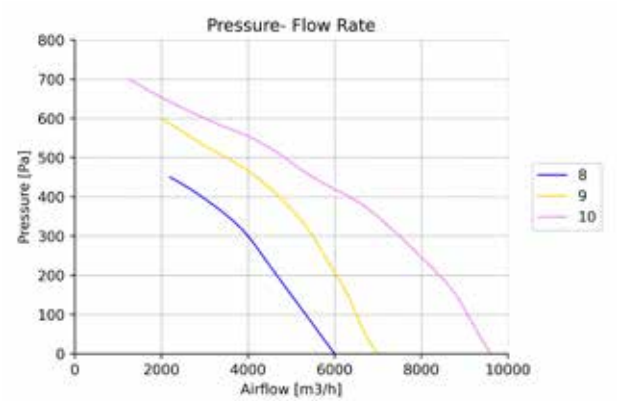
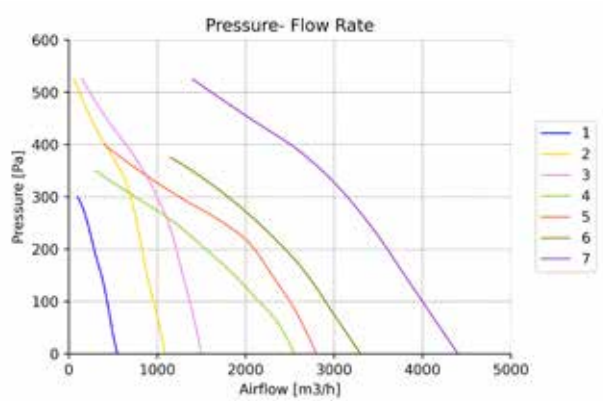

TECHNICAL PARAMETERS

MODEL	MODEL NUMBER	Voltage	Motor	Current	Rotation	Sound	Protection	Working	Mass
		Frequency	Power		Speed	Pressure	Class	Range	
		V-Hz	W	A	RPM	Lp(A) dB at 3m	IP	°C	Kg
NAUTILUS SILENCE 190 2M0,06	1	230-50	60	0,35	2700	45	44	-30/60	11
NAUTILUS SILENCE 225 2M0,135	2	230-50	135	0,6	2600	50	44	-30/60	15
NAUTILUS SILENCE 250 2M0,23	3	230-50	230	1,05	2700	52	44	-30/60	17
NAUTILUS SILENCE 355 2M0,21	4	230-50	210	1	2450	43	54	-30/60	28
NAUTILUS SILENCE 400 2M0,26	5	230-50	260	1,5	1400	48	54	-30/60	38
NAUTILUS SILENCE 355 2M0,4	6	230-50	400	2,6	1400	52	54	-30/60	41
NAUTILUS SILENCE 400 2T0,51	7	230-50	510	1,5	1380	49	54	-30/60	52
NAUTILUS SILENCE 450 4T0,75	8	400-50	800	3,5	1350	59	54	-30/60	58
NAUTILUS SILENCE 450 4T1,1	9	400-50	1100	2,5	1400	62	54	-30/60	71
NAUTILUS SILENCE 500 4T1,5	10	400-50	1500	2,6	1400	60	54	-30/60	79

PRODUCT DIMENSIONS

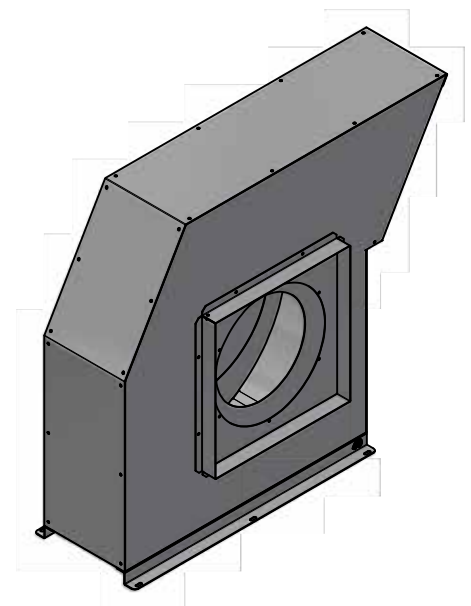
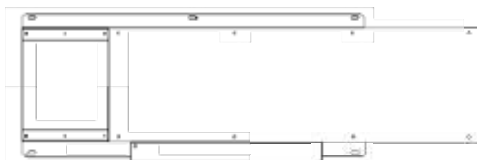
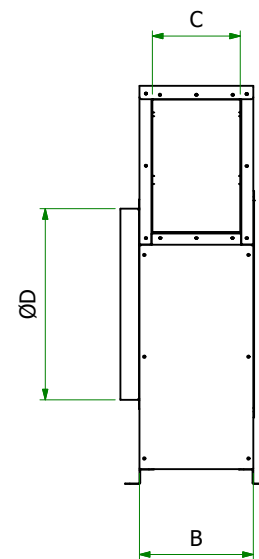
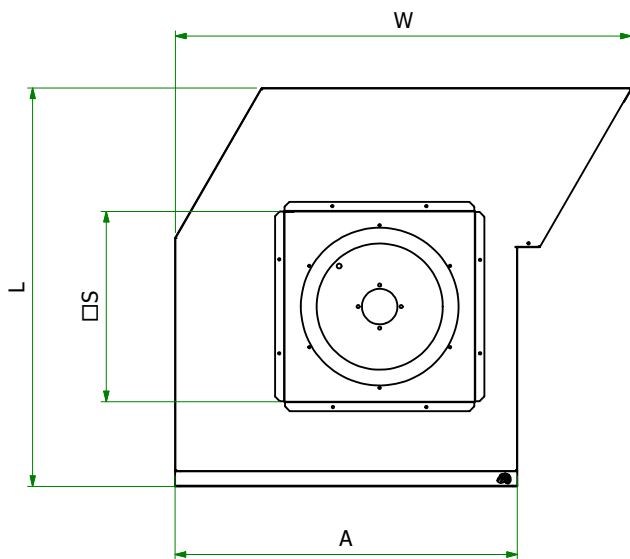

MODEL	L	W	A	B	C	ØD	□S
NAUTILUS SILENCE 190 2M0,06	435	510	365	135	81	180	200
NAUTILUS SILENCE 225 2M0,135	501	605	425	155	105	200	237
NAUTILUS SILENCE 250 2M0,23	550	630	470	160	100	260	260
NAUTILUS SILENCE 355 2M0,21	750	910	640	230	170	365	365
NAUTILUS SILENCE 400 2M0,26	835	955	715	240	185	400	400
NAUTILUS SILENCE 355 2M0,4	750	950	650	290	240	360	360
NAUTILUS SILENCE 400 2T0,51	790	1000	700	290	240	410	410
NAUTILUS SILENCE 450 4T0,75	880	1230	790	300	250	460	460
NAUTILUS SILENCE 450 4T1,1	880	1230	790	310	260	460	460
NAUTILUS SILENCE 500 4T1,5	1040	1300	900	390	340	510	510

NOVVES

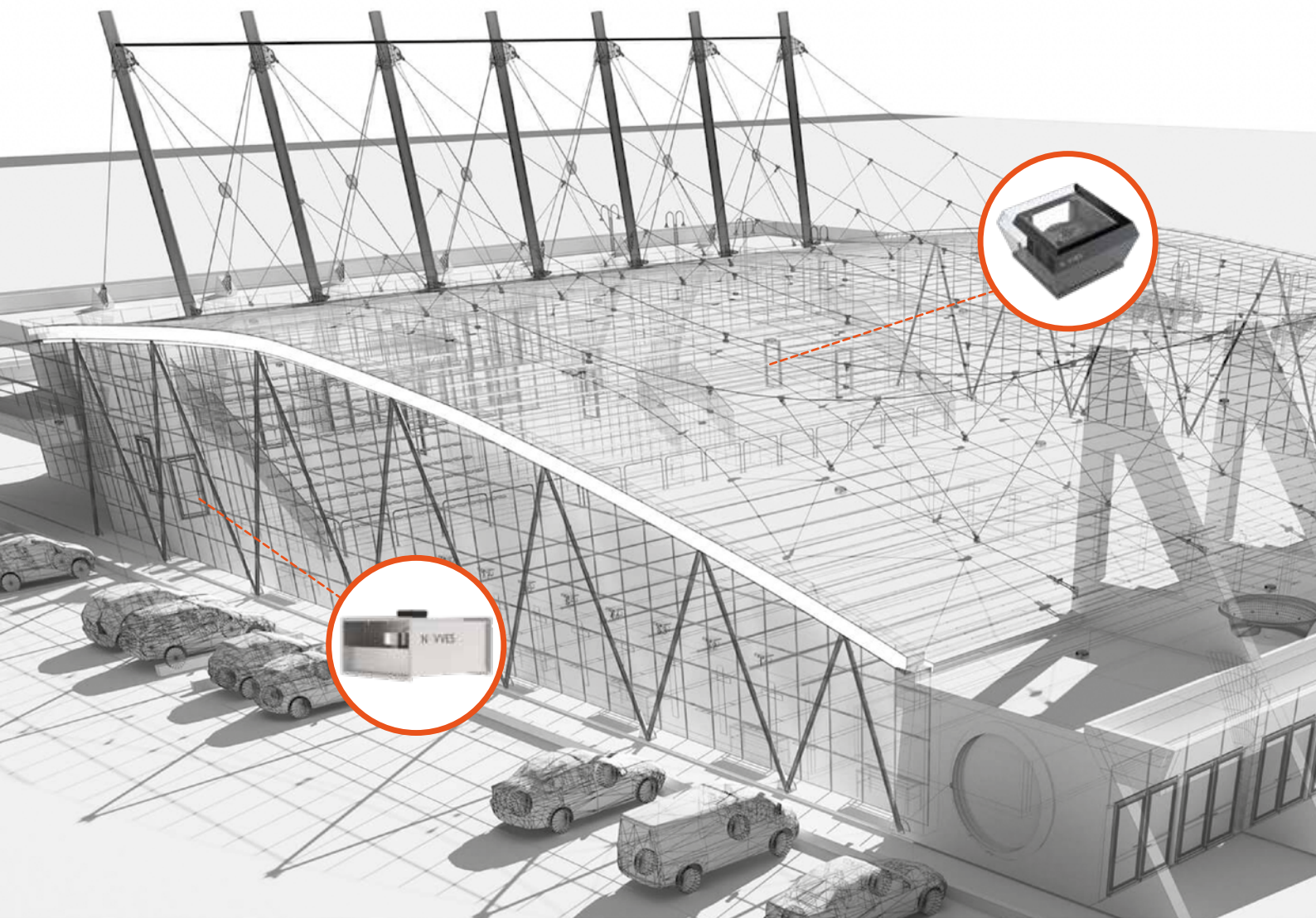

Hummingbird
EC Fan

HUMMINGBIRD SERIES

General

Roof and duct type fans in the Hummingbird series, in which EC Motors are used, provide high performance as well as providing energy savings. It is used to provide air quality and air conditioning control in areas where exhaust and fresh air are required. Blade and motor maintenance is facilitated by the maintenance cover on EC Rectangular duct fans. With the help of a differential pressure sensor with a PI unit, the fans in the series operate automatically (optionally) according to the need.

Body

The body is made of galvanized sheet. Coating options with epoxy paint or electrostatic powder paint are also available. The suction and discharge ports of the EC rectangular duct fan are flanged.

Motor

High efficiency EC single-phase and three-phase external rotor motors are used.

Impeller

The fan blades are backward curved and sparsely designed, aerodynamically curved and provide regular flow.

IP Class

All products of this series have IP 54 class protection and F class insulation.

Fan Code

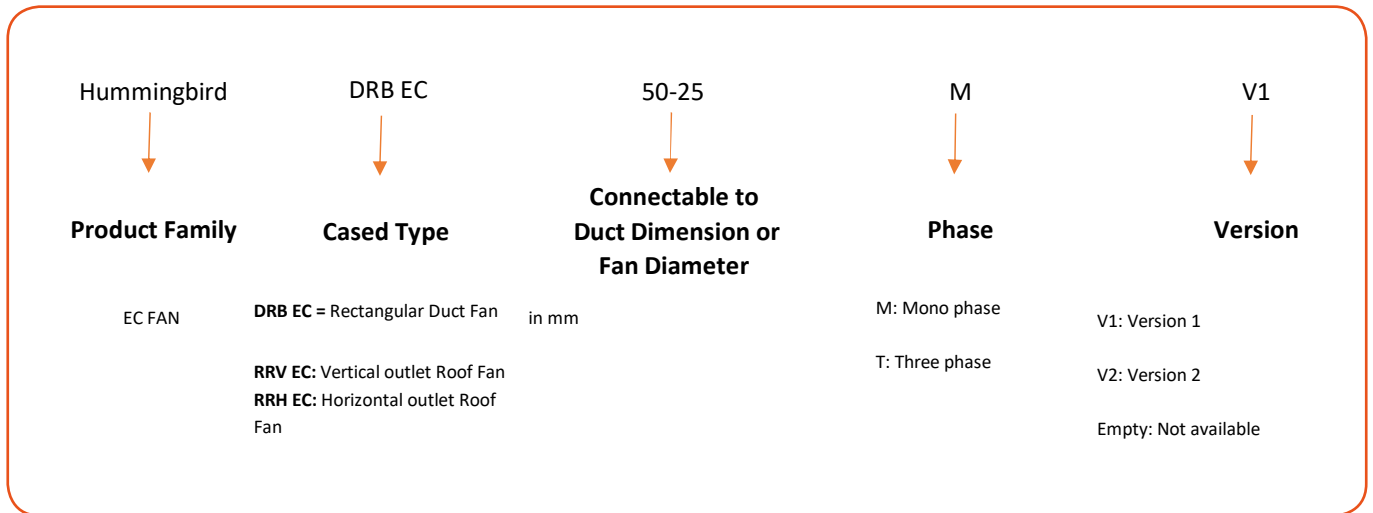

EC VERTICAL ROOF FANS



- Body manufactured from high quality galvanized sheet
- The Fan can be used for fresh air or air exhaust up to 40°C.
- With backward curved impeller
- Rotational speed can be set with speed controller and frequency inverter
- Can be controlled by 0-10 volt control or speed switch.
- It can be operated automatically according to need, with the help of differential pressure sensor with PI unit.
- Maintenance switch is optional

HUMMINGBIRD RRV - SYSTEM CURVE

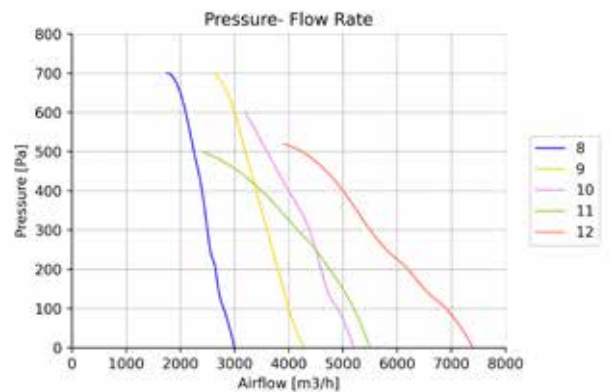
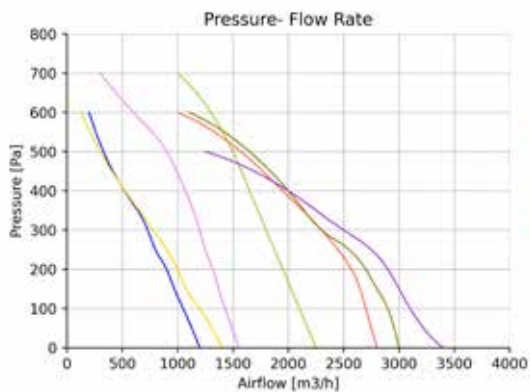

TECHNICAL PARAMETERS

MODEL	MODEL NUMBER	Voltage Frequency	Motor Power	Current	Rotation Speed	Sound Pressure	Protection Class	Working Range	Mass
		V-Hz	W	A	RPM	Lp(A) dB at 3m	IP	°C	Kg
HUMMINGBIRD RRV EC 225M	1	230-50	130	0,87	3000	52	IP54	-20/50	9
HUMMINGBIRD RRV EC 250MV1	2	230-50	270	0,87	2850	51	IP54	-20/50	12
HUMMINGBIRD RRV EC 250MV2	3	230-50	270	1,2	3170	51	IP54	-20/50	13
HUMMINGBIRD RRV EC 280M	4	230-50	395	1,88	2850	52	IP54	-20/50	14
HUMMINGBIRD RRV EC 310M	5	230-50	320	1,45	2200	54	IP54	-20/50	16
HUMMINGBIRD RRV EC 355M	6	230-50	330	1,5	1900	57	IP54	-20/50	26
HUMMINGBIRD RRV EC 400M	7	230-50	270	1,25	1500	56	IP54	-20/50	29
HUMMINGBIRD RRV EC 280T	8	400-50	860	1,22	3000	53	IP54	-20/50	15
HUMMINGBIRD RRV EC 310T	9	400-50	980	1,64	2600	54	IP54	-20/50	18
HUMMINGBIRD RRV EC 355T	10	400-50	990	1,63	2100	55	IP54	-20/50	26
HUMMINGBIRD RRV EC 400T	11	400-50	725	1,22	1550	56	IP54	-20/50	28
HUMMINGBIRD RRV EC 450T	12	400-50	1006	1,67	1450	60	IP54	-20/50	43

PRODUCT DIMENSIONS

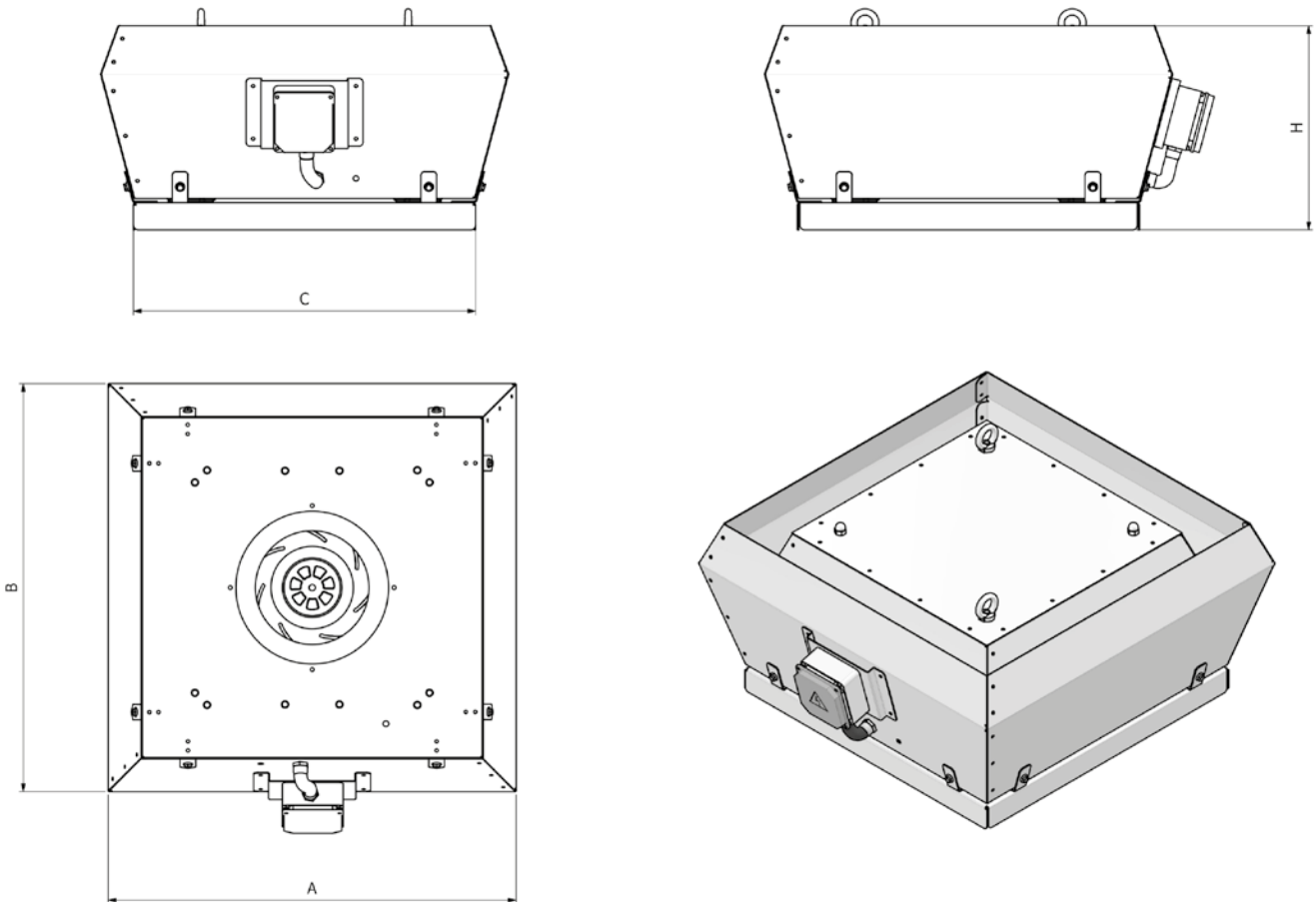

MODEL	A	B	C	H	Ø
HUMMINGBIRD RRV EC 225M	525	525	440	265	225
HUMMINGBIRD RRV EC 250MV1	525	525	440	265	250
HUMMINGBIRD RRV EC 250MV2	525	525	440	265	250
HUMMINGBIRD RRV EC 280M	615	615	500	342	280
HUMMINGBIRD RRV EC 310M	625	625	530	350	310
HUMMINGBIRD RRV EC 355M	635	635	570	350	355
HUMMINGBIRD RRV EC 400M	722	722	610	360	400
HUMMINGBIRD RRV EC 280T	615	615	500	342	280
HUMMINGBIRD RRV EC 310T	625	625	530	350	310
HUMMINGBIRD RRV EC 355T	635	635	570	350	355
HUMMINGBIRD RRV EC 400T	722	722	610	360	400
HUMMINGBIRD RRV EC 450T	850	850	720	500	450

EC RECTUNGULAR DUCT FANS



- Body manufactured from high quality galvanized sheet
- With backward curved impeller
- Suction and discharge side are self-flanged
- Service cover for propeller and motor maintenance
- Suitable for aspiration or ventilation depending on the mounting direction
- It can be operated automatically according to need with the help of differential pressure sensor with PI unit.

HUMMINGBIRD DRB - SYSTEM CURVE

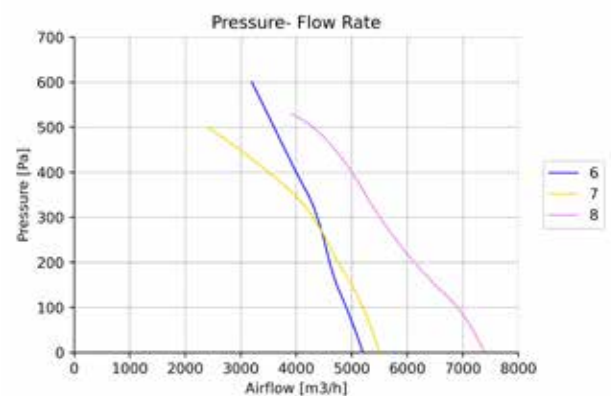
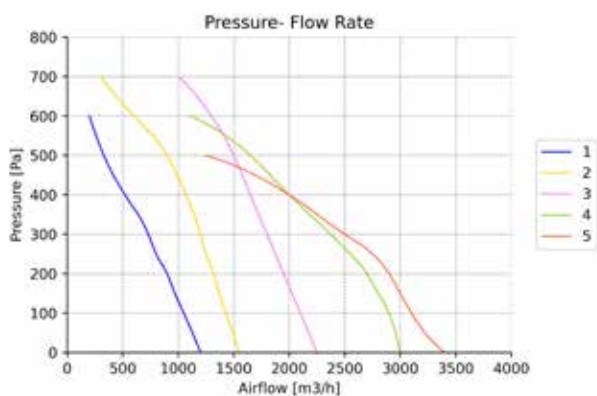

TECHNICAL PARAMETERS

MODEL	MODEL NUMBER	Voltage	Motor	Current	Rotation	Sound	Protection	Working	Mass
		Frequency	Power		Speed	Pressure	Class	Range	
		V-Hz	W	A	RPM	Lp(A) dB at 3m	IP	°C	Kg
HUMMINGBIRD DRB EC 40-20M	1	230-50	130	0,87	3000	59	IP54	-20/50	18
HUMMINGBIRD DRB EC 50-25MV1	2	230-50	270	1,2	3170	61	IP54	-20/50	24
HUMMINGBIRD DRB EC 50-25MV2	3	230-50	395	1,88	2850	68	IP54	-20/50	27
HUMMINGBIRD DRB EC 60-35M	4	230-50	330	1,5	1900	66	IP54	-20/50	50
HUMMINGBIRD DRB EC 70-40M	5	230-50	270	1,25	1500	60	IP54	-20/50	55
HUMMINGBIRD DRB EC 60-35T	6	400-50	990	1,63	2100	64	IP54	-20/50	54
HUMMINGBIRD DRB EC 70-40T	7	400-50	725	1,22	1550	65	IP54	-20/50	60
HUMMINGBIRD DRB EC 80-50T	8	400-50	1006	1,67	1450	68	IP54	-20/50	82

PRODUCT DIMENSIONS

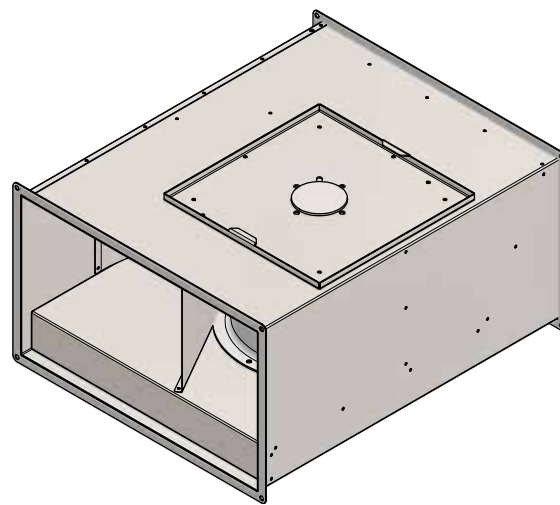
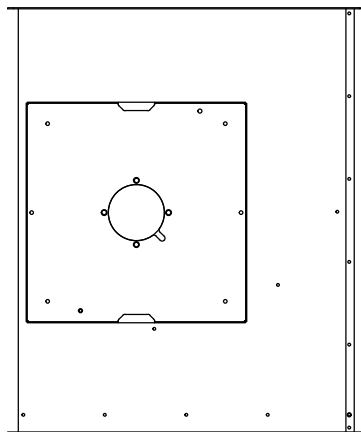
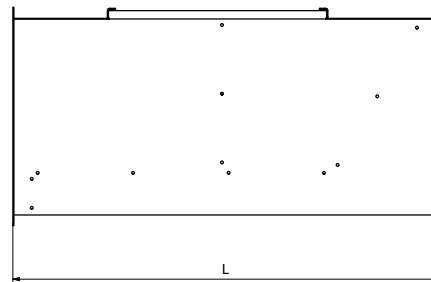
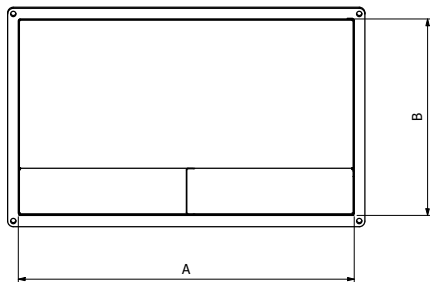

MODEL	A	B	L
HUMMINGBIRD DRB EC 40-20M	400	200	500
HUMMINGBIRD DRB EC 50-25MV1	500	250	500
HUMMINGBIRD DRB EC 50-25MV2	500	250	500
HUMMINGBIRD DRB EC 60-35M	600	350	760
HUMMINGBIRD DRB EC 70-40M	700	400	800
HUMMINGBIRD DRB EC 80-50T	800	500	800

NOVVES

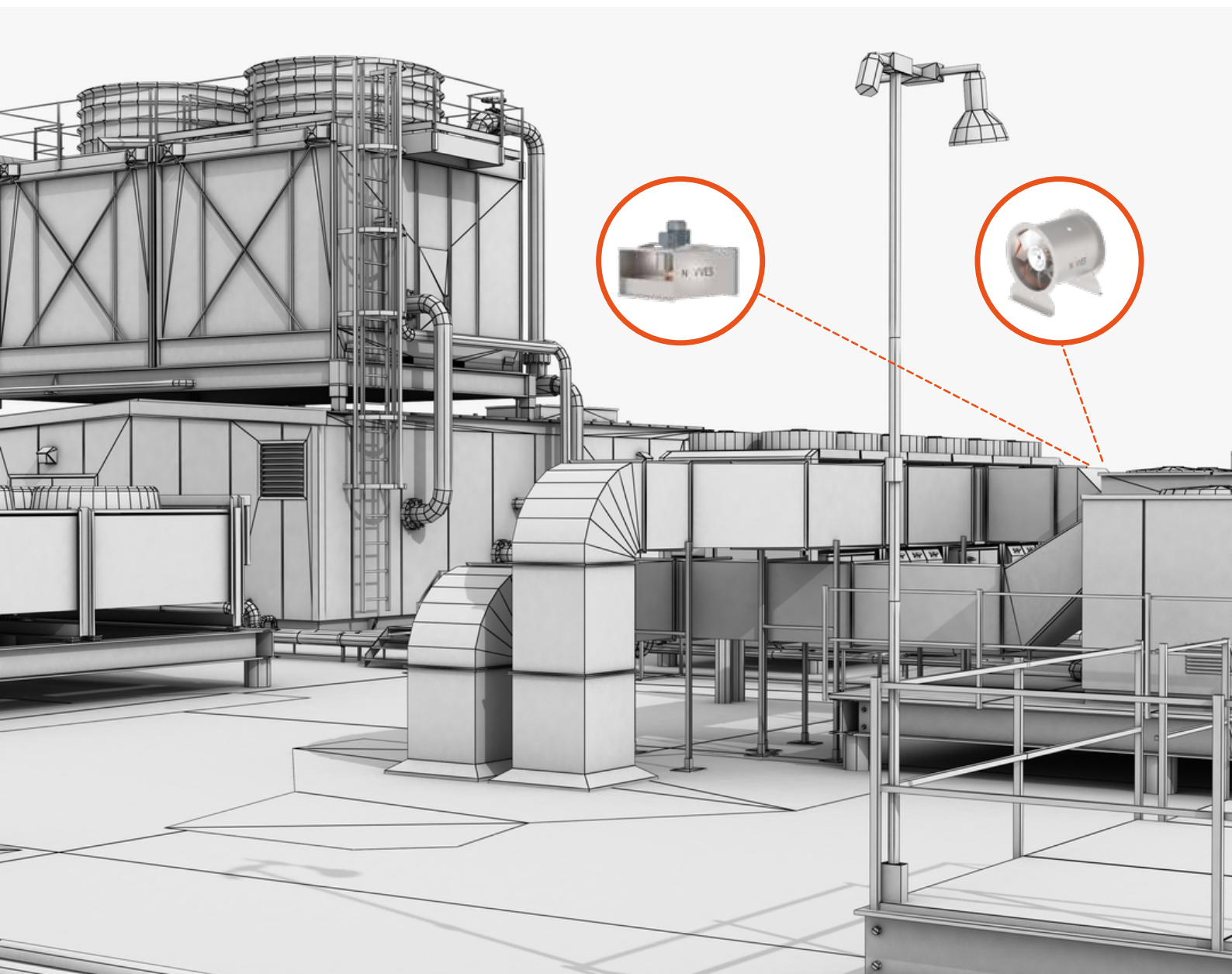

Bear
ATEX Fan

BEAR SERIES



General

Bear series fans, in which Exproof Motors are used, are used in various industrial areas such as chemical plants, purification and paint plants. Fans in this series are equipped with a spark arresting inlet cone made of copper material. The fans in the series are in the II 2G Ex db IIC T4 protection class.

Body

The body is made of galvanized sheet. Coating options with epoxy paint or electrostatic powder paint are also available. The suction and discharge nozzles of rectangular duct fan are designed with flanges.

Motor

Three-phase 2-pole and 4-pole Exproof asynchronous motors are used in the series.

Impeller

The blades of the rectangular duct fan are backward curved and sparsely designed and provide regular flow. Hive type ex-proof fan blades consist of glass-reinforced polymer blades with axial aerofoil structure.

IP Class

All products of this series have IP 65 class protection and F class insulation.

Fan Code

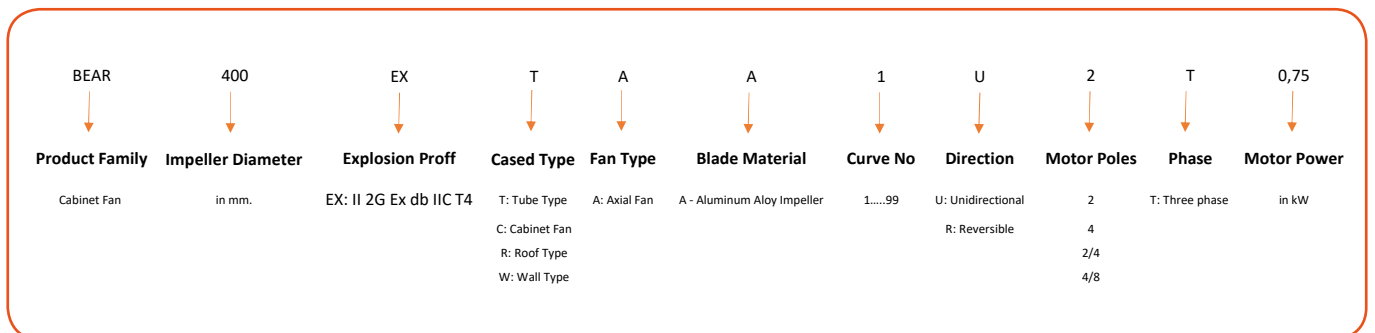

Classification system	Hazardous Explosive Atmosphere	Equipment category
Zone 0	Frequently	1G
Zone 1	Occasionally	2G
Zone 2	Short periods	3G
Mining	-	M1 and M2

Areas with potentially explosive gases
IIA - Propane
IIB - Ethylene
IIC - Hydrogen

Areas with potentially explosive gases	
T1	450 °C
T2	300 °C
T3	200 °C
T4	135 °C
T5	100 °C
T6	85 °C

EXPROOF RECTUNGULAR DUCT FANS



- Body manufactured from high quality galvanized sheet
- II 2G Ex db IIC T4 Protection Class
- Three-phase motors suitable for working with frequency inverters
- Inlet cone made of spark-proof copper material
- Rotational speed can be set with frequency inverter

BEAR REB EX - SYSTEM CURVE

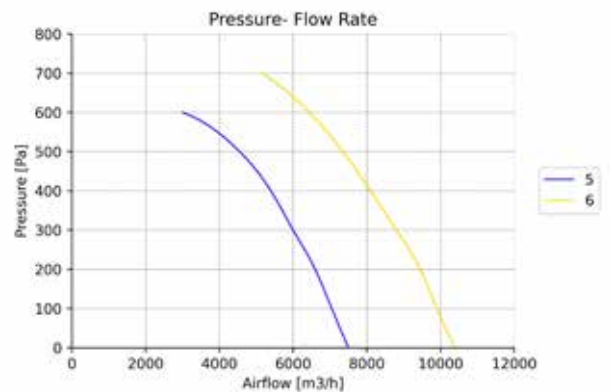
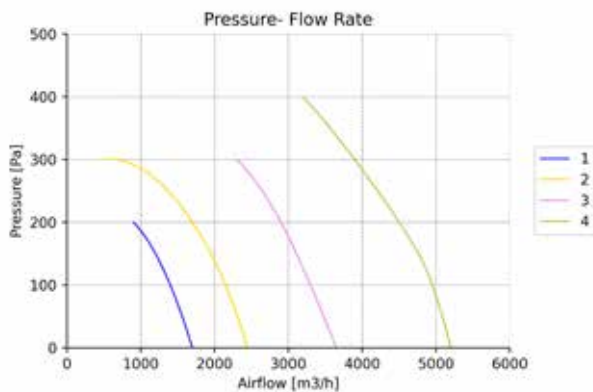

TECHNICAL PARAMETERS

MODEL	MODEL NUMBER	Voltage	Motor	Current	Rotation	Sound	Protection	Working	Mass
		Frequency	Power		Speed	Pressure	Class	Range	
		V-Hz	kW	A	RPM	Lp(A) dB at 3m	IP	°C	Kg
BEAR REB EX 50 25T	1	400-50	0,25	0,27	1450	50	IP 65	-25/60	25
BEAR REB EX 60 35TV1	2	400-50	0,25	0,8	1450	53	IP 65	-25/60	39
BEAR REB EX 60 35TV2	3	400-50	0,37	1,2	1450	57	IP 65	-25/60	43,5
BEAR REB EX 70 40TV1	4	400-50	0,55	2,1	1450	68	IP 65	-25/60	55
BEAR REB EX 80-50T	5	400-50	1,1	3,6	1450	72	IP 65	-25/60	73
BEAR REB EX 100-50T	6	400-50	1,5	5,3	1450	65	IP 65	-25/60	105

PRODUCT DIMENSIONS

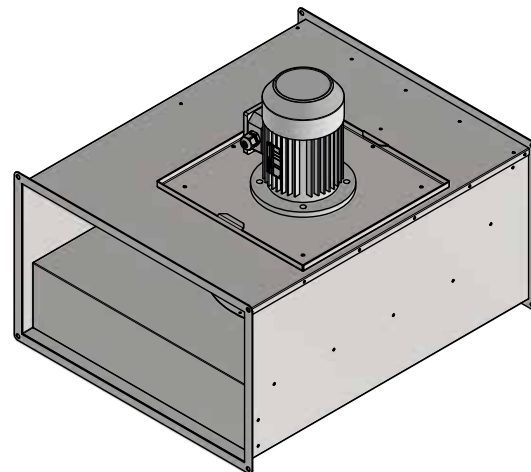
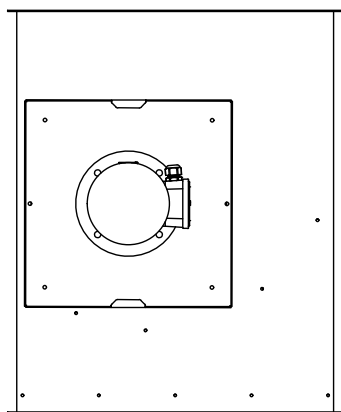
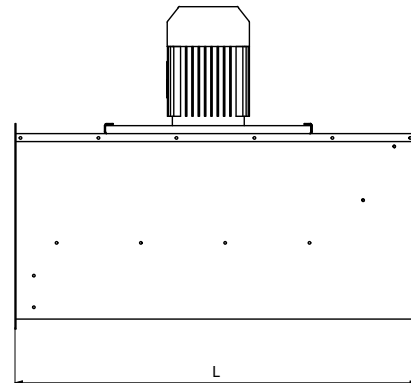
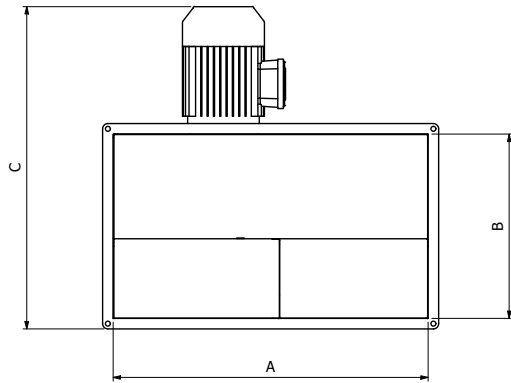

MODEL	A	B	C	L
BEAR REB EX 50 25T	500	250	480	500
BEAR REB EX 60-35TV1	600	350	600	760
BEAR REB EX 60-35TV2	600	350	600	760
BEAR REB EX 70-40TV1	700	400	650	800
BEAR REB EX 80-50T	800	500	800	800
BEAR REB EX 100-50T	1000	500	800	1000

EXPROOF TUBE FANS



- Body is electrostatic powder painted for resistance to corrosion, optionally, body can be manufactured from hot dip galvanized sheet
- II 2G Ex db IIC T4 Protection Class
- Three-phase motors suitable for working with frequency inverters
- Dynamically balanced aluminum impeller in accordance with ISO 1940
- Rotational speed can be set with frequency inverter

BEAR EX - T - SYSTEM CURVE - 2 POLES

Ø400 / 3-4-5 Blade

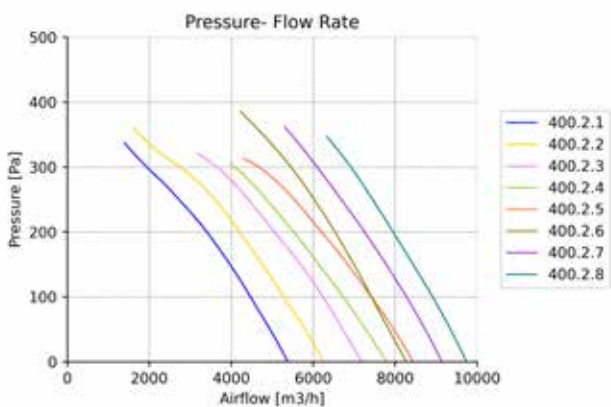

Ø400 / 6-8-10 Blade

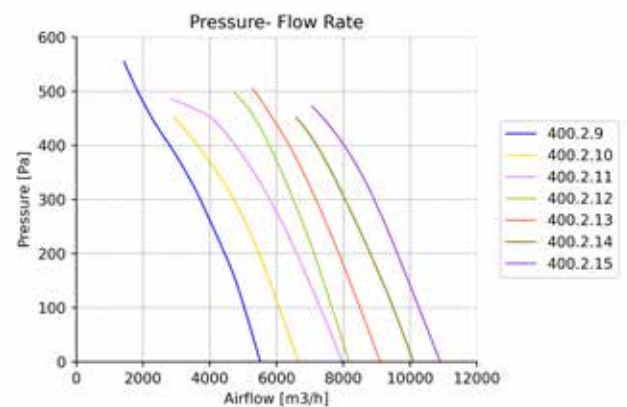

Ø450 / 3-4-6 Blade

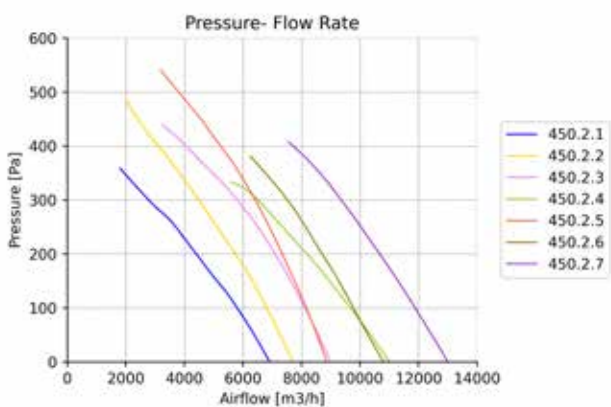

Ø450 / 5-6-8 Blade

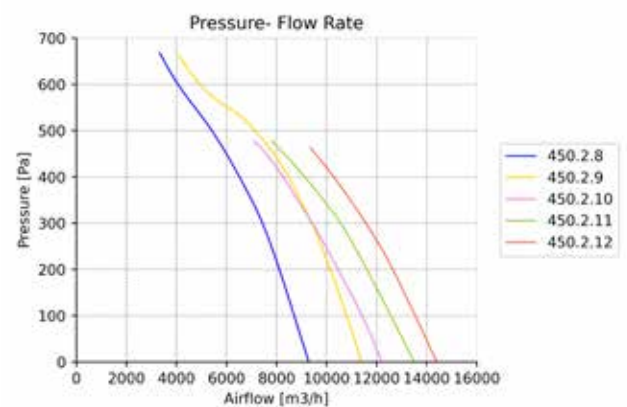

BEAR EX - T - SYSTEM CURVE - 2 POLES

Ø450 / 10 Blade

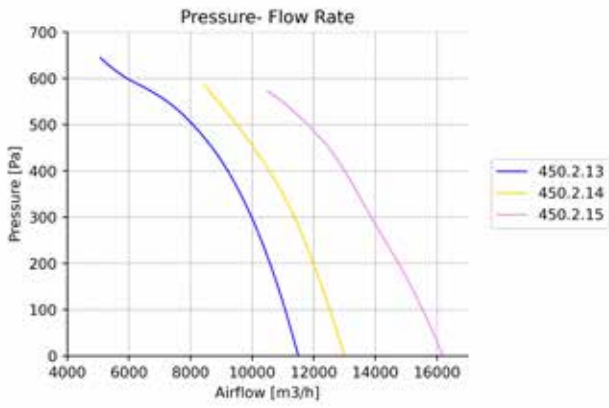

Ø500 / 3-4 Blade

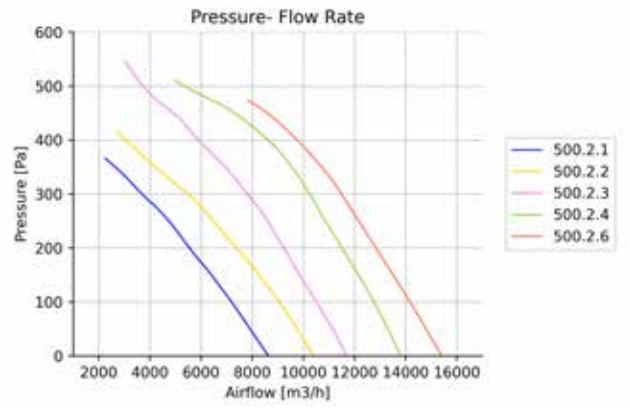

Ø500 / 5 Blade

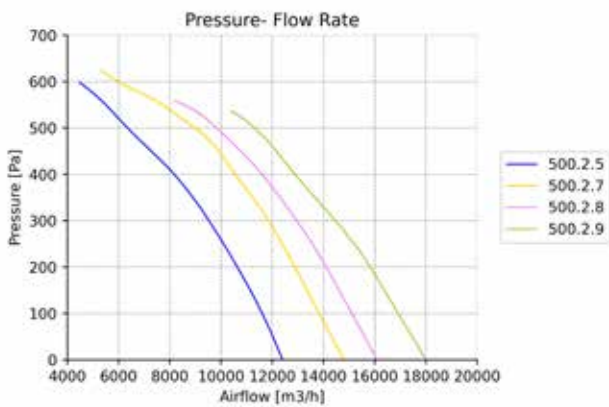

Ø500 / 10 Blade

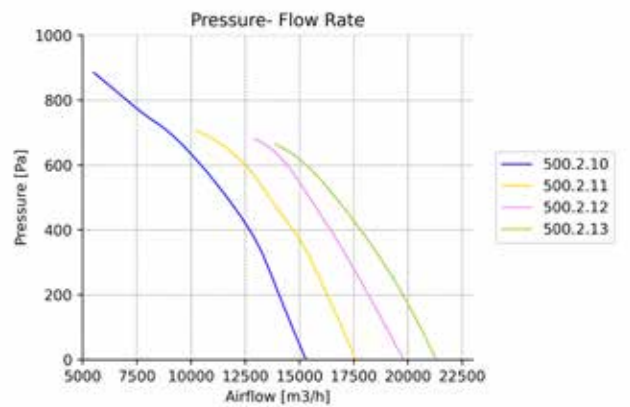

Ø560 / 3-4-5 Blade

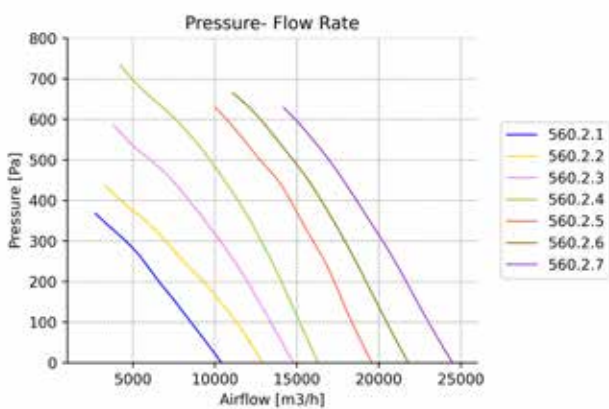

Ø560 / 6 Blade

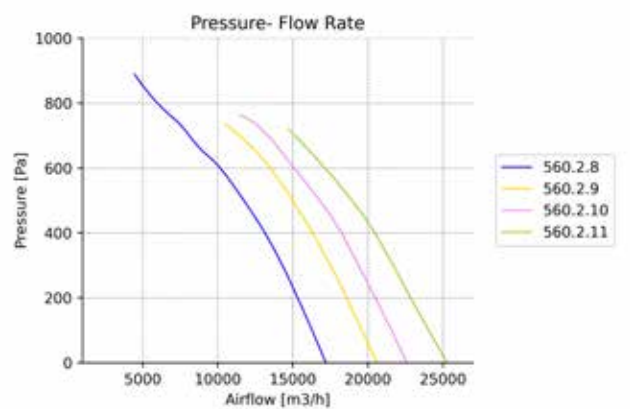

BEAR EX - T - SYSTEM CURVE - 2 POLES

Ø560 / 10 Blade

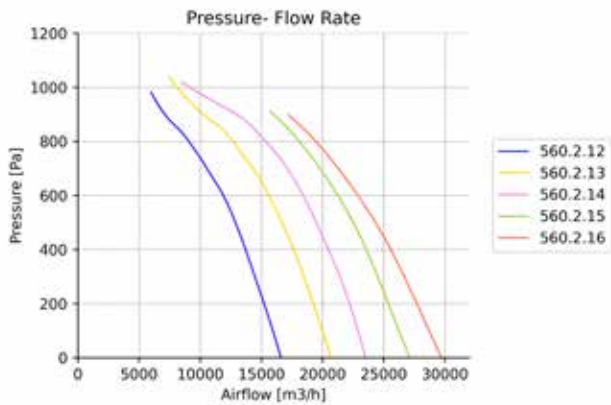

Ø630 / 3-4-5-6 Blade

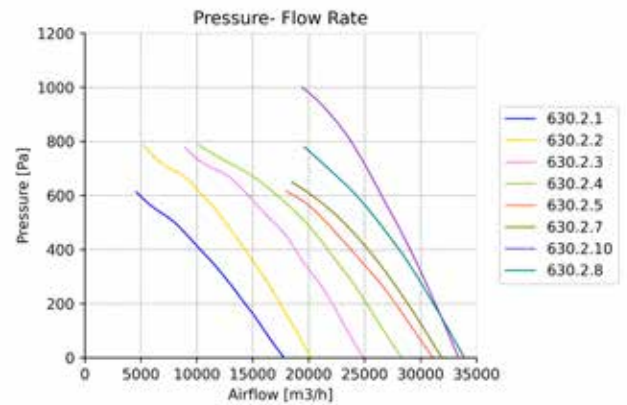

Ø630 / 6-10-12 Blade

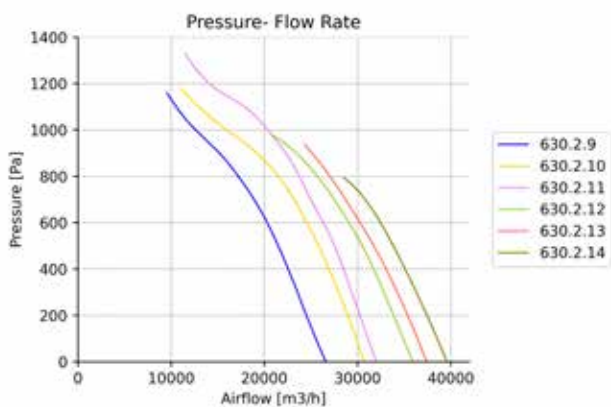

Ø710 / 3-6 Blade

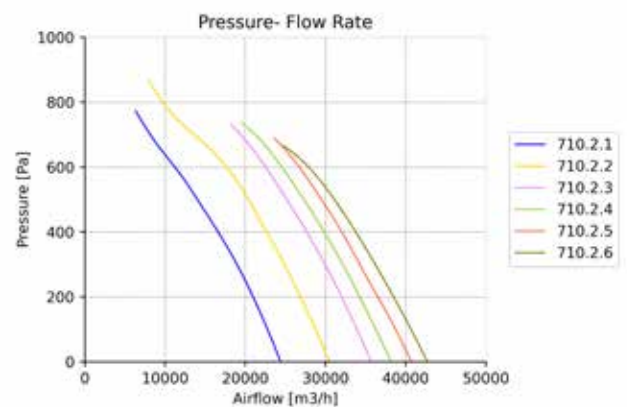

Ø710 / 6-12 Blade

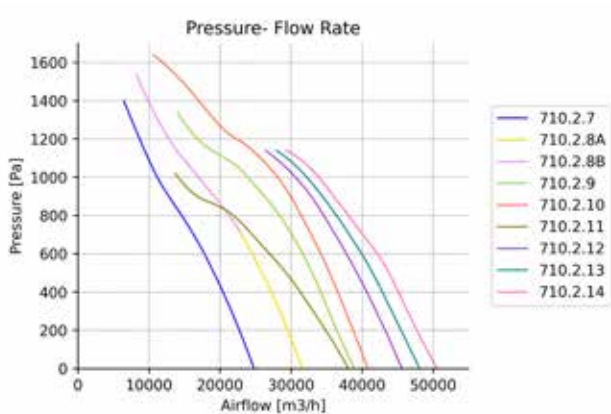

Ø800 / 3-6 Blade

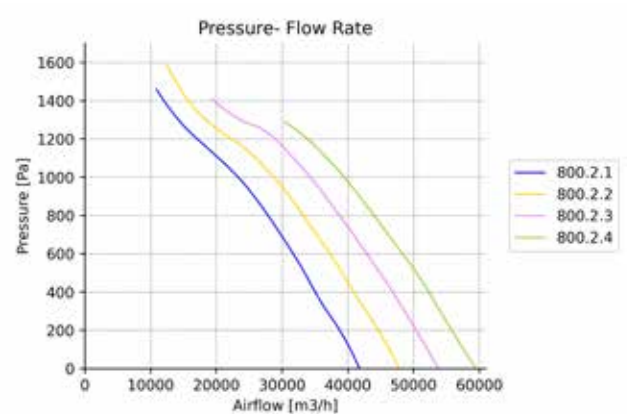

BEAR EX - T - SYSTEM CURVE - 2 POLES

Ø800 / 6-6 Blade

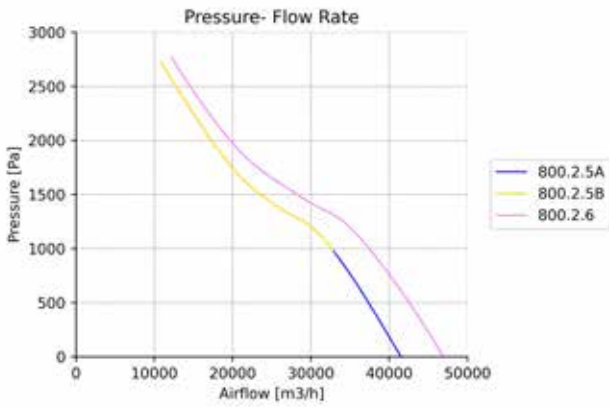

BEAR EX - T - SYSTEM CURVE - 4 POLES

Ø400 / 6-8 Blade

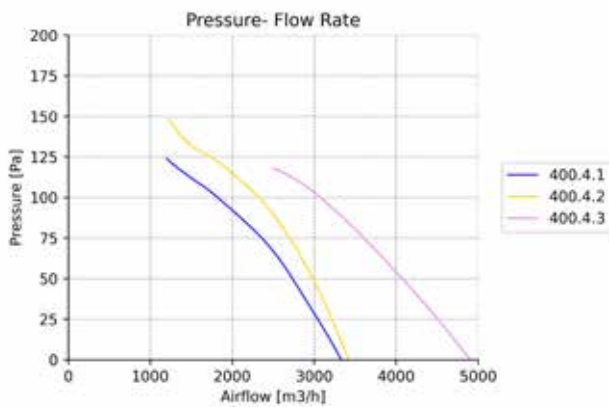

Ø450 / 6-8-10 Blade

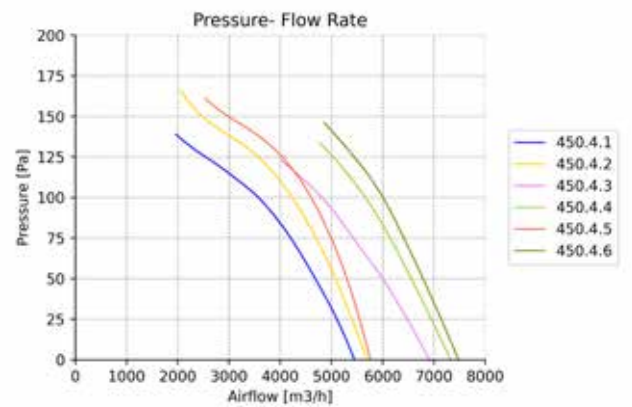

Ø500 / 6-8-10-12 Blade

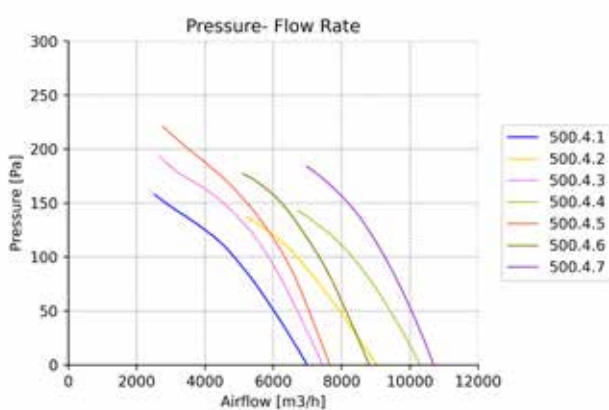

Ø560 / 3-4-6-8 Blade

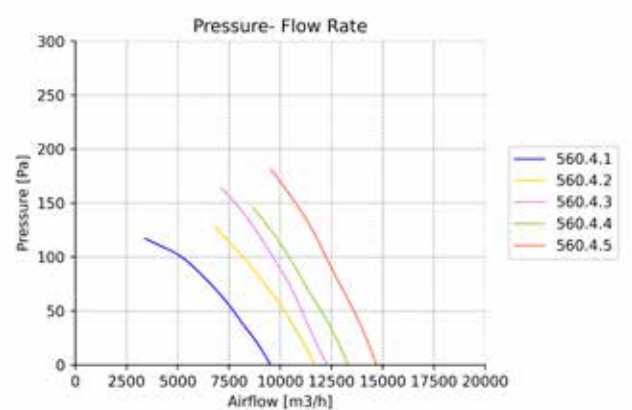

BEAR EX - T - SYSTEM CURVE - 4 POLES

Ø560 / 10-12 Blade

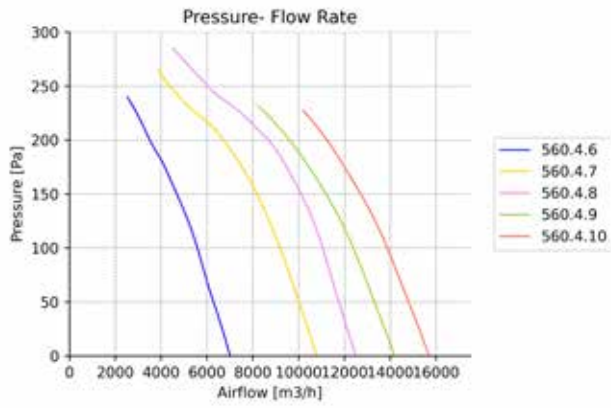

Ø630 / 5-6-8 Blade

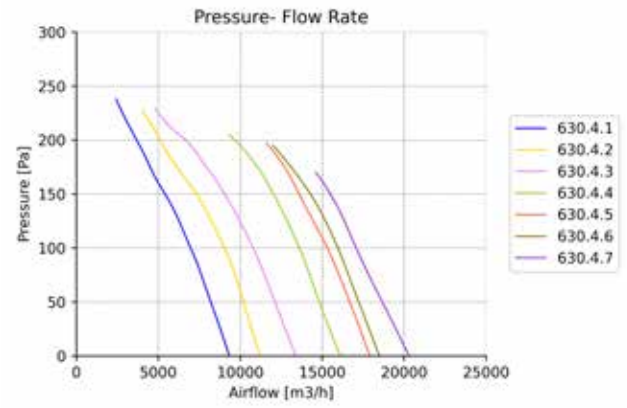

Ø630 / 10-12 Blade

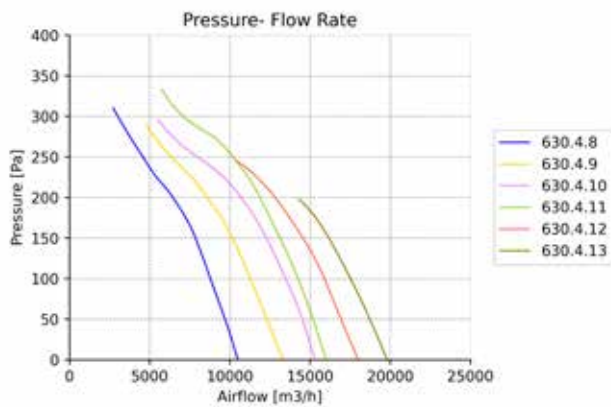

Ø630 / 9-12 Blade

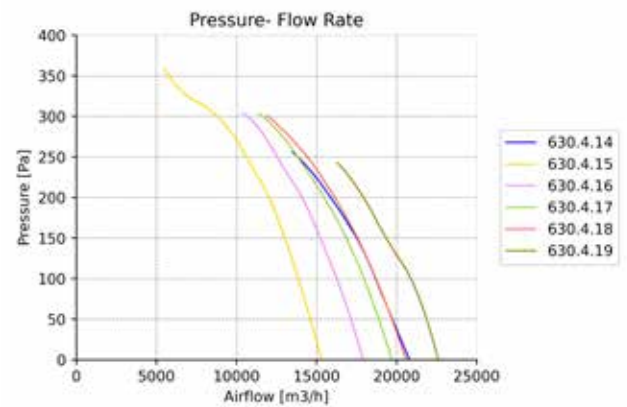

Ø710 / 5-6 Blade

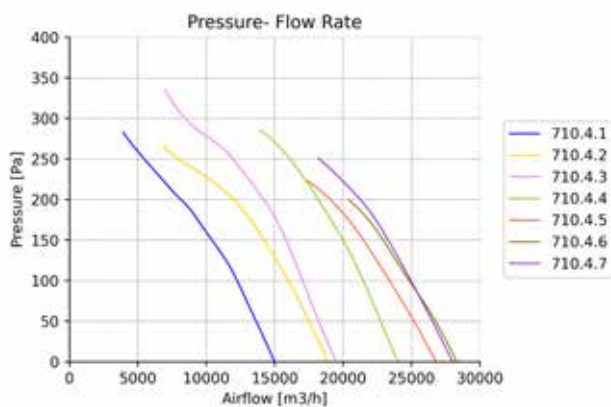

Ø710 / 9-12 Blade

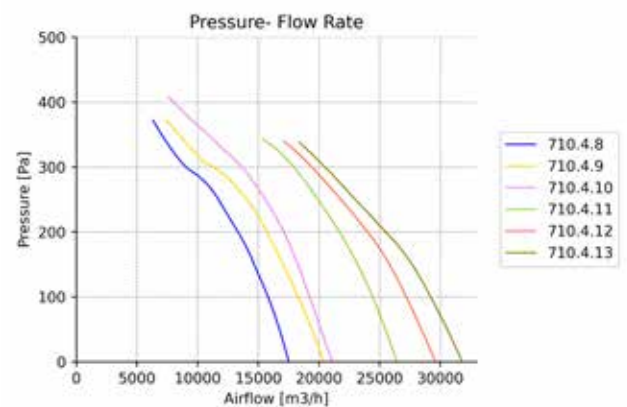

BEAR EX - T - SYSTEM CURVE - 4 POLES

Ø800 / 6 Blade

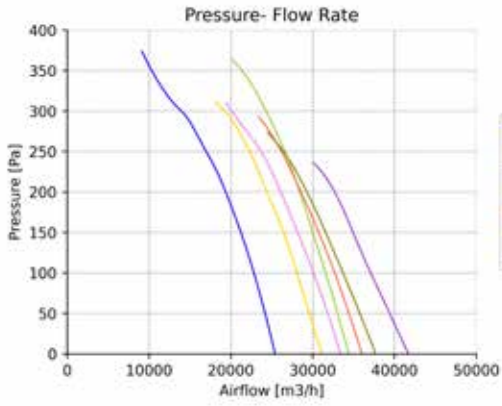

Ø800 / 8 Blade

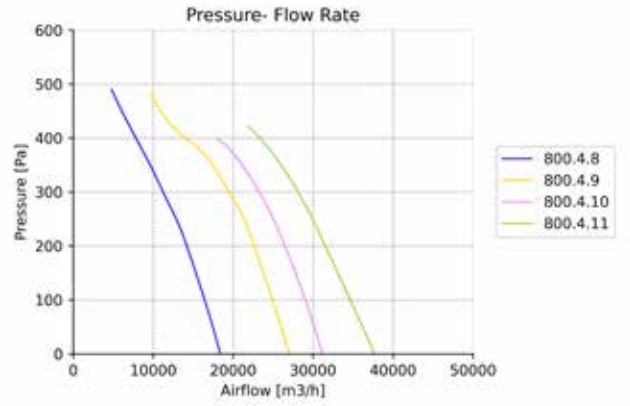

Ø800 / 9-12 Blade

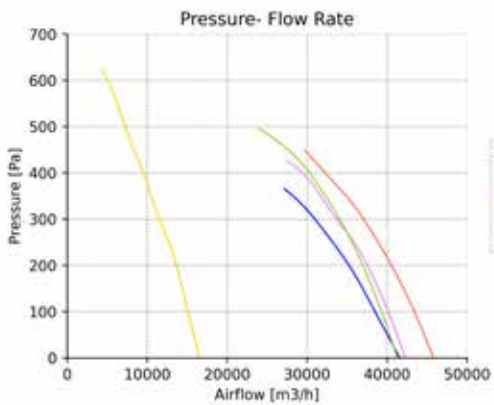

Ø800 / 6 Blade

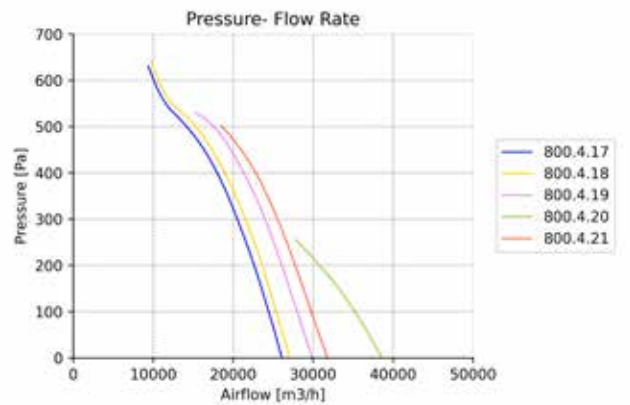

Ø900 / 6 Blade

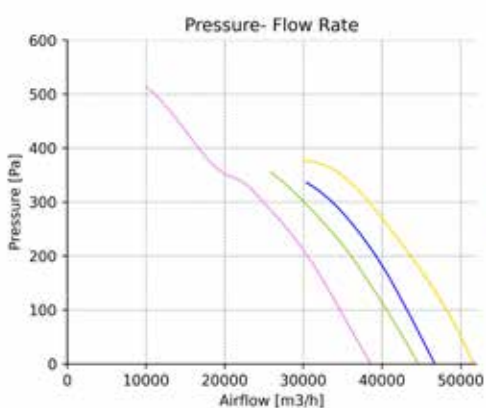

Ø900 / 8 Blade

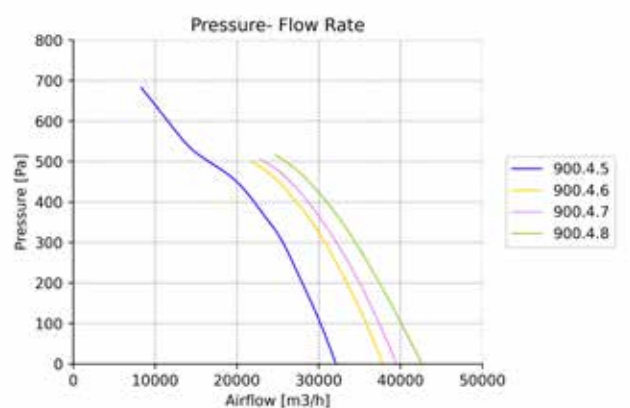

BEAR EX - T - SYSTEM CURVE - 4 POLES

Ø900 / 9 Blade

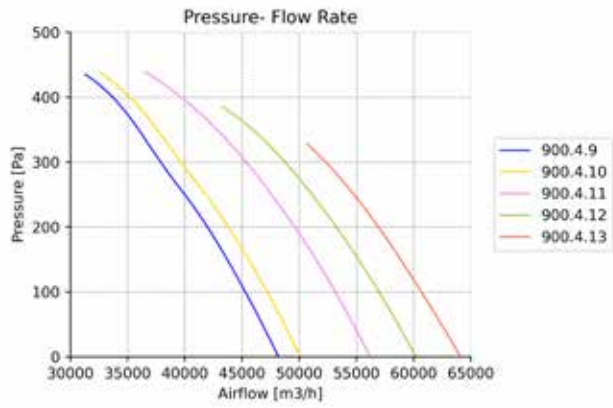

Ø900 / 12 Blade

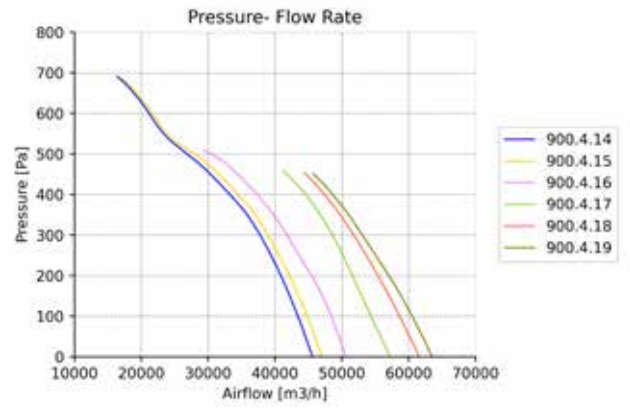

Ø900 / 6 Blade

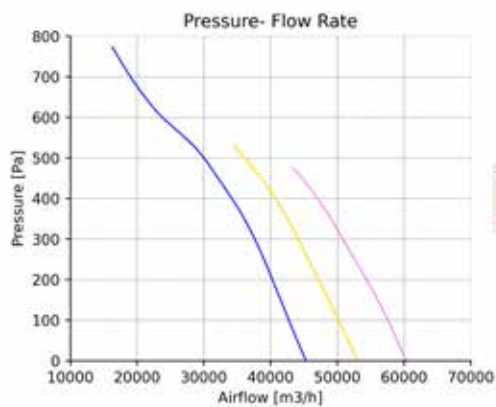

Ø1000 / 3 Blade

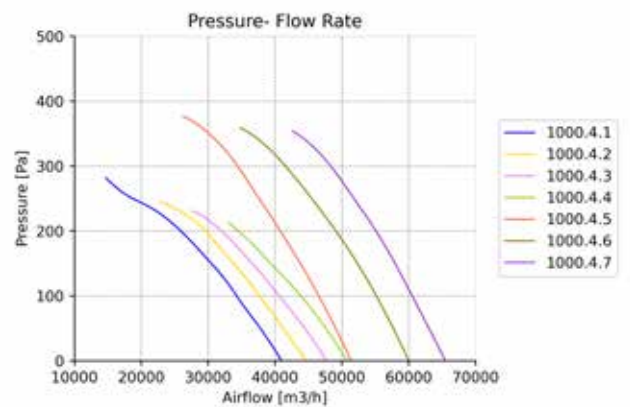

Ø1000 / 5-6 Blade

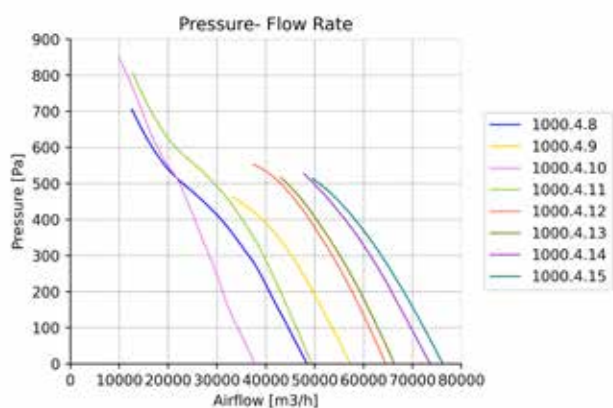

Ø1000 / 6 Blade

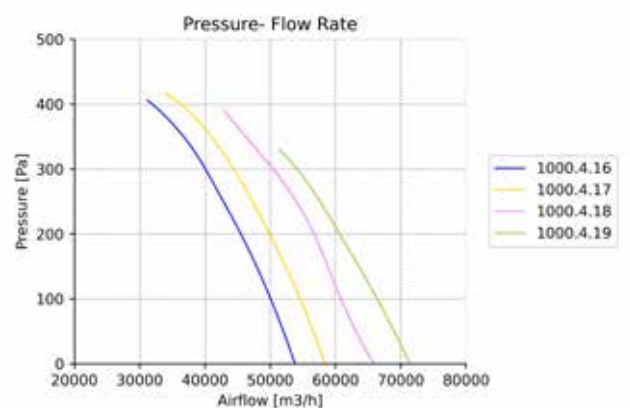

BEAR EX - T - SYSTEM CURVE - 4 POLES

Ø1000 / 6 Blade

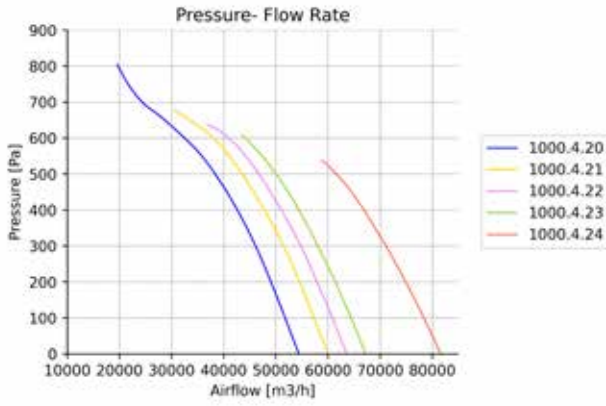

Ø1000 / 8 Blade

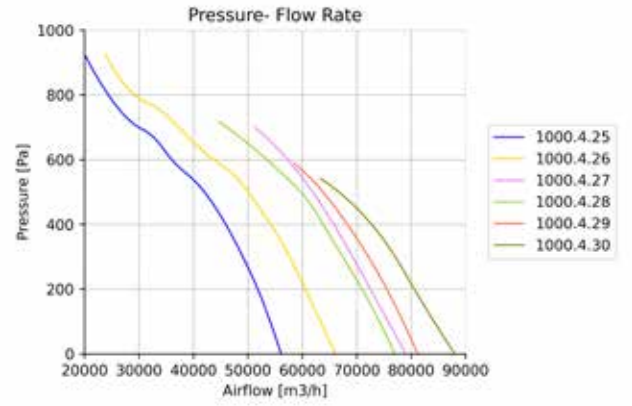

Ø1000 / 9 Blade

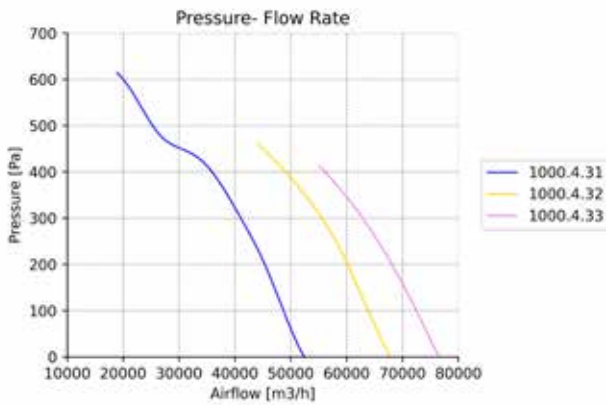

Ø1000 / 10 Blade

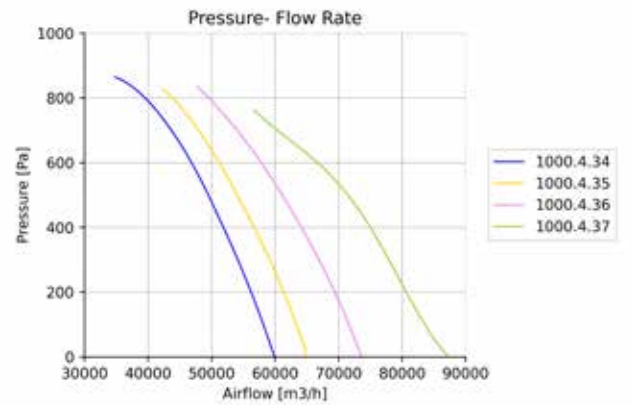

Ø1120 / 3 Blade

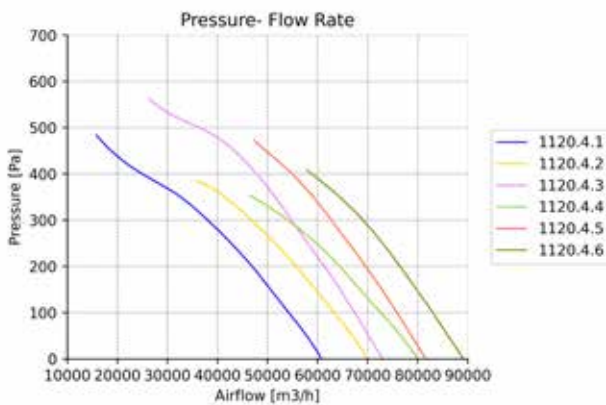

Ø1120 / 6 Blade

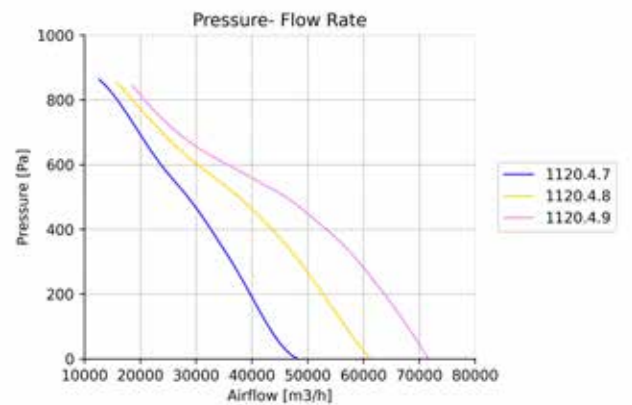

BEAR EX - T - SYSTEM CURVE - 4 POLES

Ø1120 / 6 Blade

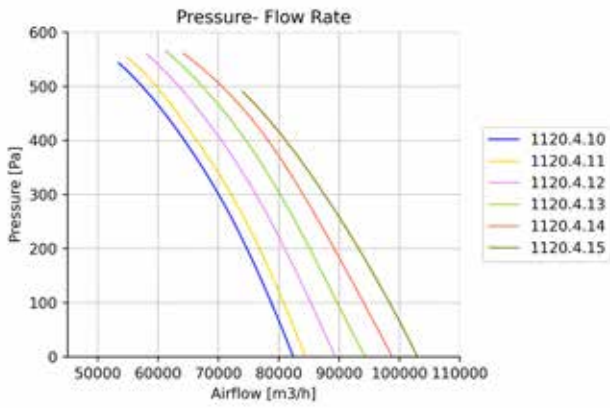

Ø1120 / 6 Blade

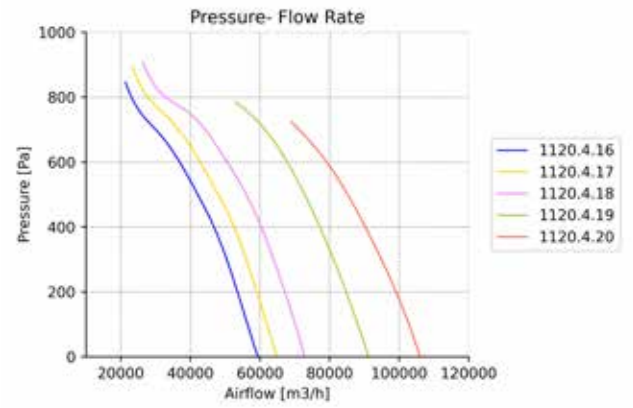

Ø1120 / 8 Blade

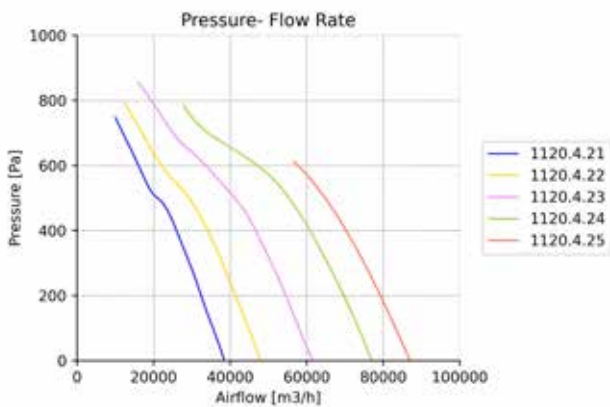

Ø1120 / 8 Blade

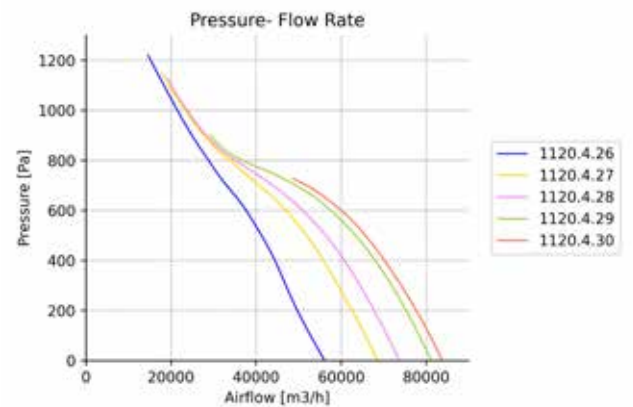

Ø1120 / 8 Blade

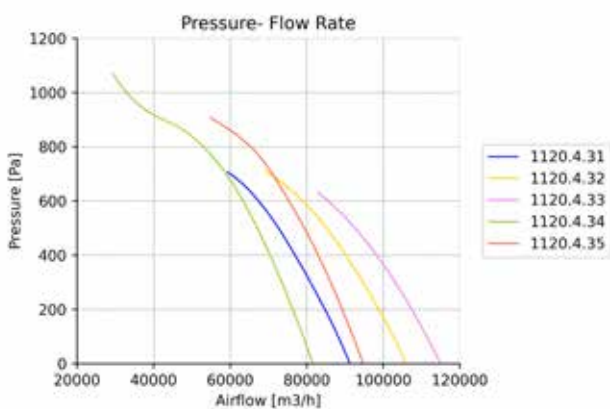

Ø1120 / 10-12 Blade

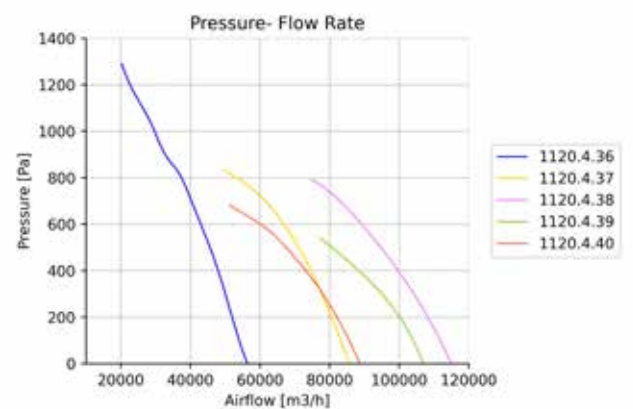

BEAR EX - T - SYSTEM CURVE - 4 POLES

Ø1250 / 3 Blade

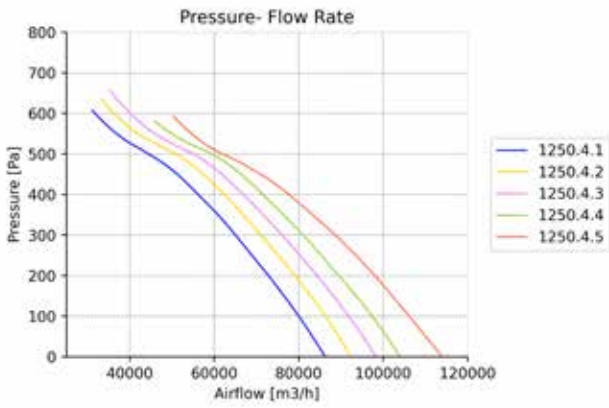

Ø1250 / 6 Blade

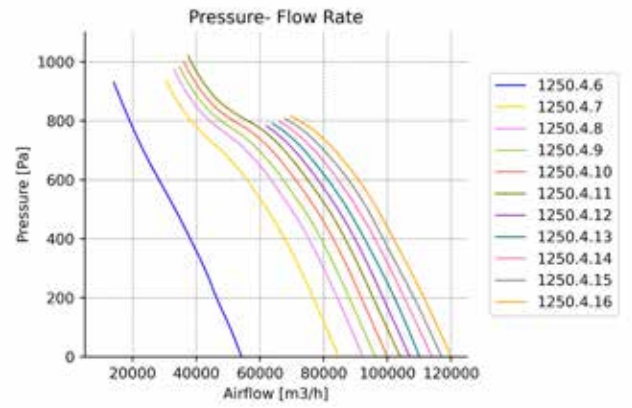

Ø1250 / 6 Blade

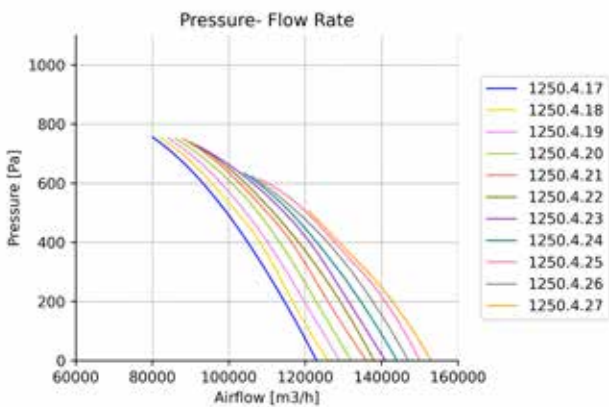

Ø1250 / 8 Blade

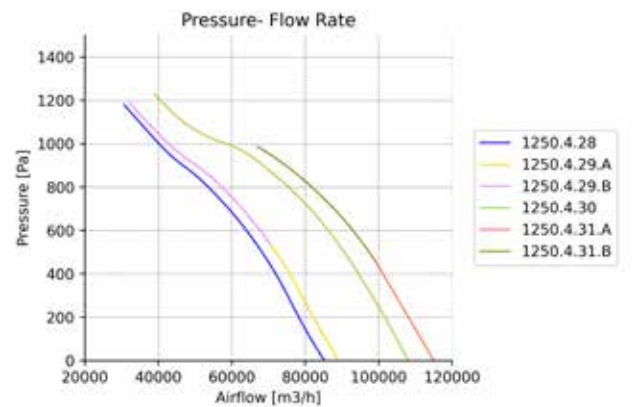

Ø1250 / 8 Blade

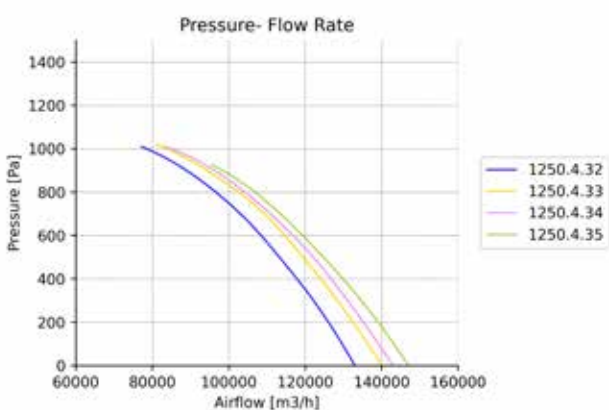

Ø1250 / 5 Blade

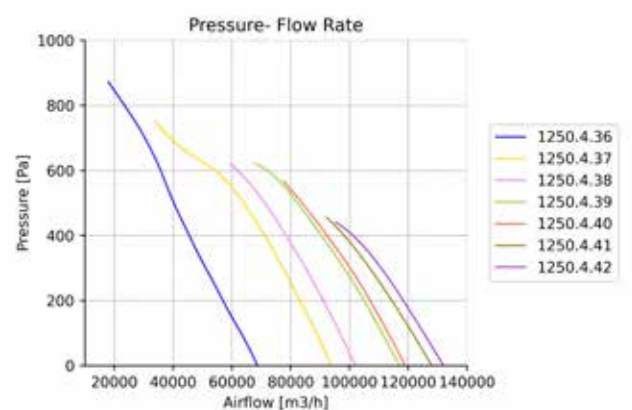

PRODUCT DIMENSIONS

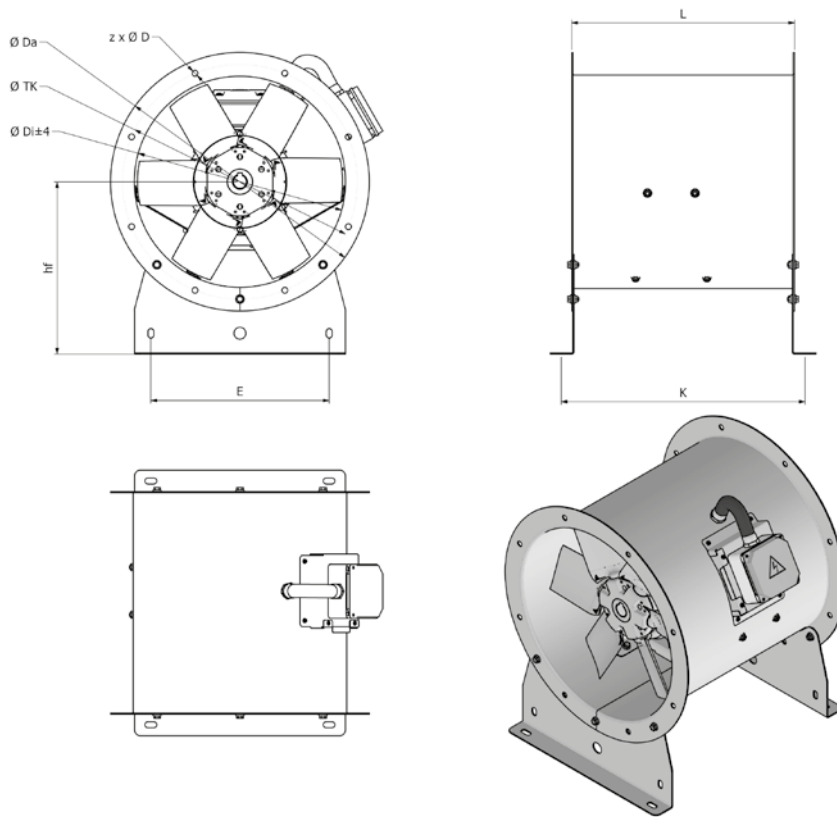

ØDi	2 Poles	4 Poles	ØTK	ØDa	z x ØD	L	E	K	hf
400	0,75--1,1	0,55--0,75	450	480	8 x 12	400	345	435	315
400	1,5--2,2	1,1--1,5	450	480	8 x 12	520	345	555	315
400	3	2,2--3	450	480	8 x 12	520	345	555	315
450	0,37--0,55	0,37	500	530	8 x 12	450	395	485	340
450	0,75--1,1	0,55--0,75	500	530	8 x 12	450	395	485	340
450	1,5--2,2	1,1--1,5	500	530	8 x 12	570	395	605	340
450	3	2,2--3	500	530	8 x 12	570	395	605	340
450	4	4	500	530	8 x 12	640	395	675	340
450	5,5--7,5	5,5--7,5	500	530	8 x 12	640	395	675	340
500	0,37--0,55	0,37	560	590	12 x 12	450	440	490	390
500	0,75--1,1	0,55--0,75	560	590	12 x 12	450	440	490	390
500	1,5--2,2	1,1--1,5	560	590	12 x 12	570	440	610	390
500	3	2,2--3	560	590	12 x 12	570	440	610	390
500	4	4	560	590	12 x 12	640	440	680	390
500	5,5--7,5	5,5--7,5	560	590	12 x 12	640	440	680	390
560	0,37--0,55	0,37	620	650	12 x 12	570	500	610	420
560	0,75--1,1	0,55--0,75	620	650	12 x 12	570	500	610	420
560	1,5--2,2	1,1--1,5	620	650	12 x 12	570	500	610	420
560	3	2,2--3	620	650	12 x 12	570	500	610	420
560	4	4	620	650	12 x 12	640	500	680	420

ØDi	2 Poles	4 Poles	ØTK	ØDa	z x ØD	L	E	K	hf
560	5,5--7,5	5,5--7,5	620	650	12 x 12	640	500	680	420
560	15--18,5	11--15	620	650	12 x 12	750	500	790	420
630	0,37--0,55	0,37	690	720	12 x 12	570	570	610	455
630	0,75--1,1	0,55--0,75	690	720	12 x 12	570	570	610	455
630	1,5--2,2	1,1--1,5	690	720	12 x 12	570	570	610	455
630	3	2,2--3	690	720	12 x 12	570	570	610	455
630	4	4	690	720	12 x 12	640	570	680	455
630	5,5--7,5	5,5--7,5	690	720	12 x 12	640	570	680	455
630	15--18,5	11--15	690	720	12 x 12	750	570	790	455
710	0,75--1,1	0,55--0,75	770	800	16 x 12	570	650	620	525
710	1,5--2,2	1,1--1,5	770	800	16 x 12	570	650	620	525
710	3	2,2--3	770	800	16 x 12	570	650	620	525
710	4	4	770	800	16 x 12	640	650	690	525
710	5,5--7,5	5,5--7,5	770	800	16 x 12	640	650	690	525
710	15--18,5	11--15	770	800	16 x 12	850	650	900	525
710	22	18,5--22	770	800	16 x 12	850	650	900	525
710	30--37	30--37	770	800	16 x 12	850	650	900	525
800	0,75--1,1	0,55--0,75	860	890	16 x 12	570	730	620	570
800	1,5--2,2	1,1--1,5	860	890	16 x 12	570	730	620	570
800	3	2,2--3	860	890	16 x 12	570	730	620	570
800	4	4	860	890	16 x 12	700	730	750	570
800	5,5--7,5	5,5--7,5	860	890	16 x 12	700	730	750	570
800	15--18,5	11--15	860	890	16 x 12	850	730	900	570
800	22	18,5--22	860	890	16 x 12	850	730	900	570
800	30--37	30--37	860	890	16 x 12	850	730	900	570
900	-	0,55--0,75	970	1005	16 x 15	570	830	620	620
900	-	1,1--1,5	970	1005	16 x 15	570	830	620	620
900	-	2,2--3	970	1005	16 x 15	570	830	620	620
900	-	4	970	1005	16 x 15	700	830	750	620
900	-	5,5--7,5	970	1005	16 x 15	700	830	750	620
900	-	11--15	970	1005	16 x 15	850	830	900	620
900	-	18,5--22	970	1005	16 x 15	850	830	900	620
900	-	30--37	970	1005	16 x 15	850	830	900	620
1000	-	0,55--0,75	1070	1105	16 x 15	570	930	620	670
1000	-	1,1--1,5	1070	1105	16 x 15	570	930	620	670
1000	-	2,2--3	1070	1105	16 x 15	570	930	620	670
1000	-	4	1070	1105	16 x 15	700	930	750	670
1000	-	5,5--7,5	1070	1105	16 x 15	700	930	750	670
1000	-	11--15	1070	1105	16 x 15	950	930	1000	670
1000	-	18,5--22	1070	1105	16 x 15	950	930	1000	670

ØDi	2 Poles	4 Poles	ØTK	ØDa	z x ØD	L	E	K	hf
1000	-	30--37	1070	1105	16 x 15	950	930	1000	670
1000	-	45--55	1070	1105	16 x 15	950	930	1000	670
1120	-	4	1190	1260	20 x 15	750	1020	812	764
1120	-	5,5--7,5	1190	1260	20 x 15	750	1020	812	764
1120	-	11--15	1190	1260	20 x 15	800	1020	862	764
1120	-	18,5--22	1190	1260	20 x 15	800	1020	862	764
1120	-	30--37	1190	1260	20 x 15	950	1020	1012	764
1120	-	45--55	1190	1260	20 x 15	950	1020	1012	764
1250	-	4	1320	1390	20 x 15	700	1150	760	825
1250	-	5,5--7,5	1320	1390	20 x 15	700	1150	760	825
1250	-	11--15	1320	1390	20 x 15	800	1150	860	825
1250	-	18,5--22	1320	1390	20 x 15	800	1150	860	825
1250	-	30--37	1320	1390	20 x 15	1000	1150	1060	825
1250	-	45--55	1320	1390	20 x 15	1000	1150	1060	825
1250	-	75	1320	1390	20 x 15	1000	1150	1060	825

TECHNICAL PARAMETERS

MODEL	MODEL NUMBER	Voltage Frequency	Motor Power	Current	Rotation Speed	Sound Pressure	Protection Class	Working Range	Mass
		V-Hz	kW	A	RPM	Lp(A) dB at 3m	IP	°C	~ Kg
BEAR 400EX-TAA1U-2T0,37	400.2.1	400-50	0,37	1,05	2880	64,5	65	-20/40	33
BEAR 400EX-TAA2U-2T0,55	400.2.2	400-50	0,55	1,3	2880	62,5	65	-20/40	34
BEAR 400EX-TAA3U-2T0,75	400.2.3	400-50	0,75	1,75	2880	63,8	65	-20/40	35
BEAR 400EX-TAA4U-2T0,75	400.2.4	400-50	0,75	1,75	2880	64,6	65	-20/40	35
BEAR 400EX-TAA5U-2T1,1	400.2.5	400-50	1,1	2,55	2880	67,2	65	-20/40	45
BEAR 400EX-TAA6U-2T1,1	400.2.6	400-50	1,1	2,55	2880	64,5	65	-20/40	45
BEAR 400EX-TAA7U-2T1,5	400.2.7	400-50	1,5	3,5	2880	67	65	-20/40	49
BEAR 400EX-TAA8U-2T2,2	400.2.8	400-50	2,2	4,9	2880	69,4	65	-20/40	55
BEAR 400EX-TAA9U-2T0,75	400.2.9	400-50	0,75	1,75	2880	67,6	65	-20/40	35
BEAR 400EX-TAA10U-2T0,75	400.2.10	400-50	0,75	1,75	2880	65,6	65	-20/40	35
BEAR 400EX-TAA11U-2T1,1	400.2.11	400-50	1,1	2,55	2880	64,2	65	-20/40	45
BEAR 400EX-TAA12U-2T1,5	400.2.12	400-50	1,5	3,5	2880	65,4	65	-20/40	49
BEAR 400EX-TAA13U-2T1,5	400.2.13	400-50	1,5	3,5	2880	65,2	65	-20/40	49
BEAR 400EX-TAA14U-2T2,2	400.2.14	400-50	2,2	4,9	2880	65,5	65	-20/40	55
BEAR 400EX-TAA15U-2T3	400.2.15	400-50	3	6,5	2880	68,3	65	-20/40	66
BEAR 450EX-TAA1U-2T0,55	450.2.1	400-50	0,55	1,3	2880	68	65	-20/40	37
BEAR 450EX-TAA2U-2T0,75	450.2.2	400-50	0,75	1,75	2880	71,9	65	-20/40	39
BEAR 450EX-TAA3U-2T1,1	450.2.3	400-50	1,1	2,55	2880	66,9	65	-20/40	49
BEAR 450EX-TAA4U-2T1,1	450.2.4	400-50	1,1	2,55	2880	68,3	65	-20/40	48
BEAR 450EX-TAA5U-2T1,1	450.2.5	400-50	1,1	2,55	2880	72	65	-20/40	49
BEAR 450EX-TAA6U-2T1,5	450.2.6	400-50	1,5	3,5	2880	66,3	65	-20/40	53
BEAR 450EX-TAA7U-2T2,2	450.2.7	400-50	2,2	4,9	2880	69,4	65	-20/40	58
BEAR 450EX-TAA8U-2T1,5	450.2.8	400-50	1,5	3,5	2880	71,3	65	-20/40	53
BEAR 450EX-TAA9U-2T2,2	450.2.9	400-50	2,2	4,9	2880	69,6	65	-20/40	59
BEAR 450EX-TAA10U-2T2,2	450.2.10	400-50	2,2	4,9	2880	68,9	65	-20/40	59
BEAR 450EX-TAA11U-2T3	450.2.11	400-50	3	6,5	2880	70	65	-20/40	70
BEAR 450EX-TAA12U-2T4	450.2.12	400-50	4	8,2	2880	73,2	65	-20/40	79
BEAR 450EX-TAA13U-2T3	450.2.13	400-50	3	6,5	2880	68,4	65	-20/40	70
BEAR 450EX-TAA14U-2T3	450.2.14	400-50	3	6,5	2880	68,4	65	-20/40	70
BEAR 450EX-TAA15U-2T5,5	450.2.15	400-50	5,5	11	2880	69,7	65	-20/40	109
BEAR 500EX-TAA1U-2T0,75	500.2.1	400-50	0,75	1,75	2880	75,3	65	-20/40	51
BEAR 500EX-TAA2U-2T1,1	500.2.2	400-50	1,1	2,55	2880	69,8	65	-20/40	63
BEAR 500EX-TAA3U-2T1,5	500.2.3	400-50	1,5	3,5	2880	71,2	65	-20/40	67
BEAR 500EX-TAA4U-2T2,2	500.2.4	400-50	2,2	4,9	2880	69,4	65	-20/40	73
BEAR 500EX-TAA5U-2T2,2	500.2.6	400-50	2,2	4,9	2880	68,9	65	-20/40	73
BEAR 500EX-TAA6U-2T2,2	500.2.5	400-50	2,2	4,9	2880	65,8	65	-20/40	73
BEAR 500EX-TAA7U-2T3	500.2.7	400-50	3	6,5	2880	69,4	65	-20/40	84
BEAR 500EX-TAA8U-2T3	500.2.8	400-50	3	6,5	2880	73	65	-20/40	84
BEAR 500EX-TAA9U-2T4	500.2.9	400-50	4	8,2	2880	73,5	65	-20/40	94
BEAR 500EX-TAA10U-2T4	500.2.10	400-50	4	8,2	2880	71,2	65	-20/40	94
BEAR 500EX-TAA11U-2T5,5	500.2.11	400-50	5,5	11	2880	70,9	65	-20/40	125
BEAR 500EX-TAA12U-2T7,5	500.2.12	400-50	7,5	15,4	2880	71,7	65	-20/40	135
BEAR 500EX-TAA13U-2T7,5	500.2.13	400-50	7,5	15,4	2880	71,7	65	-20/40	135
BEAR 560EX-TAA1U-2T0,75	560.2.1	400-50	0,75	1,75	2880	71,7	65	-20/40	60
BEAR 560EX-TAA2U-2T1,1	560.2.2	400-50	1,1	2,55	2880	69,4	65	-20/40	67
BEAR 560EX-TAA3U-2T1,5	560.2.3	400-50	1,5	3,5	2880	72,7	65	-20/40	71

MODEL	MODEL NUMBER	Voltage Frequency	Motor Power	Current	Rotation Speed	Sound Pressure	Protection Class	Working Range	Mass
		V-Hz	kW	A	RPM	Lp(A) dB at 3m	IP	°C	~ Kg
BEAR 560EX-TAA4U-2T2,2	560.2.4	400-50	2,2	4,9	2880	73	65	-20/40	77
BEAR 560EX-TAA5U-2T4	560.2.5	400-50	4	8,2	2880	71,7	65	-20/40	98
BEAR 560EX-TAA6U-2T4	560.2.6	400-50	4	8,2	2880	72,8	65	-20/40	98
BEAR 560EX-TAA7U-2T5,5	560.2.7	400-50	5,5	11	2880	74,6	65	-20/40	129
BEAR 560EX-TAA8U-2T3	560.2.8	400-50	3	6,5	2880	71,7	65	-20/40	89
BEAR 560EX-TAA9U-2T4	560.2.9	400-50	4	8,2	2880	72,2	65	-20/40	99
BEAR 560EX-TAA10U-2T5,5	560.2.10	400-50	5,5	11	2880	72,5	65	-20/40	129
BEAR 560EX-TAA11U-2T7,5	560.2.11	400-50	7,5	15,4	2880	74,3	65	-20/40	139
BEAR 560EX-TAA12U-2T4	560.2.12	400-50	4	8,2	2880	73,3	65	-20/40	99
BEAR 560EX-TAA13U-2T5,5	560.2.13	400-50	5,5	11	2880	74,7	65	-20/40	129
BEAR 560EX-TAA14U-2T7,5	560.2.14	400-50	7,5	15,4	2880	73,4	65	-20/40	139
BEAR 560EX-TAA15U-2T11	560.2.15	400-50	11	22,4	2880	74,1	65	-20/40	194
BEAR 560EX-TAA16U-2T11	560.2.16	400-50	11	22,4	2880	73,8	65	-20/40	194
BEAR 630EX-TAA1U-2T2,2	630.2.1	400-50	2,2	4,9	2880	72,7	65	-20/40	81
BEAR 630EX-TAA2U-2T3	630.2.2	400-50	3	6,5	2880	73,8	65	-20/40	93
BEAR 630EX-TAA3U-2T5,5	630.2.3	400-50	5,5	11	2880	72,2	65	-20/40	133
BEAR 630EX-TAA4U-2T5,5	630.2.4	400-50	5,5	11	2880	74,3	65	-20/40	133
BEAR 630EX-TAA5U-2T7,5	630.2.5	400-50	7,5	15,4	2880	77,5	65	-20/40	144
BEAR 630EX-TAA6U-2T7,5	630.2.6	400-50	7,5	15,4	2880	75,4	65	-20/40	143
BEAR 630EX-TAA7U-2T11	630.2.7	400-50	11	22,4	2880	77,7	65	-20/40	199
BEAR 630EX-TAA8U-2T11	630.2.8	400-50	11	22,4	2880	75,7	65	-20/40	199
BEAR 630EX-TAA9U-2T7,5	630.2.9	400-50	7,5	15,4	2880	77,4	65	-20/40	144
BEAR 630EX-TAA10U-2T11	630.2.10	400-50	11	22,4	2880	75,6	65	-20/40	199
BEAR 630EX-TAA11U-2T11	630.2.11	400-50	11	22,4	2880	75,7	65	-20/40	199
BEAR 630EX-TAA12U-2T15	630.2.12	400-50	15	28,5	2880	75,6	65	-20/40	210
BEAR 630EX-TAA13U-2T15	630.2.13	400-50	15	28,5	2880	77,7	65	-20/40	210
BEAR 630EX-TAA14U-2T15	630.2.14	400-50	15	28,5	2880	75,5	65	-20/40	210
BEAR 710EX-TAA1U-2T3	710.2.1	400-50	3	6,5	2880	78,8	65	-20/40	100
BEAR 710EX-TAA2U-2T5,5	710.2.2	400-50	5,5	11	2880	76	65	-20/40	141
BEAR 710EX-TAA3U-2T7,5	710.2.3	400-50	7,5	15,4	2880	76,3	65	-20/40	151
BEAR 710EX-TAA4U-2T7,5	710.2.4	400-50	7,5	15,4	2880	77,1	65	-20/40	151
BEAR 710EX-TAA5U-2T11	710.2.5	400-50	11	22,4	2880	77,9	65	-20/40	214
BEAR 710EX-TAA6U-2T11	710.2.6	400-50	11	22,4	2880	78,9	65	-20/40	214
BEAR 710EX-TAA7U-2T5,5	710.2.7	400-50	5,5	11	2880	86,5	65	-20/40	142
BEAR 710EX-TAA8.AU-2T7,5	710.2.8A	400-50	7,5	15,4	2880	82,5	65	-20/40	152
BEAR 710EX-TAA8.BU-2T11	710.2.8B	400-50	11	22,4	2880	82,5	65	-20/40	215
BEAR 710EX-TAA9U-2T15	710.2.9	400-50	15	28,5	2880	75,4	65	-20/40	226
BEAR 710EX-TAA10U-2T11	710.2.10	400-50	11	22,4	2880	80,5	65	-20/40	215
BEAR 710EX-TAA11U-2T15	710.2.11	400-50	15	28,5	2880	77,3	65	-20/40	227
BEAR 710EX-TAA12U-2T15	710.2.12	400-50	15	28,5	2880	80,5	65	-20/40	225
BEAR 710EX-TAA13U-2T18,5	710.2.13	400-50	18,5	35	2880	81,5	65	-20/40	248
BEAR 710EX-TAA14U-2T18,5	710.2.14	400-50	18,5	35	2880	81,5	65	-20/40	248
BEAR 800EX-TAA1U-2T11	800.2.1	400-50	11	22,4	2880	81,5	65	-20/40	229
BEAR 800EX-TAA2U-2T15	800.2.2	400-50	15	28,5	2880	82,5	65	-20/40	239
BEAR 800EX-TAA3U-2T18,5	800.2.3	400-50	18,5	35	2880	84,5	65	-20/40	262
BEAR 800EX-TAA4U-2T22	800.2.4	400-50	22	41,5	2880	85,5	65	-20/40	345

MODEL	MODEL NUMBER	Voltage Frequency	Motor Power	Current	Rotation Speed	Sound Pressure	Protection Class	Working Range	Mass
		V-Hz	kW	A	RPM	Lp(A) dB at 3m	IP	°C	~ Kg
BEAR 800EX-TAA5U-2T18,5	800.2.5	400-50	18,5	35	2880	85,5	65	-20/40	257
BEAR 800EX-TAA6U-2T18,5	800.2.6	400-50	18,5	35	2880	85,5	65	-20/40	257
BEAR 800EX-TAA7U-2T22	800.2.7	400-50	22	41,5	2880	85,5	65	-20/40	340
BEAR 400EX-TAA1U-4T0,37	400.4.1	400-50	0,37	1,15	1440	50,5	65	-20/40	34
BEAR 400EX-TAA2U-4T0,37	400.4.2	400-50	0,37	1,15	1440	50,7	65	-20/40	34
BEAR 400EX-TAA3U-4T0,37	400.4.3	400-50	0,37	1,15	1440	51,6	65	-20/40	34
BEAR 450EX-TAA1U-4T0,37	450.4.1	400-50	0,37	1,15	1440	52,7	65	-20/40	38
BEAR 450EX-TAA2U-4T0,37	450.4.2	400-50	0,37	1,15	1440	54,6	65	-20/40	38
BEAR 450EX-TAA3U-4T0,37	450.4.3	400-50	0,37	1,15	1440	54,7	65	-20/40	38
BEAR 450EX-TAA4U-4T0,55	450.4.4	400-50	0,55	1,6	1440	53,4	65	-20/40	39
BEAR 450EX-TAA5U-4T0,37	450.4.5	400-50	0,37	1,15	1440	53,4	65	-20/40	39
BEAR 450EX-TAA6U-4T0,55	450.4.6	400-50	0,55	1,6	1440	53,4	65	-20/40	39
BEAR 450EX-TAA7U-4T0,75	450.4.7	400-50	0,75	2,1	1440	53,5	65	-20/40	47
BEAR 500EX-TAA1U-4T0,37	500.4.1	400-50	0,37	1,15	1440	51,7	65	-20/40	50
BEAR 500EX-TAA2U-4T0,55	500.4.2	400-50	0,55	1,6	1440	56,5	65	-20/40	51
BEAR 500EX-TAA3U-4T0,37	500.4.3	400-50	0,37	1,15	1440	57,6	65	-20/40	51
BEAR 500EX-TAA4U-4T0,75	500.4.4	400-50	0,75	2,1	1440	56,8	65	-20/40	59
BEAR 500EX-TAA5U-4T0,55	500.4.5	400-50	0,55	1,6	1440	57,8	65	-20/40	52
BEAR 500EX-TAA6U-4T0,75	500.4.6	400-50	0,75	2,1	1440	57,8	65	-20/40	59
BEAR 500EX-TAA7U-4T1,1	500.4.7	400-50	1,1	3,1	1440	58,5	65	-20/40	68
BEAR 560EX-TAA1U-4T0,37	560.4.1	400-50	0,37	1,15	1440	58,6	65	-20/40	59
BEAR 560EX-TAA2U-4T0,55	560.4.2	400-50	0,55	1,6	1440	58,2	65	-20/40	60
BEAR 560EX-TAA3U-4T0,75	560.4.3	400-50	0,75	2,1	1440	59,5	65	-20/40	67
BEAR 560EX-TAA4U-4T0,75	560.4.4	400-50	0,75	2,1	1440	60	65	-20/40	67
BEAR 560EX-TAA5U-4T1,1	560.4.5	400-50	1,1	3,1	1440	59,7	65	-20/40	71
BEAR 560EX-TAA6U-4T0,37	560.4.6	400-50	0,37	1,15	1440	60,3	65	-20/40	60
BEAR 560EX-TAA7U-4T0,75	560.4.7	400-50	0,75	2,1	1440	59,8	65	-20/40	68
BEAR 560EX-TAA8U-4T1,1	560.4.8	400-50	1,1	3,1	1440	58,8	65	-20/40	72
BEAR 560EX-TAA9U-4T1,1	560.4.9	400-50	1,1	3,1	1440	59,3	65	-20/40	72
BEAR 560EX-TAA10U-4T1,5	560.4.10	400-50	1,5	3,6	1440	60,2	65	-20/40	76
BEAR 630EX-TAA1U-4T0,55	630.4.1	400-50	0,55	1,6	1440	60,4	65	-20/40	65
BEAR 630EX-TAA2U-4T0,55	630.4.2	400-50	0,55	1,6	1440	60	65	-20/40	65
BEAR 630EX-TAA3U-4T0,75	630.4.3	400-50	0,75	2,1	1440	58,2	65	-20/40	73
BEAR 630EX-TAA4U-4T1,1	630.4.4	400-50	1,1	3,1	1440	61,6	65	-20/40	76
BEAR 630EX-TAA5U-4T1,5	630.4.5	400-50	1,5	3,6	1440	62,4	65	-20/40	80
BEAR 630EX-TAA6U-4T0,75	630.4.6	400-50	0,75	2,1	1440	61,2	65	-20/40	72
BEAR 630EX-TAA7U-4T2,2	630.4.7	400-50	2,2	5,4	1440	65,1	65	-20/40	97
BEAR 630EX-TAA8U-4T0,75	630.4.8	400-50	0,75	2,1	1440	61,8	65	-20/40	73
BEAR 630EX-TAA9U-4T0,75	630.4.9	400-50	0,75	2,1	1440	67	65	-20/40	73
BEAR 630EX-TAA10U-4T1,1	630.4.10	400-50	1,1	3,1	1440	60,5	65	-20/40	76
BEAR 630EX-TAA11U-4T1,5	630.4.11	400-50	1,5	3,6	1440	60,4	65	-20/40	80
BEAR 630EX-TAA12U-4T1,5	630.4.12	400-50	1,5	3,6	1440	61	65	-20/40	80
BEAR 630EX-TAA13U-4T2,2	630.4.13	400-50	2,2	5,4	1440	62	65	-20/40	97
BEAR 630EX-TAA14U-4T2,2	630.4.14	400-50	2,2	5,4	1440	62,1	65	-20/40	98
BEAR 630EX-TAA15U-4T1,5	630.4.15	400-50	1,5	3,6	1440	65,3	65	-20/40	81
BEAR 630EX-TAA16U-4T2,2	630.4.16	400-50	2,2	5,4	1440	65,2	65	-20/40	98

MODEL	MODEL NUMBER	Voltage Frequency	Motor Power	Current	Rotation Speed	Sound Pressure	Protection Class	Working Range	Mass
		V-Hz	kW	A	RPM	Lp(A) dB at 3m	IP	°C	~ Kg
BEAR 630EX-TAA17U-4T2,2	630.4.17	400-50	2,2	5,4	1440	65,1	65	-20/40	98
BEAR 630EX-TAA18U-4T2,2	630.4.18	400-50	2,2	5,4	1440	65,4	65	-20/40	98
BEAR 630EX-TAA19U-4T3	630.4.19	400-50	3	6,9	1440	66,8	65	-20/40	106
BEAR 710EX-TAA1U-4T0,75	710.4.1	400-50	0,75	2,1	1440	65,8	65	-20/40	79
BEAR 710EX-TAA2U-4T1,5	710.4.2	400-50	1,5	3,6	1440	63	65	-20/40	86
BEAR 710EX-TAA3U-4T1,5	710.4.3	400-50	1,5	3,6	1440	65,9	65	-20/40	87
BEAR 710EX-TAA4U-4T2,2	710.4.4	400-50	2,2	5,4	1440	66	65	-20/40	104
BEAR 710EX-TAA5U-4T3	710.4.5	400-50	3	6,9	1440	66,8	65	-20/40	112
BEAR 710EX-TAA6U-4T3	710.4.6	400-50	3	6,9	1440	67,5	65	-20/40	112
BEAR 710EX-TAA7U-4T3	710.4.7	400-50	3	6,9	1440	68,1	65	-20/40	113
BEAR 710EX-TAA8U-4T1,5	710.4.8	400-50	1,5	3,6	1440	63,8	65	-20/40	89
BEAR 710EX-TAA9U-4T2,2	710.4.9	400-50	2,2	5,4	1440	62,2	65	-20/40	106
BEAR 710EX-TAA10U-4T2,2	710.4.10	400-50	2,2	5,4	1440	67,8	65	-20/40	105
BEAR 710EX-TAA11U-4T3	710.4.11	400-50	3	6,9	1440	67	65	-20/40	113
BEAR 710EX-TAA12U-4T4	710.4.12	400-50	4	8,6	1440	67,5	65	-20/40	117
BEAR 710EX-TAA13U-4T4	710.4.13	400-50	4	8,6	1440	66,5	65	-20/40	116
BEAR 710EX-TAA14U-4T5,5	710.4.14	400-50	5,5	11,8	1440	67,5	65	-20/40	149
BEAR 800EX-TAA1U-4T2,2	800.4.1	400-50	2,2	5,4	1440	70,8	65	-20/40	111
BEAR 800EX-TAA2U-4T3	800.4.2	400-50	3	6,9	1440	69	65	-20/40	120
BEAR 800EX-TAA3U-4T3	800.4.3	400-50	3	6,9	1440	68,1	65	-20/40	119
BEAR 800EX-TAA4U-4T4	800.4.4	400-50	4	8,6	1440	69,1	65	-20/40	127
BEAR 800EX-TAA5U-4T4	800.4.5	400-50	4	8,6	1440	69,3	65	-20/40	128
BEAR 800EX-TAA6U-4T4	800.4.6	400-50	4	8,6	1440	68,6	65	-20/40	127
BEAR 800EX-TAA7U-4T5,5	800.4.7	400-50	5,5	11,8	1440	70,1	65	-20/40	161
BEAR 800EX-TAA8U-4T5,5	800.4.8	400-50	5,5	11,8	1440	70,8	65	-20/40	161
BEAR 800EX-TAA9U-4T1,5	800.4.9	400-50	1,5	3,6	1440	73,2	65	-20/40	94
BEAR 800EX-TAA10U-4T3	800.4.10	400-50	3	6,9	1440	72,1	65	-20/40	120
BEAR 800EX-TAA11U-4T4	800.4.11	400-50	4	8,6	1440	70,7	65	-20/40	128
BEAR 800EX-TAA12U-4T5,5	800.4.12	400-50	5,5	11,8	1440	69,7	65	-20/40	162
BEAR 800EX-TAA13U-4T7,5	800.4.13	400-50	7,5	15,8	1440	70,7	65	-20/40	179
BEAR 800EX-TAA14U-4T2,2	800.4.14	400-50	2,2	5,4	1440	72,3	65	-20/40	113
BEAR 800EX-TAA15U-4T11	800.4.15	400-50	11	22,6	1440	71,1	65	-20/40	240
BEAR 800EX-TAA16U-4T7,5	800.4.16	400-50	7,5	15,8	1440	70,9	65	-20/40	180
BEAR 800EX-TAA17U-4T11	800.4.17	400-50	11	22,6	1440	71,4	65	-20/40	240
BEAR 800EX-TAA18U-4T4	800.4.18	400-50	4	8,6	1440	71,8	65	-20/40	135
BEAR 800EX-TAA19U-4T4	800.4.19	400-50	4	8,6	1440	72	65	-20/40	135
BEAR 800EX-TAA20U-4T5,5	800.4.20	400-50	5,5	11,8	1440	71,5	65	-20/40	168
BEAR 800EX-TAA21U-4T5,5	800.4.21	400-50	5,5	11,8	1440	70,9	65	-20/40	168
BEAR 900EX-TAA1U-4T5,5	900.4.1	400-50	5,5	11,8	1440	76,7	65	-20/40	170
BEAR 900EX-TAA2U-4T7,5	900.4.2	400-50	7,5	15,8	1440	70,5	65	-20/40	188
BEAR 900EX-TAA3U-4T4	900.4.3	400-50	4	8,6	1440	70,3	65	-20/40	138
BEAR 900EX-TAA4U-4T5,5	900.4.4	400-50	5,5	11,8	1440	70,4	65	-20/40	171
BEAR 900EX-TAA5U-4T4	900.4.5	400-50	4	8,6	1440	73,9	65	-20/40	138
BEAR 900EX-TAA6U-4T5,5	900.4.6	400-50	5,5	11,8	1440	73,1	65	-20/40	171
BEAR 900EX-TAA7U-4T7,5	900.4.7	400-50	7,5	15,8	1440	73,2	65	-20/40	189
BEAR 900EX-TAA8U-4T7,5	900.4.8	400-50	7,5	15,8	1440	71,7	65	-20/40	189

MODEL	MODEL NUMBER	Voltage Frequency	Motor Power	Current	Rotation Speed	Sound Pressure	Protection Class	Working Range	Mass
		V-Hz	kW	A	RPM	Lp(A) dB at 3m	IP	°C	~ Kg
BEAR 900EX-TAA9U-4T7,5	900.4.9	400-50	7,5	15,8	1440	72,5	65	-20/40	189
BEAR 900EX-TAA10U-4T7,5	900.4.10	400-50	7,5	15,8	1440	73,2	65	-20/40	189
BEAR 900EX-TAA11U-4T11	900.4.11	400-50	11	22,6	1440	72,8	65	-20/40	251
BEAR 900EX-TAA12U-4T11	900.4.12	400-50	11	22,6	1440	72,9	65	-20/40	251
BEAR 900EX-TAA13U-4T15	900.4.13	400-50	15	30,5	1440	72	65	-20/40	275
BEAR 900EX-TAA14U-4T7,5	900.4.14	400-50	7,5	15,8	1440	73,1	65	-20/40	190
BEAR 900EX-TAA15U-4T7,5	900.4.15	400-50	7,5	15,8	1440	75,9	65	-20/40	190
BEAR 900EX-TAA16U-4T11	900.4.16	400-50	11	22,6	1440	77,8	65	-20/40	252
BEAR 900EX-TAA17U-4T15	900.4.17	400-50	15	30,5	1440	73,7	65	-20/40	277
BEAR 900EX-TAA18U-4T15	900.4.18	400-50	15	30,5	1440	73,5	65	-20/40	277
BEAR 900EX-TAA19U-4T15	900.4.19	400-50	15	30,5	1440	74,3	65	-20/40	277
BEAR 900EX-TAA20U-4T11	900.4.20	400-50	11	22,6	1440	73,4	65	-20/40	257
BEAR 900EX-TAA21U-4T11	900.4.21	400-50	11	22,6	1440	73,4	65	-20/40	257
BEAR 900EX-TAA22U-4T15	900.4.22	400-50	15	30,5	1440	71,6	65	-20/40	281
BEAR 1000EX-TAA1U-4T3	1000.4.1	400-50	3	6,9	1440	70,1	65	-20/40	157
BEAR 1000EX-TAA2U-4T3	1000.4.2	400-50	3	6,9	1440	71	65	-20/40	157
BEAR 1000EX-TAA3U-4T4	1000.4.3	400-50	4	8,6	1440	71,7	65	-20/40	170
BEAR 1000EX-TAA4U-4T4	1000.4.4	400-50	4	8,6	1440	72,5	65	-20/40	170
BEAR 1000EX-TAA5U-4T5,5	1000.4.5	400-50	5,5	11,8	1440	72,4	65	-20/40	210
BEAR 1000EX-TAA6U-4T7,5	1000.4.6	400-50	7,5	15,8	1440	75,7	65	-20/40	227
BEAR 1000EX-TAA7U-4T11	1000.4.7	400-50	11	22,6	1440	77,4	65	-20/40	311
BEAR 1000EX-TAA8U-4T5,5	1000.4.8	400-50	5,5	11,8	1440	71,8	65	-20/40	211
BEAR 1000EX-TAA9U-4T7,5	1000.4.9	400-50	7,5	15,8	1440	73,3	65	-20/40	228
BEAR 1000EX-TAA10U-4T5,5	1000.4.10	400-50	5,5	11,8	1440	74,9	65	-20/40	212
BEAR 1000EX-TAA11U-4T7,5	1000.4.11	400-50	7,5	15,8	1440	78	65	-20/40	229
BEAR 1000EX-TAA12U-4T11	1000.4.12	400-50	11	22,6	1440	76	65	-20/40	311
BEAR 1000EX-TAA13U-4T11	1000.4.13	400-50	11	22,6	1440	76,4	65	-20/40	311
BEAR 1000EX-TAA14U-4T15	1000.4.14	400-50	15	30,5	1440	77,8	65	-20/40	335
BEAR 1000EX-TAA15U-4T15	1000.4.15	400-50	15	30,5	1440	78,4	65	-20/40	335
BEAR 1000EX-TAA16U-4T7,5	1000.4.16	400-50	7,5	15,8	1440	75,7	65	-20/40	222
BEAR 1000EX-TAA17U-4T7,5	1000.4.17	400-50	7,5	15,8	1440	75,3	65	-20/40	222
BEAR 1000EX-TAA18U-4T11	1000.4.18	400-50	11	22,6	1440	75,3	65	-20/40	304
BEAR 1000EX-TAA19U-4T11	1000.4.19	400-50	11	22,6	1440	76	65	-20/40	304
BEAR 1000EX-TAA20U-4T11	1000.4.20	400-50	11	22,6	1440	80,5	65	-20/40	311
BEAR 1000EX-TAA21U-4T11	1000.4.21	400-50	11	22,6	1440	80,5	65	-20/40	311
BEAR 1000EX-TAA22U-4T15	1000.4.22	400-50	15	30,5	1440	79,5	65	-20/40	335
BEAR 1000EX-TAA23U-4T15	1000.4.23	400-50	15	30,5	1440	78,4	65	-20/40	335
BEAR 1000EX-TAA24U-4T22	1000.4.24	400-50	22	22	1440	79,5	65	-20/40	448
BEAR 1000EX-TAA25.AU-4T11	1000.4.25.A	400-50	11	22,6	1440	73,3	65	-20/40	315
BEAR 1000EX-TAA25.BU-4T15	1000.4.25.B	400-50	15	30,5	1440	73,3	65	-20/40	339
BEAR 1000EX-TAA26U-4T15	1000.4.26	400-50	15	30,5	1440	75	65	-20/40	339
BEAR 1000EX-TAA27U-4T22	1000.4.27	400-50	22	22	1440	76,4	65	-20/40	452
BEAR 1000EX-TAA28U-4T30	1000.4.28	400-50	30	57	1440	79,1	65	-20/40	518
BEAR 1000EX-TAA29U-4T22	1000.4.29	400-50	22	22	1440	77,5	65	-20/40	452
BEAR 1000EX-TAA30U-4T30	1000.4.30	400-50	30	57	1440	77,8	65	-20/40	525
BEAR 1000EX-TAA31U-4T7,5	1000.4.31	400-50	7,5	15,8	1440	78,8	65	-20/40	223

MODEL	MODEL NUMBER	Voltage Frequency	Motor Power	Current	Rotation Speed	Sound Pressure	Protection Class	Working Range	Mass
		V-Hz	kW	A	RPM	Lp(A) dB at 3m	IP	°C	~ Kg
BEAR 1000EX-TAA32U-4T11	1000.4.32	400-50	11	22,6	1440	75,9	65	-20/40	305
BEAR 1000EX-TAA33U-4T15	1000.4.33	400-50	15	30,5	1440	75,4	65	-20/40	329
BEAR 1000EX-TAA34U-4T22	1000.4.34	400-50	22	22	1440	82,5	65	-20/40	448
BEAR 1000EX-TAA35U-4T22	1000.4.35	400-50	22	22	1440	82,5	65	-20/40	448
BEAR 1000EX-TAA36U-4T30	1000.4.36	400-50	30	57	1440	81,5	65	-20/40	521
BEAR 1000EX-TAA37U-4T37	1000.4.37	400-50	37	70	1440	80,5	65	-20/40	565
BEAR 1120EX-TAA1U-4T5,5	1120.4.1	400-50	5,5	11,8	1440	75,5	65	-20/40	235
BEAR 1120EX-TAA2U-4T7,5	1120.4.2	400-50	7,5	15,8	1440	76,1	65	-20/40	253
BEAR 1120EX-TAA3U-4T11	1120.4.3	400-50	11	22,6	1440	77,6	65	-20/40	321
BEAR 1120EX-TAA4U-4T11	1120.4.4	400-50	11	22,6	1440	77,8	65	-20/40	319
BEAR 1120EX-TAA5U-4T15	1120.4.5	400-50	15	30,5	1440	79,1	65	-20/40	345
BEAR 1120EX-TAA6U-4T18,5	1120.4.6	400-50	18,5	38	1440	80,5	65	-20/40	432
BEAR 1120EX-TAA7U-4T7,5	1120.4.7	400-50	7,5	15,8	1440	77,1	65	-20/40	255
BEAR 1120EX-TAA8U-4T11	1120.4.8	400-50	11	22,6	1440	80,5	65	-20/40	321
BEAR 1120EX-TAA9U-4T11	1120.4.9	400-50	11	22,6	1440	79,5	65	-20/40	321
BEAR 1120EX-TAA10U-4T15	1120.4.10	400-50	15	30,5	1440	78,3	65	-20/40	345
BEAR 1120EX-TAA11U-4T15	1120.4.11	400-50	15	30,5	1440	77,8	65	-20/40	345
BEAR 1120EX-TAA12U-4T18,5	1120.4.12	400-50	18,5	38	1440	79,5	65	-20/40	432
BEAR 1120EX-TAA13U-4T22	1120.4.13	400-50	22	22	1440	80,5	65	-20/40	458
BEAR 1120EX-TAA14U-4T22	1120.4.14	400-50	22	22	1440	81,5	65	-20/40	458
BEAR 1120EX-TAA15U-4T22	1120.4.15	400-50	22	22	1440	80,5	65	-20/40	458
BEAR 1120EX-TAA16U-4T11	1120.4.16	400-50	11	22,6	1440	82,5	65	-20/40	321
BEAR 1120EX-TAA17U-4T15	1120.4.17	400-50	15	30,5	1440	82,5	65	-20/40	345
BEAR 1120EX-TAA18U-4T15	1120.4.18	400-50	15	30,5	1440	82,5	65	-20/40	345
BEAR 1120EX-TAA19U-4T22	1120.4.19	400-50	22	22	1440	80,5	65	-20/40	458
BEAR 1120EX-TAA20U-4T30	1120.4.20	400-50	30	57	1440	83,5	65	-20/40	547
BEAR 1120EX-TAA21U-4T5,5	1120.4.21	400-50	5,5	11,8	1440	83,5	65	-20/40	232
BEAR 1120EX-TAA22U-4T7,5	1120.4.22	400-50	7,5	15,8	1440	83,5	65	-20/40	249
BEAR 1120EX-TAA23U-4T11	1120.4.23	400-50	11	22,6	1440	79,1	65	-20/40	316
BEAR 1120EX-TAA24U-4T15	1120.4.24	400-50	15	30,5	1440	78,6	65	-20/40	340
BEAR 1120EX-TAA25U-4T18,5	1120.4.25	400-50	18,5	38	1440	77,6	65	-20/40	427
BEAR 1120EX-TAA26U-4T11	1120.4.26	400-50	11	22,6	1440	83,5	65	-20/40	325
BEAR 1120EX-TAA27U-4T15	1120.4.27	400-50	15	30,5	1440	83,5	65	-20/40	349
BEAR 1120EX-TAA28U-4T15	1120.4.28	400-50	15	30,5	1440	82,5	65	-20/40	349
BEAR 1120EX-TAA29U-4T18,5	1120.4.29	400-50	18,5	38	1440	81,5	65	-20/40	436
BEAR 1120EX-TAA30U-4T18,5	1120.4.30	400-50	18,5	38	1440	81,5	65	-20/40	436
BEAR 1120EX-TAA31U-4T22	1120.4.31	400-50	22	22	1440	81,5	65	-20/40	462
BEAR 1120EX-TAA32U-4T30	1120.4.32	400-50	30	57	1440	80,5	65	-20/40	551
BEAR 1120EX-TAA33U-4T37	1120.4.33	400-50	37	70	1440	80,5	65	-20/40	595
BEAR 1120EX-TAA34U-4T22	1120.4.34	400-50	22	22	1440	82,5	65	-20/40	473
BEAR 1120EX-TAA35U-4T30	1120.4.35	400-50	30	57	1440	81,5	65	-20/40	547
BEAR 1120EX-TAA36U-4T15	1120.4.36	400-50	15	30,5	1440	84,5	65	-20/40	354
BEAR 1120EX-TAA37U-4T22	1120.4.37	400-50	22	22	1440	81,5	65	-20/40	467
BEAR 1120EX-TAA38U-4T45	1120.4.38	400-50	45	84	1440	81,5	65	-20/40	629
BEAR 1120EX-TAA39U-4T22	1120.4.39	400-50	22	22	1440	77,1	65	-20/40	454
BEAR 1120EX-TAA40U-4T30	1120.4.40	400-50	30	57	1440	78,1	65	-20/40	543

MODEL	MODEL NUMBER	Voltage Frequency	Motor Power	Current	Rotation Speed	Sound Pressure	Protection Class	Working Range	Mass
		V-Hz	kW	A	RPM	Lp(A) dB at 3m	IP	°C	~ Kg
BEAR 1250EX-TAA1U-4T11	1250.4.1	400-50	11	22,6	1440	83,5	65	-20/40	342
BEAR 1250EX-TAA2U-4T15	1250.4.2	400-50	15	30,5	1440	82,5	65	-20/40	366
BEAR 1250EX-TAA3U-4T18,5	1250.4.3	400-50	18,5	38	1440	82,5	65	-20/40	452
BEAR 1250EX-TAA4U-4T18,5	1250.4.4	400-50	18,5	38	1440	82,5	65	-20/40	452
BEAR 1250EX-TAA5U-4T22	1250.4.5	400-50	22	22	1440	82,5	65	-20/40	478
BEAR 1250EX-TAA6U-4T11	1250.4.6	400-50	11	22,6	1440	87,5	65	-20/40	342
BEAR 1250EX-TAA7U-4T18,5	1250.4.7	400-50	18,5	38	1440	88,5	65	-20/40	452
BEAR 1250EX-TAA8U-4T22	1250.4.8	400-50	22	22	1440	88,5	65	-20/40	478
BEAR 1250EX-TAA9U-4T22	1250.4.9	400-50	22	22	1440	88,5	65	-20/40	478
BEAR 1250EX-TAA10U-4T22	1250.4.10	400-50	22	22	1440	88,5	65	-20/40	478
BEAR 1250EX-TAA11U-4T30	1250.4.11	400-50	30	57	1440	86,5	65	-20/40	577
BEAR 1250EX-TAA12U-4T30	1250.4.12	400-50	30	57	1440	87,5	65	-20/40	577
BEAR 1250EX-TAA13U-4T30	1250.4.13	400-50	30	57	1440	81,5	65	-20/40	577
BEAR 1250EX-TAA14U-4T30	1250.4.14	400-50	30	57	1440	87,5	65	-20/40	577
BEAR 1250EX-TAA15U-4T30	1250.4.15	400-50	30	57	1440	82,5	65	-20/40	577
BEAR 1250EX-TAA16U-4T30	1250.4.16	400-50	30	57	1440	83,5	65	-20/40	577
BEAR 1250EX-TAA17U-4T37	1250.4.17	400-50	37	70	1440	83,5	65	-20/40	621
BEAR 1250EX-TAA18U-4T37	1250.4.18	400-50	37	70	1440	83,5	65	-20/40	621
BEAR 1250EX-TAA19U-4T37	1250.4.19	400-50	37	70	1440	83,5	65	-20/40	621
BEAR 1250EX-TAA20U-4T45	1250.4.20	400-50	45	84	1440	83,5	65	-20/40	651
BEAR 1250EX-TAA21U-4T45	1250.4.21	400-50	45	84	1440	83,5	65	-20/40	651
BEAR 1250EX-TAA22U-4T45	1250.4.22	400-50	45	84	1440	83,5	65	-20/40	651
BEAR 1250EX-TAA23U-4T45	1250.4.23	400-50	45	84	1440	41,5	65	-20/40	651
BEAR 1250EX-TAA24U-4T45	1250.4.24	400-50	45	84	1440	84,5	65	-20/40	651
BEAR 1250EX-TAA25U-4T55	1250.4.25	400-50	55	102	1440	85,5	65	-20/40	722
BEAR 1250EX-TAA26U-4T55	1250.4.26	400-50	55	102	1440	85,5	65	-20/40	722
BEAR 1250EX-TAA27U-4T55	1250.4.27	400-50	55	102	1440	85,5	65	-20/40	722
BEAR 1250EX-TAA28U-4T22	1250.4.28	400-50	22	22	1440	88,5	65	-20/40	478
BEAR 1250EX-TAA29.AU-4T22	1250.4.29.A	400-50	22	22	1440	88,5	65	-20/40	478
BEAR 1250EX-TAA29.BU-4T30	1250.4.29.B	400-50	30	57	1440	88,5	65	-20/40	577
BEAR 1250EX-TAA30U-4T30	1250.4.30	400-50	30	57	1440	86,5	65	-20/40	577
BEAR 1250EX-TAA31U-4T30	1250.4.31	400-50	30	57	1440	86,5	65	-20/40	577
BEAR 1250EX-TAA32U-4T45	1250.4.32	400-50	45	84	1440	84,5	65	-20/40	651
BEAR 1250EX-TAA33U-4T55	1250.4.33	400-50	55	102	1440	83,5	65	-20/40	722
BEAR 1250EX-TAA34U-4T55	1250.4.34	400-50	55	102	1440	83,5	65	-20/40	722
BEAR 1250EX-TAA35U-4T55	1250.4.35	400-50	55	102	1440	83,5	65	-20/40	722
BEAR 1250EX-TAA36U-4T11	1250.4.36	400-50	11	22,6	1440	76,5	65	-20/40	347
BEAR 1250EX-TAA37U-4T18,5	1250.4.37	400-50	18,5	38	1440	78,8	65	-20/40	457
BEAR 1250EX-TAA38U-4T22	1250.4.38	400-50	22	22	1440	79,4	65	-20/40	483
BEAR 1250EX-TAA39U-4T30	1250.4.39	400-50	30	57	1440	84,5	65	-20/40	582
BEAR 1250EX-TAA40U-4T30	1250.4.40	400-50	30	57	1440	85,5	65	-20/40	582
BEAR 1250EX-TAA41U-4T37	1250.4.41	400-50	37	70	1440	82,5	65	-20/40	626
BEAR 1250EX-TAA42U-4T37	1250.4.42	400-50	37	70	1440	83,5	65	-20/40	626

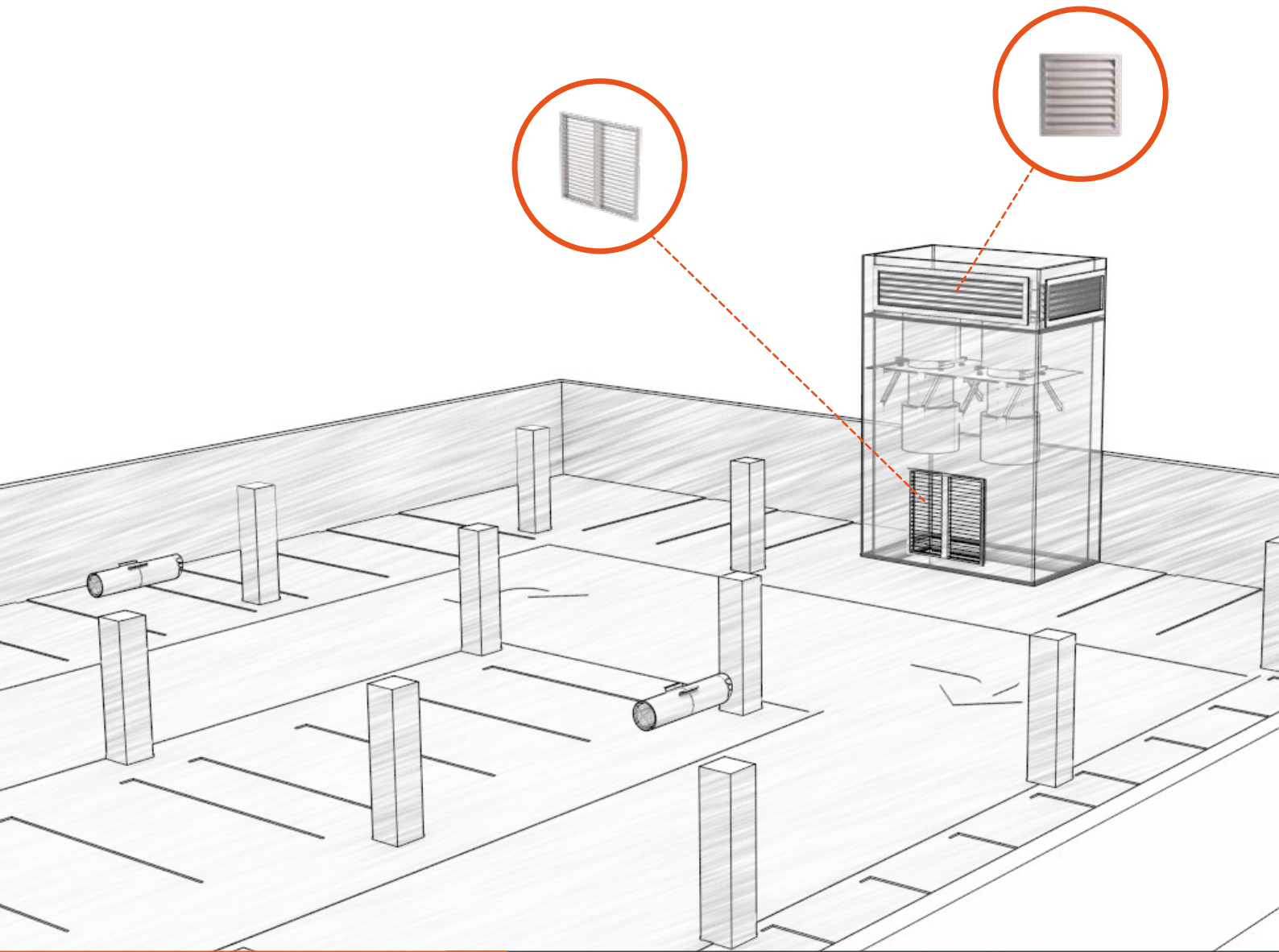

Hound
Dampers

SMOKE EVACUATION DAMPERS



- Frame and blades are made of 1,2 mm galvanized sheet
- The blades are on a steel shaft in bronze bearings that do not require lubrication. works in parallel motion
- The case is standard with flanges for wall or channel mounting
- Sealing grade is according to EN17051 Class-C
- Produced with servo motor that can be connected to 24 Volt automation

PRODUCT DIMENSIONS

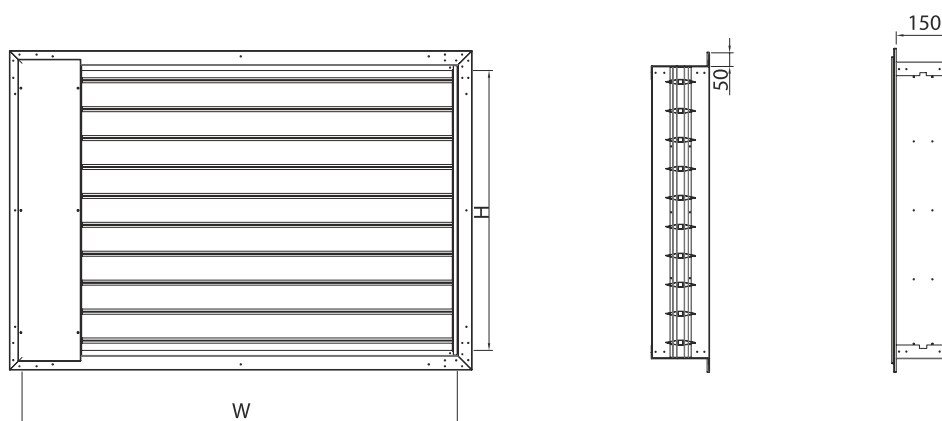

MODEL	Width	Height
	mm	mm
HOUND SD M24 SW800X800	800	800
HOUND SD M24 SW900X900	900	900
HOUND SD M24 SW1000X1000	1000	1000
HOUND SD M24 SW1100X1100	1100	1100
HOUND SD M24 SW1200X1200	1200	1200
HOUND SD M24 SW1300X1300	1300	1300
HOUND SD M24 SW1400X1400	1400	1400
HOUND SD M24 SW1500X1500	1500	1500
HOUND SD M24 SW1600X1600	1600	1600
HOUND SD M24 SW1700X1700	1700	1700
HOUND SD M24 SW1800X1800	1800	1800
HOUND SD M24 SW1900X1900	1900	1900
HOUND SD M24 SW2000X2000	2000	2000
HOUND SD M24 SW2100X2100	2100	2100
HOUND SD M24 SW2200X2200	2200	2200

AIR LOUVRE



- Frame and blades are manufactured from extruded aluminum profile.
- Suitable for outdoor use
- Electrostatic powder coated with color code RAL9016

PRODUCT DIMENSIONS

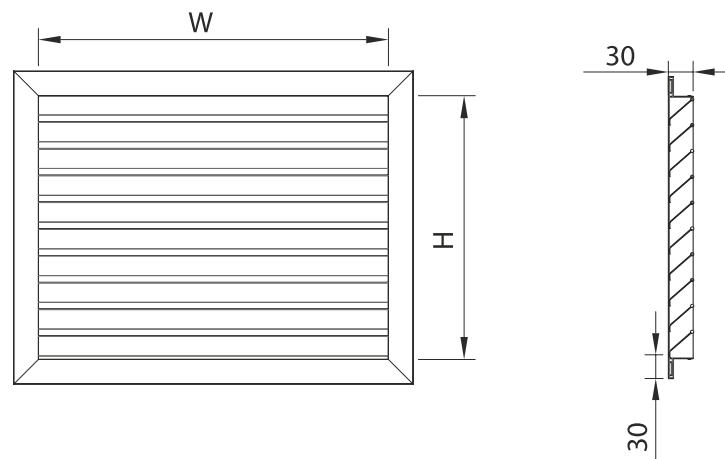

MODEL	Width	Height
	mm	mm
HOUND AL 800X800	800	800
HOUND AL 900X900	900	900
HOUND AL 1000X1000	1000	1000
HOUND AL 1100X1100	1100	1100
HOUND AL 1200X1200	1200	1200
HOUND AL 1300X1300	1300	1300
HOUND AL 1400X1400	1400	1400
HOUND AL 1500X1500	1500	1500
HOUND AL 1600X1600	1600	1600
HOUND AL 1700X1700	1700	1700
HOUND AL 1800X1800	1800	1800
HOUND AL 1900X1900	1900	1900
HOUND AL 2000X2000	2000	2000
HOUND AL 2100X2100	2100	2100
HOUND AL 2200X2200	2200	2200

PRESURE RELIEF DAMPERS



- Frame and blades are made of galvanized sheet, wing bearings are made of bronze material
- When the targeted pressure value is exceeded, the wings open and system security is provided
- Easily mounted to the air duct by means of bolts - nuts and duct clips

PRODUCT DIMENSIONS

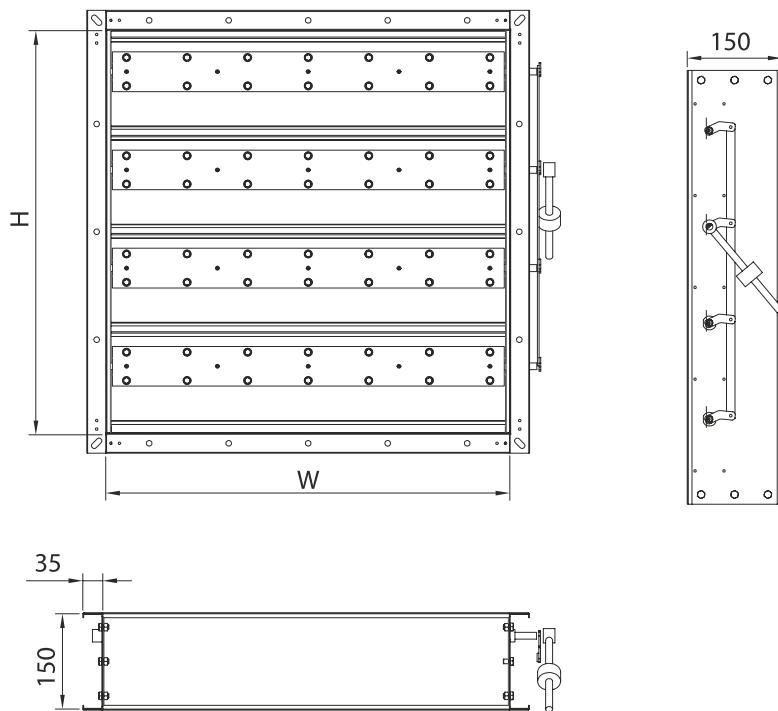

MODEL	Width	Height
	mm	mm
HOUD CRD D200X200	200	200
HOUD CRD D300X300	300	300
HOUD CRD D400X400	400	400
HOUD CRD D500X500	500	500

FIRE DAMPERS



- The casing and the blade are made of 1,2 mm galvanized sheet, between the blade walls 70
- 25 mm thick fire resistant rock wool is used in kg/m3 density.
- There is a protection fuse that reacts to 72 C temperature.
- High temperature resistant red silicone insulation for sealing
- Servo motor that can be connected to 230 or 24 Volt automation as an option
Producible

PRODUCT DIMENSIONS

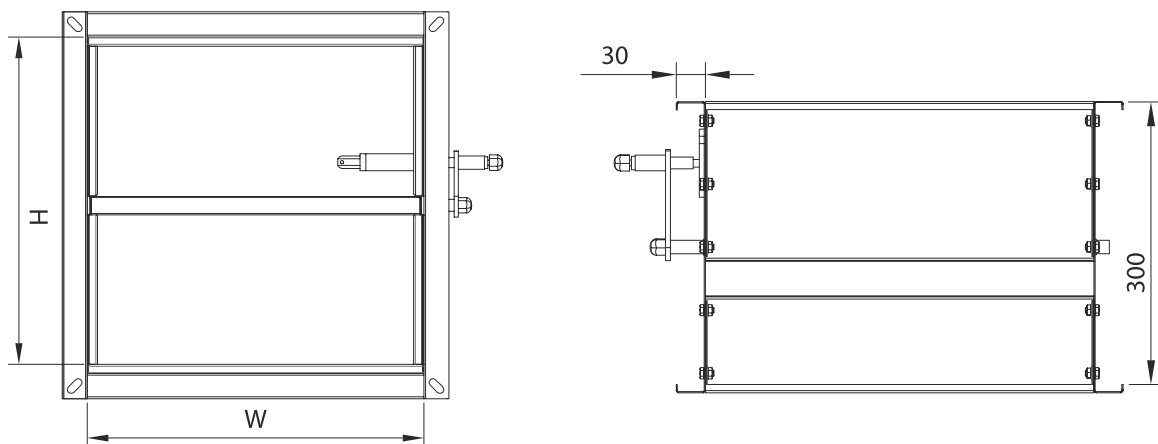

MODEL	Width	Height
	mm	mm
HOUND FD D300X150	300	150
HOUND FD D400X200	400	200
HOUND FD D500X300	500	300
HOUND FD D600X400	600	400

RECTANGULAR FAN DAMPERS WITH SERVOMOTOR



- Frame and blades are made of 1,2 mm galvanized sheet
- Blades are made of lubrication-free bronze on a steel shaft
- Runs in parallel motion inside beds
- The case is standard with flange for wall or duct mounting.
- Sealing grade according to EN17051 Class-C
- Produced with servo motor that can be connected to 24 Volt automation

Return Air Control Dampers With Servomotor	
MODEL	RELATED PRODUCT
HOUND SD M24 F500	DF500, M500
HOUND SD M24 F560	DF560, M560
HOUND SD M24 F630	DF630, M630
HOUND SD M24 F710	DF710, M710
HOUND SD M24 F800	DF800, M800
HOUND SD M24 F900	DF900, M900
HOUND SD M24 F1000	DF1000, M1000
HOUND SD M24 F1120	DF1120, M1120
HOUND SD M24 F1250	DF1250, M1250

RECTANGULAR RETURN AIR CONTROL DAMPERS



- Frame and blades are made of 1,2 mm galvanized sheet
- Blades are made of lubrication-free bronze on a steel shaft
- Runs in parallel motion inside beds
- The case is standard with flange for wall or duct mounting
- Sealing grade according to EN17051 Class-C
- Produced with servo motor that can be connected to 24 Volt automation

Return Air Control Dampers	
MODEL	RELATED PRODUCT
HOUND SD F500	DF500, M500
HOUND SD F560	DF560, M560
HOUND SD F630	DF630, M630
HOUND SD F710	DF710, M710
HOUND SD F800	DF800, M800
HOUND SD F900	DF900, M900
HOUND SD F1000	DF1000, M1000
HOUND SD F1120	DF1120, M1120
HOUND SD F1250	DF1250, M1250

DUCT TYPE AIR DAMPERS



- Air volume control dampers with manual balancing mechanism, self-regulating mechanical control system.

PRODUCT DIMENSIONS

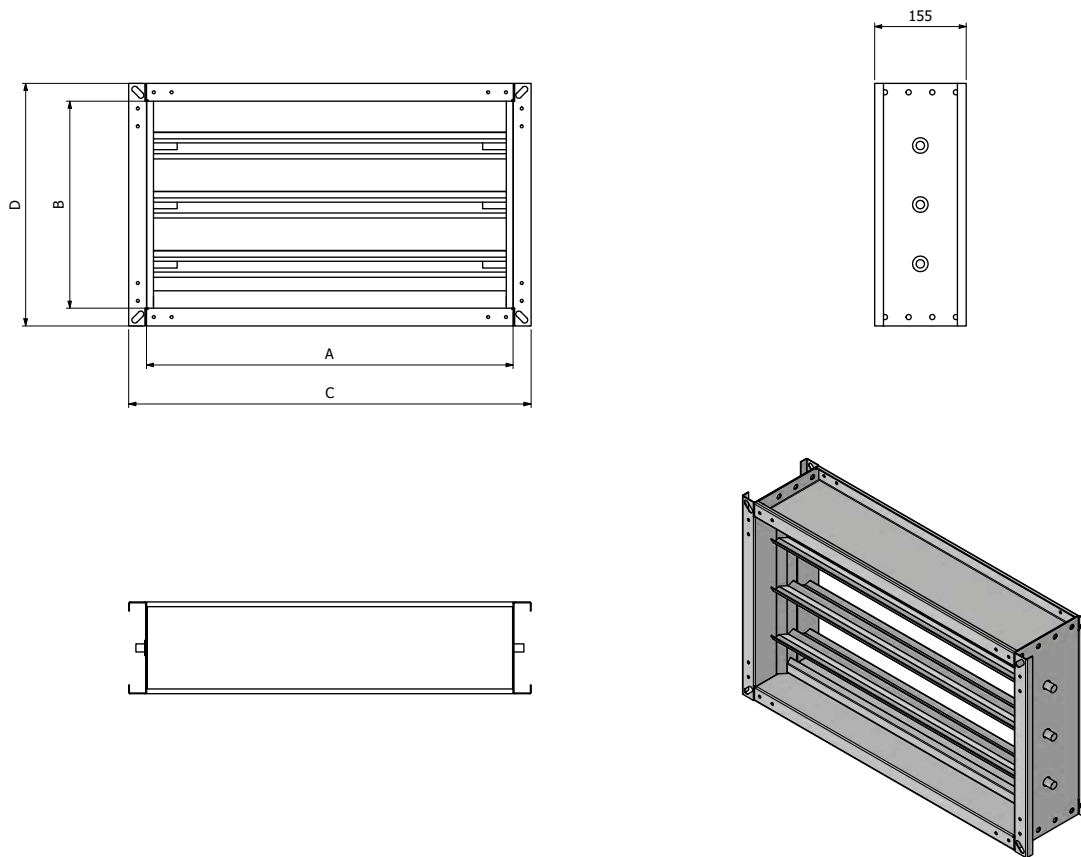

MODEL	Width	Height
	mm	mm
HOUND FD D300X150	300	150
HOUND FD D400X200	400	200
HOUND FD D500X300	500	300
HOUND FD D600X400	600	400

CIRCULAR FAN DAMPERS WITH SERVOMOTOR



- Is equipped with servo motor 12-24V and consists of galvanized steel or Aluminium depend on construction or size of product. Dampers can be linked to product control system or BMS system on demand. Purpose of use are; safety, outdoor conditions and other system requirements.

PRODUCT DIMENSIONS

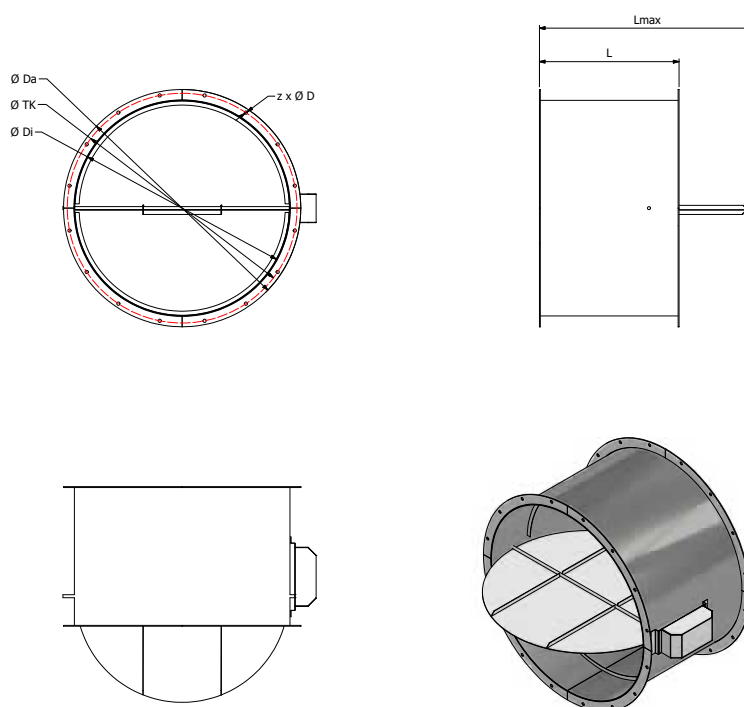

MODEL	$\varnothing Di$	$\varnothing TK$	$\varnothing Da$	L	$z \times \varnothing D$
HOUND SBD M24 F315	315	355	395	255	8 x 10
HOUND SBD M24 F355	355	395	435	285	8 x 10
HOUND SBD M24 F400	400	450	480	315	8 x 12
HOUND SBD M24 F450	450	500	530	355	8 x 12
HOUND SBD M24 F500	500	560	590	390	12 x 12
HOUND SBD M24 F560	560	620	650	435	12 x 12
HOUND SBD M24 F630	630	690	720	490	12 x 12
HOUND SBD M24 F710	710	770	800	550	16 x 12
HOUND SBD M24 F800	800	860	890	615	16 x 12
HOUND SBD M24 F900	900	970	1005	690	16 x 15
HOUND SBD M24 F1000	1000	1070	1105	765	16 x 15
HOUND SBD M24 F1120	1120	1190	1260	855	20 x 15
HOUND SBD M24 F1250	1250	1320	1390	955	20 x 15
HOUND SBD M24 F1400	1400	1470	1540	1065	20 x 15

CIRCULAR RETURN AIR CONTROL DAMPERS



- Butterfly's back-draft shutter damper and casing are manufactured from galvanized steel or Aluminium depend on construction or size of product. No welding inside. The steel spring allows the damper to be close when the fan turned off.

PRODUCT DIMENSIONS

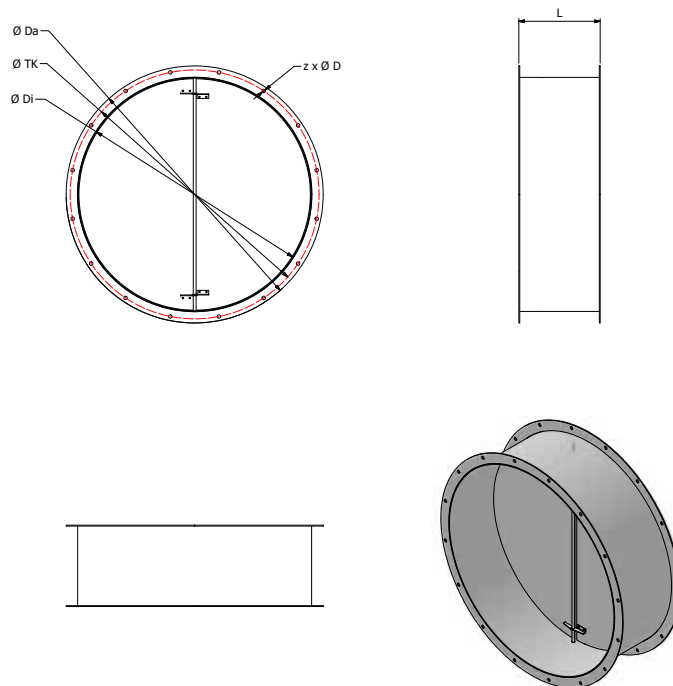

MODEL	ØDi	ØTK	ØDa	L	z x ØD
HOUND SBD F315	315	355	395	250	8 x 10
HOUND SBD F355	355	395	435	250	8 x 10
HOUND SBD F400	400	450	480	250	8 x 12
HOUND SBD F450	450	500	530	250	8 x 12
HOUND SBD F500	500	560	590	250	12 x 12
HOUND SBD F560	560	620	650	250	12 x 12
HOUND SBD F630	630	690	720	250	12 x 12
HOUND SBD F710	710	770	800	350	16 x 12
HOUND SBD F800	800	860	890	350	16 x 12
HOUND SBD F900	900	970	1005	350	16 x 15
HOUND SBD F1000	1000	1070	1105	350	16 x 15
HOUND SBD F1120	1120	1190	1260	350	20 x 15
HOUND SBD F1250	1250	1320	1390	400	20 x 15
HOUND SBD F1400	1400	1470	1540	400	20 x 15

ROOF CIRCULAR FAN DAMPERS WITH SERVOMOTOR



- Roof type butterfly is equipped with servo motor 12-24V and consists of galvanized steel or Aluminium depend on construction or size of product. Dampers can be linked to product control system or BMS system on demand. Purpose of use are; safety, outdoor conditions and other system requirements.

PRODUCT DIMENSIONS

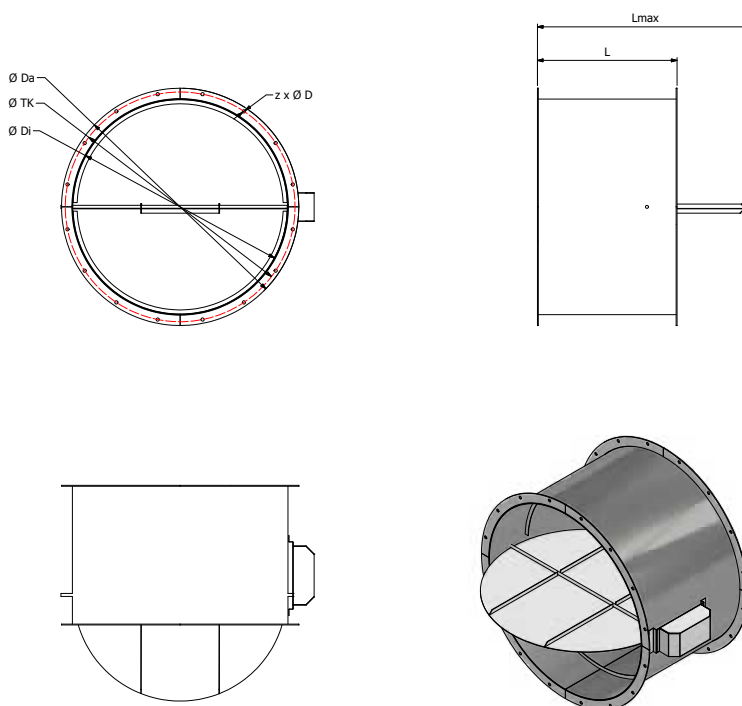

MODEL	$\varnothing Di$	$\varnothing TK$	$\varnothing Da$	L	$z \times \varnothing D$
HOUND SBD RF M24 190	200	240	280	250	6x $\varnothing 8$
HOUND SBD RF M24 225	200	240	280	250	6x $\varnothing 8$
HOUND SBD RF M24 250	230	270	310	250	6x $\varnothing 8$
HOUND SBD RF M24 280	230	270	310	250	6x $\varnothing 8$
HOUND SBD RF M24 355	260	300	340	250	6x $\varnothing 10$
HOUND SBD RF M24 400	260	300	340	250	6x $\varnothing 10$
HOUND SBD RF M24 450	260	300	340	250	6x $\varnothing 10$
HOUND SBD RF M24 500	260	300	340	250	6x $\varnothing 10$

ROOF CIRCULAR RETURN AIR CONTROL DAMPERS



- Butterfly's back-draft shutter damper and casing are manufactured from galvanized steel or Aluminium depend on construction or size of product. No welding inside. The steel spring allows the damper to be close when the fan turned off.

PRODUCT DIMENSIONS

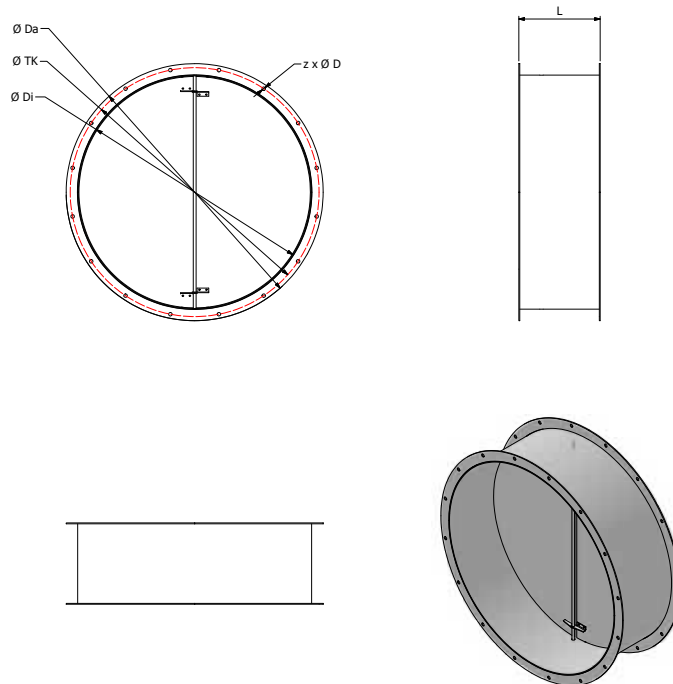

MODEL	ØDi	ØTK	ØDa	L	z x ØD
HOUND SBD RF190	200	240	280	165	6xØ8
HOUND SBD RF225	200	240	280	165	6xØ8
HOUND SBD RF250	230	270	310	190	6xØ8
HOUND SBD RF280	230	270	310	190	6xØ8
HOUND SBD RF355	260	300	340	210	6xØ10
HOUND SBD RF400	260	300	340	210	6xØ10
HOUND SBD RF450	260	300	340	210	6xØ10
HOUND SBD RF500	260	300	340	210	6xØ10

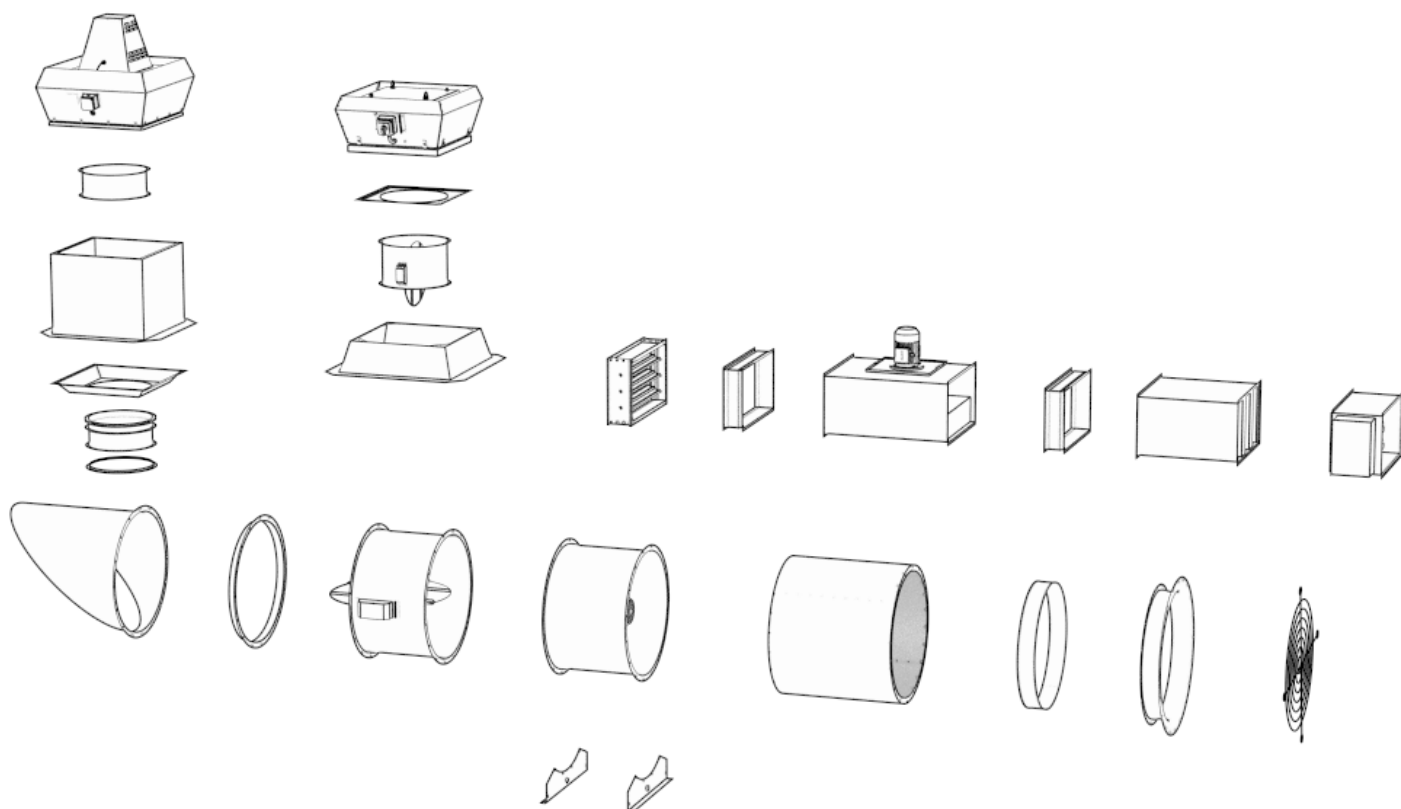

AUXILIARY EQUIPMENT - AXIAL TUBE INSPECTION DOOR



- Maintenance purpose of Fan and made of same material of fan casing.

MODEL	RELATED PRODUCT
AEIH400	DF400, M400
AEIH450	DF450, M450
AEIH500	DF500, M500
AEIH560	DF560, M560
AEIH630	DF630, M630
AEIH710	DF710, M710
AEIH800	DF800, M800
AEIH900	DF900, M900
AEIH1000	DF1000, M1000
AEIH1120	DF1120, M1120
AEIH1250	DF1250, M1250

AUXILIARY EQUIPMENT - SPRING VIBRATION ISOLATOR



- To be used for absorbing minimal vibration power on product to secure system application.

PRODUCT DIMENSIONS

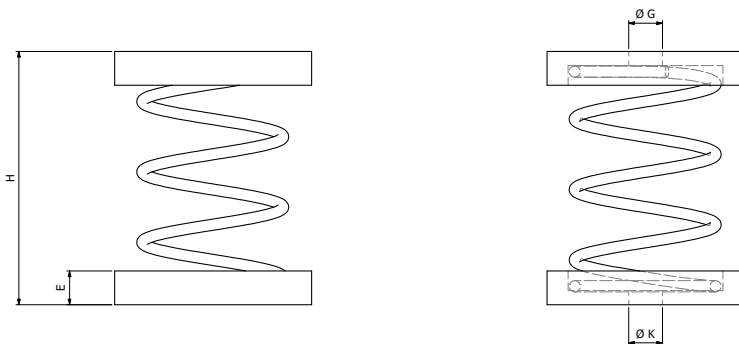

MODEL	PRODUCT WEIGHT	H	E	ØG	ØK
AE T3 OSI01	10-22 Kg	60	12	M8	M8
AE T3 OSI02	22-50 Kg	60	12	M8	M8
AE T3 OSI03	50-80 Kg	60	12	M8	M8
AE T3 OSI04	80-105 Kg	94	12	M10	M10
AE T3 OSI05	105-200 Kg	94	12	M10	M10

AUXILIARY EQUIPMENT - SUPPORT FEET



- Stand and install the fan to project and made by same material of fan casing or electrostatic powder coated steel.

PRODUCT DIMENSIONS

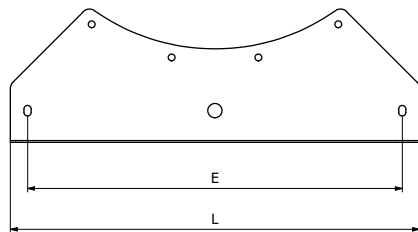

MODEL	RELATED PRODUCT	E	L
AE SF315	DF315, M315	260	315
AE SF355	DF355, M355	300	355
AE SF400	DF400, M400	345	400
AE SF450	DF450, M450	395	450
AE SF500	DF500, M500	440	500
AE SF560	DF560, M560	500	560
AE SF630	DF630, M630	570	630
AE SF710	DF710, M710	650	710
AE SF800	DF800, M800	730	800
AE SF900	DF900, M900	830	900
AE SF1000	DF1000, M1000	930	1000
AE SF1120	DF1120, M1120	1020	1120
AE SF1250	DF1250, M1250	1150	1250
AE SF1400	DF1400, M1400	1300	1400

AUXILIARY EQUIPMENT - GRILLE GUARD

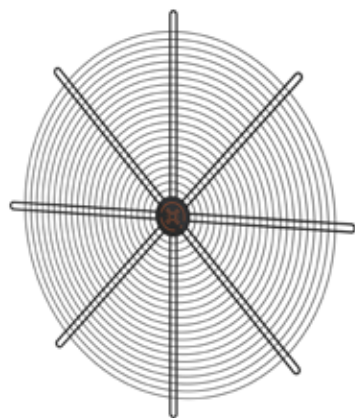

- Protection guard for suction side cover made of steel.

PRODUCT DIMENSIONS

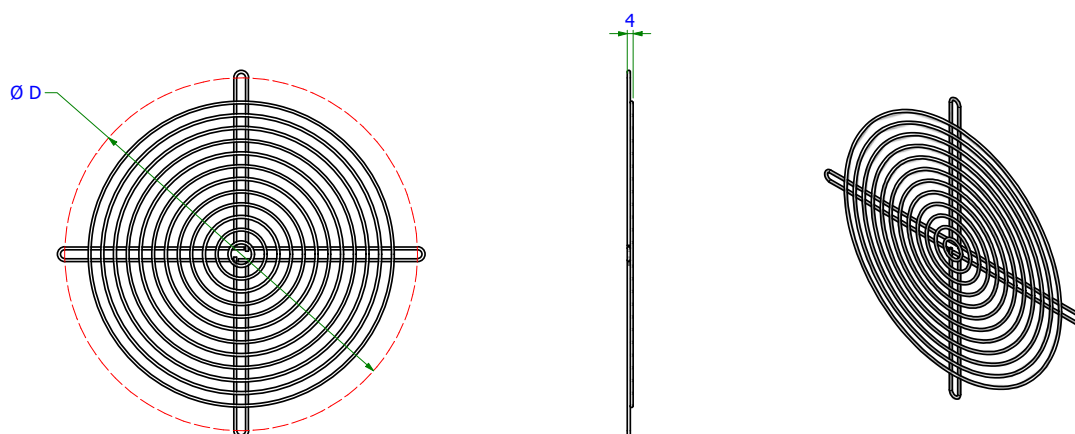

MODEL	RELATED PRODUCT	ØD
AE PM315	DF315, M315	355
AE PM355	DF355, M355	395
AE PM400	DF400, M400	450
AE PM450	DF450, M450	500
AE PM500	DF500, M500	560
AE PM560	DF560, M560	620
AE PM630	DF630, M630	690
AE PM710	DF710, M710	770
AE PM800	DF800, M800	860
AE PM900	DF900, M900	970
AE PM1000	DF1000, M1000	1070
AE PM1120	DF1120, M1120	1190
AE PM1250	DF1250, M1250	1320
AE PM1400	DF1400, M1400	1470

AUXILIARY EQUIPMENT - INLET CONE



- Inlet cone for better airflow. Made of steel.

PRODUCT DIMENSIONS

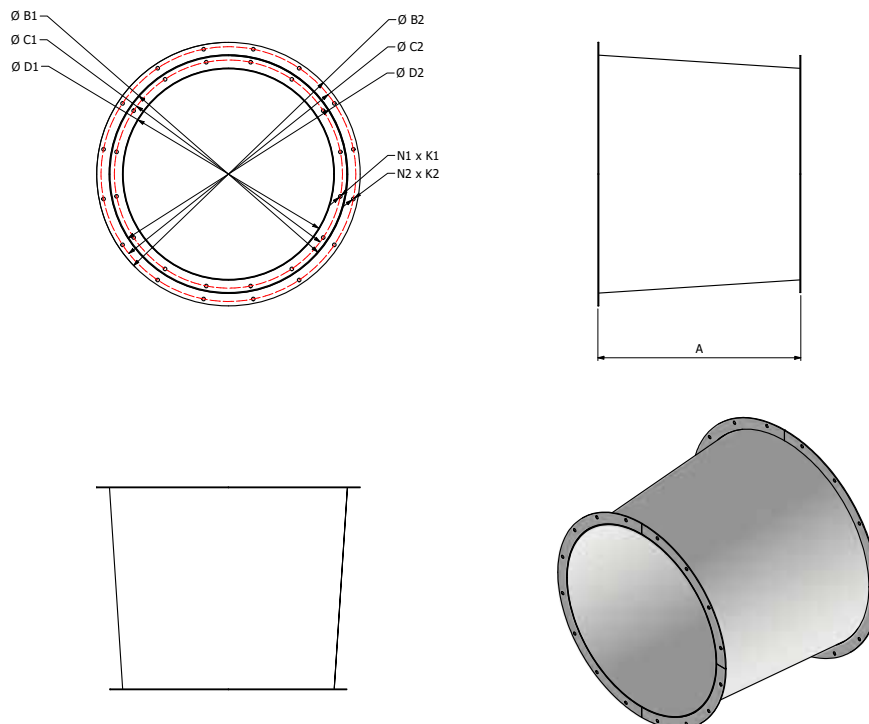

MODEL	RELATED PRODUCT	A	B1	B2	C1	C2	D1	D2	N1 x K1	N2 x K2
AE IC400	DF400, M400	300	480	530	450	500	400	450	8 x 10	8 x 12
AE IC450	DF450, M450	300	530	590	500	560	450	500	8 x 12	12 x 12
AE IC500	DF500, M500	350	590	650	560	620	500	560	12 x 12	12 x 12
AE IC560	DF560, M560	350	650	720	620	690	560	630	12 x 12	12 x 12
AE IC630	DF630, M630	400	720	800	690	770	630	710	12 x 12	16 x 12
AE IC710	DF710, M710	400	800	890	770	860	710	800	16 x 12	16 x 12
AE IC800	DF800, M800	450	890	1005	860	970	800	900	16 x 12	16 x 15
AE IC900	DF900, M900	450	1005	1105	970	1070	900	1000	16 x 15	16 x 15
AE IC1000	DF1000, M1000	500	1105	1260	1070	1190	1000	1120	16 x 15	20 x 15
AE IC1120	DF1120, M1120	500	1260	1390	1190	1320	1120	1250	20 x 15	20 x 15
AE IC1250	DF1250, M1250	700	1390	1540	1320	1470	1250	1400	20 x 15	20 x 15

AUXILIARY EQUIPMENT - COUNTER FLANGE



- Flange made of electrostatic powder coated steel. It manufactured to withstand 300°C and 400°C for 2 hours and uninterrupted.

PRODUCT DIMENSIONS

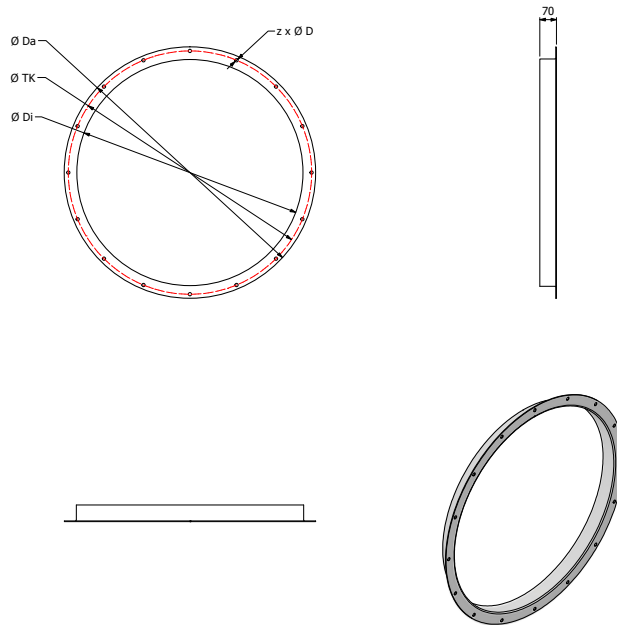

MODEL	RELATED PRODUCT	ØDi	ØTK	ØDa	z x ØD
AE CF315	DF315, M315	315	355	395	8 x 10
AE CF355	DF355, M355	355	395	435	8 x 10
AE CF400	DF400, M400	400	450	480	8 x 12
AE CF450	DF450, M450	450	500	530	8 x 12
AE CF500	DF500, M500	500	560	590	12 x 12
AE CF560	DF560, M560	560	620	650	12 x 12
AE CF630	DF630, M630	630	690	720	12 x 12
AE CF710	DF710, M710	710	770	800	16 x 12
AE CF800	DF800, M800	800	860	890	16 x 12
AE CF900	DF900, M900	900	970	1005	16 x 15
AE CF1000	DF1000, M1000	1000	1070	1105	16 x 15
AE CF1120	DF1120, M1120	1120	1190	1260	20 x 15
AE CF1250	DF1250, M1250	1250	1320	1390	20 x 15
AE CF1400	DF1400, M1400	1400	1470	1540	20 x 15

AUXILIARY EQUIPMENT - COUNTER FLANGE WITH FLEXIBLE CONNECTOR



- Flexible connection with frame made of galvanized sheet steel is assembled to Counter flange. Flexible middle section made of PVC woven cloth with a temperature range up to +70°C.

PRODUCT DIMENSIONS

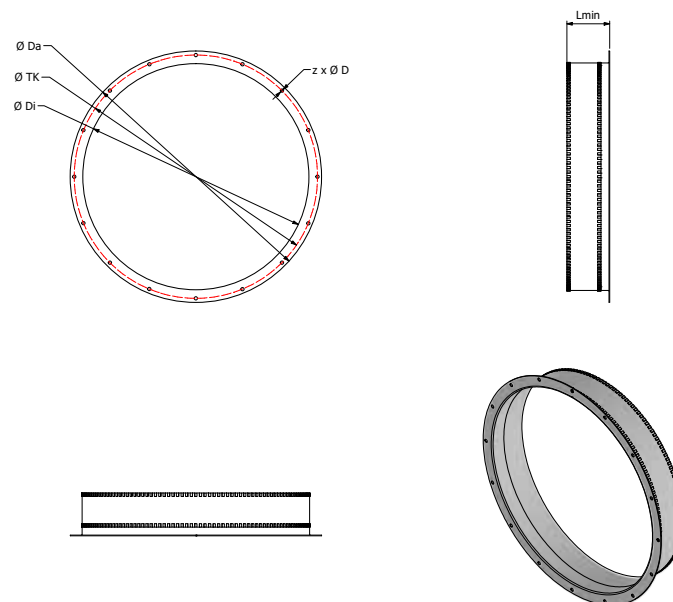

MODEL	RELATED PRODUCT	ØDi	ØTK	ØDa	z x ØD	Lmin
AE FJF315	DF315, M315	315	355	395	8 x 10	100
AE FJF355	DF355, M355	355	395	435	8 x 10	100
AE FJF400	DF400, M400	400	450	480	8 x 12	100
AE FJF450	DF450, M450	450	500	530	8 x 12	100
AE FJF500	DF500, M500	500	560	590	12 x 12	100
AE FJF560	DF560, M560	560	620	650	12 x 12	100
AE FJF630	DF630, M630	630	690	720	12 x 12	100
AE FJF710	DF710, M710	710	770	800	16 x 12	100
AE FJF800	DF800, M800	800	860	890	16 x 12	100
AE FJF900	DF900, M900	900	970	1005	16 x 15	100
AE FJF1000	DF1000, M1000	1000	1070	1105	16 x 15	100
AE FJF1120	DF1120, M1120	1120	1190	1260	20 x 15	100
AE FJF1250	DF1250, M1250	1250	1320	1390	20 x 15	100
AE FJF1400	DF1400, M1400	1400	1470	1540	20 x 15	100

AUXILIARY EQUIPMENT - COUNTER FLANGE WITH F400 FLEXIBLE CONNECTOR



- Flexible connection with frame made of galvanized sheet steel is assembled to Counter flange. Flexible middle section made of silicone withstand 300°C and 400°C for 2 hours and uninterrupted.

PRODUCT DIMENSIONS

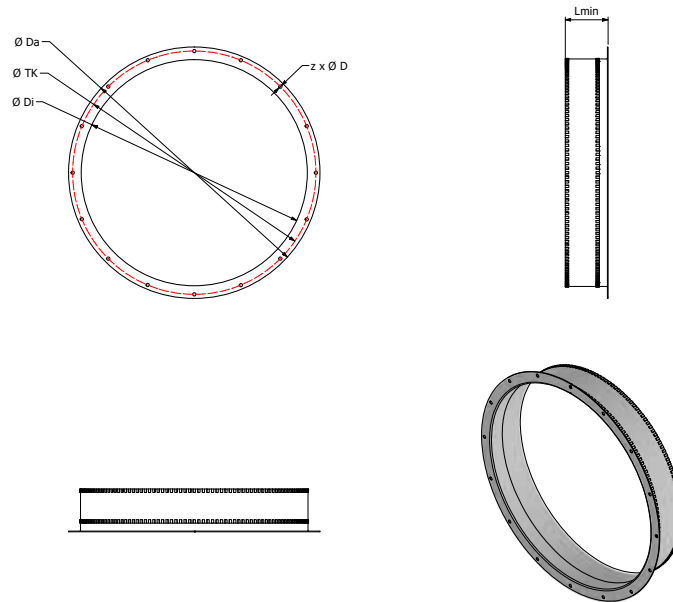

MODEL	RELATED PRODUCT	ØDi	ØTK	ØDa	z x ØD	Lmin
AE FJF315	DF315, M315	315	355	395	8 x 10	100
AE FJF355	DF355, M355	355	395	435	8 x 10	100
AE FJF400	DF400, M400	400	450	480	8 x 12	100
AE FJF450	DF450, M450	450	500	530	8 x 12	100
AE FJF500	DF500, M500	500	560	590	12 x 12	100
AE FJF560	DF560, M560	560	620	650	12 x 12	100
AE FJF630	DF630, M630	630	690	720	12 x 12	100
AE FJF710	DF710, M710	710	770	800	16 x 12	100
AE FJF800	DF800, M800	800	860	890	16 x 12	100
AE FJF900	DF900, M900	900	970	1005	16 x 15	100
AE FJF1000	DF1000, M1000	1000	1070	1105	16 x 15	100
AE FJF1120	DF1120, M1120	1120	1190	1260	20 x 15	100
AE FJF1250	DF1250, M1250	1250	1320	1390	20 x 15	100
AE FJF1400	DF1400, M1400	1400	1470	1540	20 x 15	100

AUXILIARY EQUIPMENT - DOUBLE COUNTER FLANGE WITH FLEXIBLE CONNECTOR

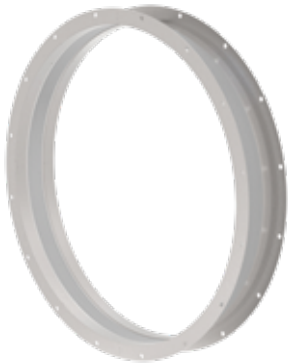

- Flexible connection with frame made of galvanized sheet steel is assembled to Counter flange. Flexible middle section made of PVC woven cloth with a temperature range up to +70°C.

PRODUCT DIMENSIONS

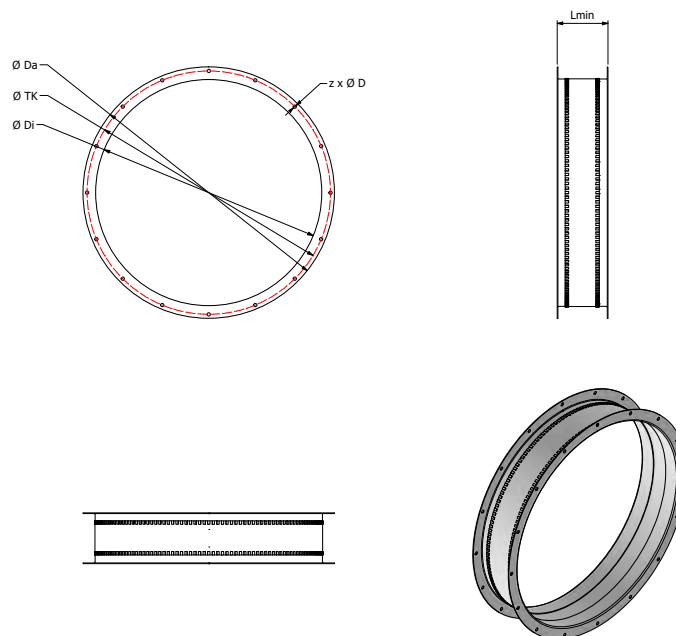

MODEL	RELATED PRODUCT	ØDi	ØTK	ØDa	z x ØD	Lmin
AE FJ2F315	DF315, M315	315	355	395	8 x 10	170
AE FJ2F355	DF355, M355	355	395	435	8 x 10	170
AE FJ2F400	DF400, M400	400	450	480	8 x 12	170
AE FJ2F450	DF450, M450	450	500	530	8 x 12	170
AE FJ2F500	DF500, M500	500	560	590	12 x 12	170
AE FJ2F560	DF560, M560	560	620	650	12 x 12	170
AE FJ2F630	DF630, M630	630	690	720	12 x 12	170
AE FJ2F710	DF710, M710	710	770	800	16 x 12	170
AE FJ2F800	DF800, M800	800	860	890	16 x 12	170
AE FJ2F900	DF900, M900	900	970	1005	16 x 15	170
AE FJ2F1000	DF1000, M1000	1000	1070	1105	16 x 15	170
AE FJ2F1120	DF1120, M1120	1120	1190	1260	20 x 15	170
AE FJ2F1250	DF1250, M1250	1250	1320	1390	20 x 15	170
AE FJ2F1400	DF1400, M1400	1400	1470	1540	20 x 15	170

AUXILIARY EQUIPMENT - DOUBLE COUNTER FLANGE WITH F400 FLEXIBLE CONNECTOR

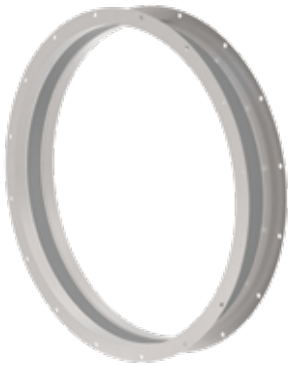

- Flexible connection with frame made of galvanized sheet steel is assembled to double Counter flange. Flexible middle section made of silicone withstand 300 °C and 400 °C for 2 hours and uninterrupted.

PRODUCT DIMENSIONS

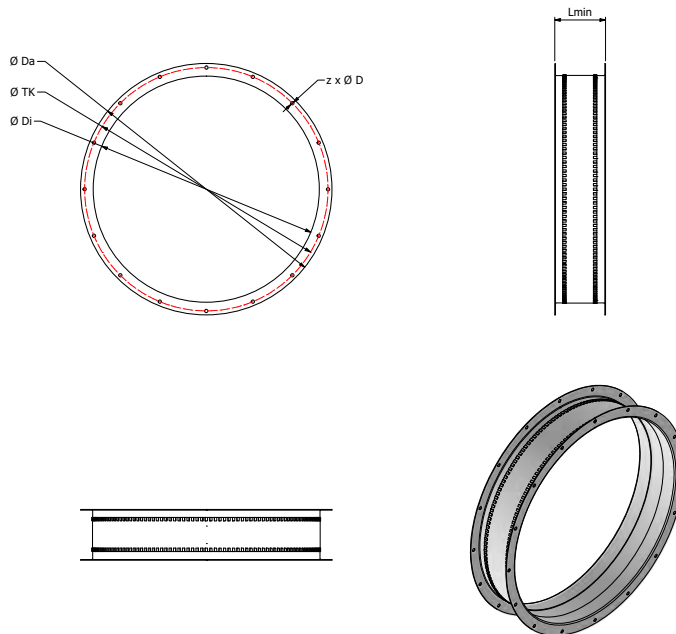

MODEL	RELATED PRODUCT	ØDi	ØTK	ØDa	z x ØD	Lmin
AE FJ2F315HR	DF315, M315	315	355	395	8 x 10	170
AE FJ2F355HR	DF355, M355	355	395	435	8 x 10	170
AE FJ2F400HR	DF400, M400	400	450	480	8 x 12	170
AE FJ2F450HR	DF450, M450	450	500	530	8 x 12	170
AE FJ2F500HR	DF500, M500	500	560	590	12 x 12	170
AE FJ2F560HR	DF560, M560	560	620	650	12 x 12	170
AE FJ2F630HR	DF630, M630	630	690	720	12 x 12	170
AE FJ2F710HR	DF710, M710	710	770	800	16 x 12	170
AE FJ2F800HR	DF800, M800	800	860	890	16 x 12	170
AE FJ2F900HR	DF900, M900	900	970	1005	16 x 15	170
AE FJ2F1000HR	DF1000, M1000	1000	1070	1105	16 x 15	170
AE FJ2F1120HR	DF1120, M1120	1120	1190	1260	20 x 15	170
AE FJ2F1250HR	DF1250, M1250	1250	1320	1390	20 x 15	170
AE FJ2F1400HR	DF1400, M1400	1400	1470	1540	20 x 15	170

AUXILIARY EQUIPMENT - CIRCULAR SILENCER



- Nominal insulation thickness is 50-100 mm. Pod can be used when the acoustic requirements exceed the performance capabilities of the silencer and fan. Especially suitable for the big dimensions. ($\lt; \text{Ø}630$) Silencer should be mounted directly before or after the fan. The silencers are supplied with a flange.

PRODUCT DIMENSIONS

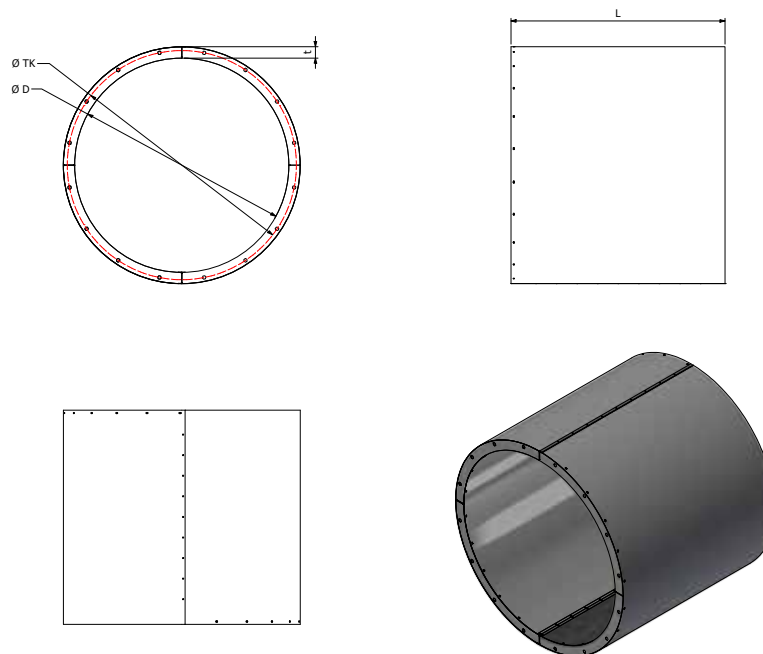

MODEL	RELATED PRODUCT	ØDi	ØTK	ØDa	L	t
AE S315D100	DF315, M315	315	355	395	1 x D	100
AE S355D100	DF355, M355	355	395	435	1 x D	100
AE S400D100	DF400, M400	400	450	480	1 x D	100
AE S450D100	DF450, M450	450	500	530	1 x D	100
AE S500D100	DF500, M500	500	560	590	1 x D	100
AE S560D100	DF560, M560	560	620	650	1 x D	100
AE S630D100	DF630, M630	630	690	720	1 x D	100
AE S710D100	DF710, M710	710	770	800	1 x D	100
AE S800D100	DF800, M800	800	860	890	1 x D	100
AE S900D100	DF900, M900	900	970	1005	1 x D	100
AE S1000D100	DF1000, M1000	1000	1070	1105	1 x D	100
AE S1120D100	DF1120, M1120	1120	1190	1260	1000	100
AE S1250D100	DF1250, M1250	1250	1320	1390	1000	100
AE S1250D100	DF1400, M1400	1400	1470	1540	1000	100

OUTLET COWL



- Outlet cowl made from galvanized steel or painted black steel, with flange holes. To be used for protection of products inlet mouth from wheather conditions.

PRODUCT DIMENSIONS

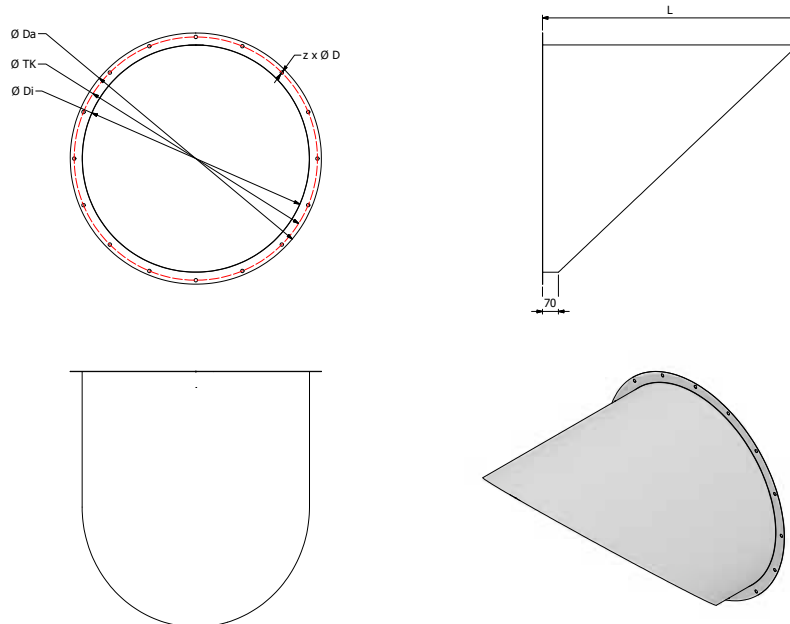

MODEL	RELATED PRODUCT	$\varnothing Di$	$\varnothing Da$	$\varnothing TK$	$z \times \varnothing D$	L	I
AE OC315	DF315, M315	317,5	395	355	8 x 10	340	25
AE OC355	DF355, M355	357,5	435	395	8 x 10	380	25
AE OC400	DF400, M400	402,5	480	450	8 x 10	450	50
AE OC450	DF450, M450	452,5	530	500	8 x 12	500	50
AE OC500	DF500, M500	502,5	590	560	12 x 12	550	50
AE OC560	DF560, M560	562,5	650	620	12 x 12	610	50
AE OC630	DF630, M630	632,5	720	690	12 x 12	680	50
AE OC710	DF710, M710	712,5	800	770	16 x 12	760	50
AE OC800	DF800, M800	802,5	890	860	16 x 12	850	50
AE OC900	DF900, M900	902,5	1005	970	16 x 15	950	50
AE OC1000	DF1000, M1000	1003,5	1105	1070	16 x 15	1100	100
AE OC1120	DF1120, M1120	1123,5	1260	1190	20 x 15	1220	100
AE OC1250	DF1250, M1250	1253,5	1390	1320	20 x 15	1350	100
AE OC1400	DF1400, M1400	1403,5	1540	1470	20 x 15	1500	100

VANE



- To use provides streamlined flow.

PRODUCT DIMENSIONS

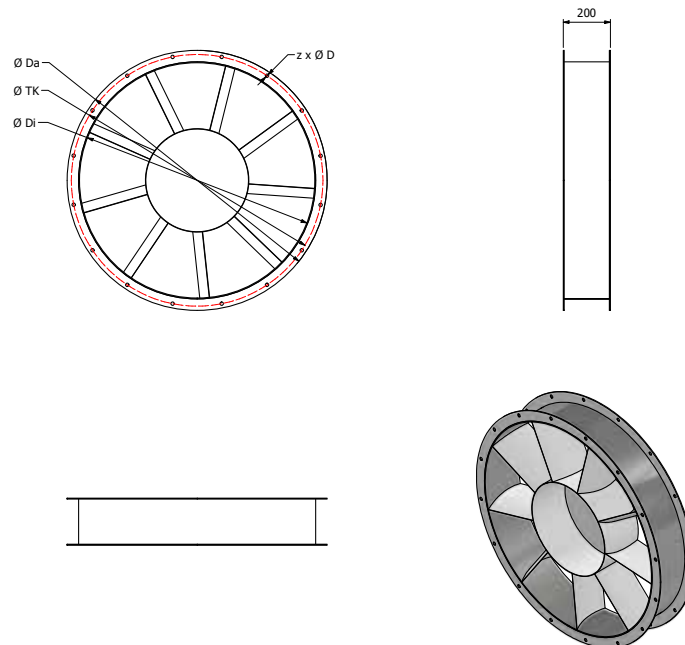

MODEL	RELATED PRODUCT	$\varnothing Di$	$\varnothing TK$	$\varnothing Da$
AE V315	DF315, M315	315	355	395
AE V355	DF355, M355	355	395	435
AE V400	DF400, M400	400	450	480
AE V450	DF450, M450	450	500	530
AE V500	DF500, M500	500	560	590
AE V560	DF560, M560	560	620	650
AE V630	DF630, M630	630	690	720
AE V710	DF710, M710	710	770	800
AE V800	DF800, M800	800	860	890
AE V900	DF900, M900	900	970	1005
AE V1000	DF1000, M1000	1000	1070	1105
AE V1120	DF1120, M1120	1120	1190	1260
AE V1250	DF1250, M1250	1250	1320	1390
AE V1400	DF1400, M1400	1400	1470	1540

AUXILIARY EQUIPMENT - DUCT TYPES RECTUNGULAR SILENCER



- Duct type sound attenuator, frame made of galvanised steel sheet. This guarantees a high acoustic insulation and low pressure loss by aerodynamically optimized guide plates. Maximum air velocity 10 m/s, maximum temperature 100°C.

PRODUCT DIMENSIONS

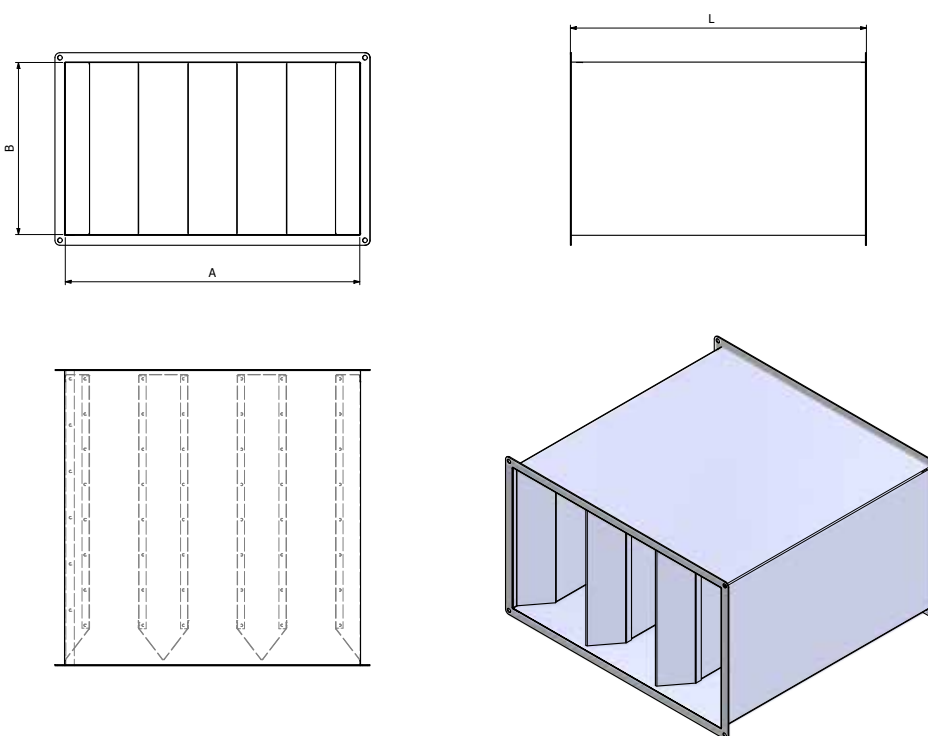

MODEL	RELATED PRODUCT	A	B	L
AE RS 30-15	KOI-RB 30-15M	300	150	600
AE RS 40-20	KOI-RB 40-20MV1-MV2	400	200	600
AE RS 50-25	KOI-RB 50-25M	500	250	600
AE RS 50-30	KOI-RB 50-30M	500	300	600
AE RS 60-30	KOI-RB 60-30M	600	300	600
AE RS 60-35	KOI-RB 60-35MV1-MV2, KOI-REB 50-35TV1-TV2	600	350	600
AE RS 70-40	KOI-RB 70-40MV1, KOI-REB 70-40TV1-TV2	700	400	600
AE RS 80-50	KOI-RB 80-50M-T	800	500	600
AE RS 100-50	KOI-RB 100-50T KOI-REB 100-50T	1000	500	600

DUCT TYPES ELECTRICAL HEATER



- Duct types heaters are designed for use in comfort heating applications such as makeup air heating.



PRODUCT DIMENSIONS

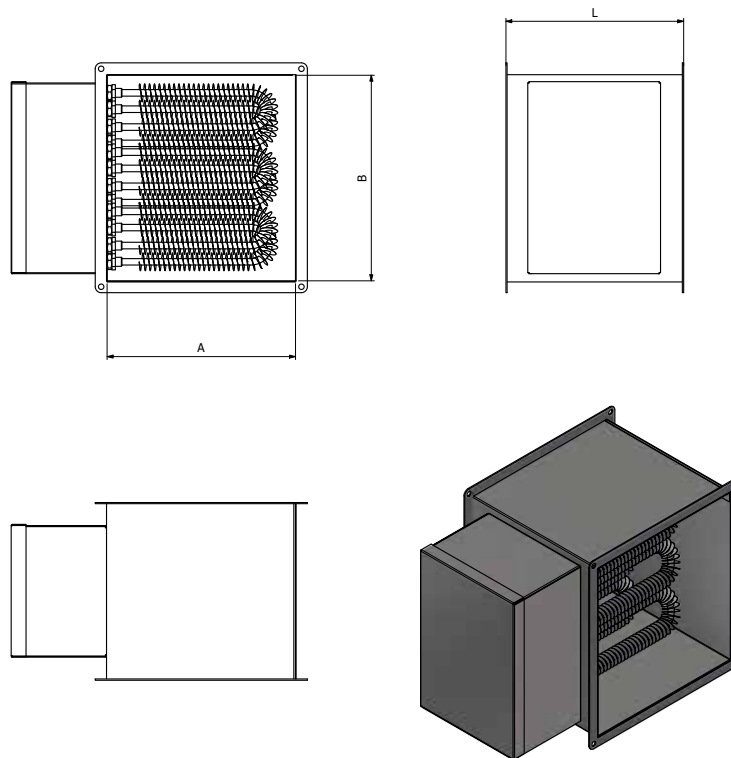

MODEL	RELATED PRODUCT	A	B	L	CAPACITY KW	STAGE
AE EH 30-15	KOI-RB 30-15M	300	150	150	2	1
AE EH 40-20	KOI-RB 40-20MV1-MV2	400	200	150	2	1
AE EH 50-25	KOI-RB 50-25M	500	250	250	4	2
AE EH 50-30	KOI-RB 50-30M	500	300	250	4	2
AE EH 60-30	KOI-RB 60-30M	600	300	350	6	3
AE EH 60-35	KOI-RB 60-35MV1-MV2, KOI-REB 50-35TV1-TV2	600	350	350	6	3
AE EH 70-40	KOI-RB 70-40MV1, KOI-REB 70-40TV1-TV2	700	400	350	8	3
AE EH 80-50	KOI-RB 80-50M-T	800	500	350	12	3
AE EH 100-50	KOI-RB 100-50T KOI-REB 100-50T	1000	500	350	16	3

RECTANGULAR FLEXIBLE CONNECTOR



- Duct type sound attenuator, frame made of galvanised steel sheet. This guarantees a high acoustic insulation and low pressure loss by aerodynamically optimized guide plates. Maximum air velocity 10 m/s, maximum temperature 100°C.

PRODUCT DIMENSIONS

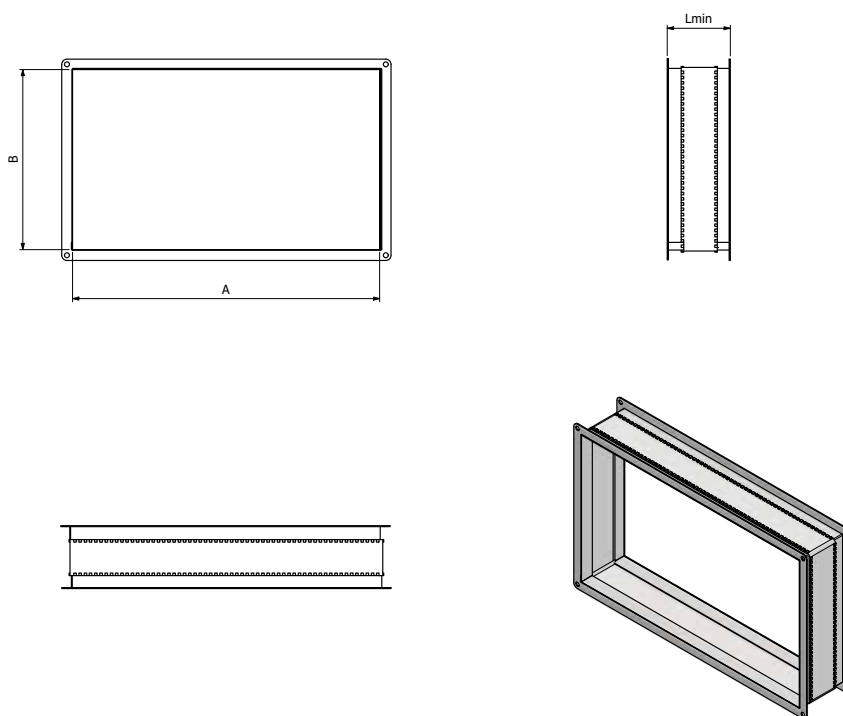

MODEL	RELATED PRODUCT	A	B	Lmin
AE DFC 30-15	KOI-RB 30-15M	300	150	100
AE DFC 40-20	KOI-RB 40-20MV1-MV2	400	200	100
AE DFC 50-25	KOI-RB 50-25M	500	250	100
AE DFC 50-30	KOI-RB 50-30M	500	300	100
AE DFC 60-30	KOI-RB 60-30M	600	300	100
AE DFC 60-35	KOI-RB 60-35MV1-MV2, KOI-REB 50-35TV1-TV2	600	350	100
AE DFC 70-40	KOI-RB 70-40MV1, KOI-REB 70-40TV1-TV2	700	400	100
AE DFC 80-50	KOI-RB 80-50M-T	800	500	100
AE DFC 100-50	KOI-RB 100-50T KOI-REB 100-50T	1000	500	100

ROOF ADAPTER FRAME



- Duct types heaters are designed for use in comfort heating applications such as makeup air heating.

PRODUCT DIMENSIONS

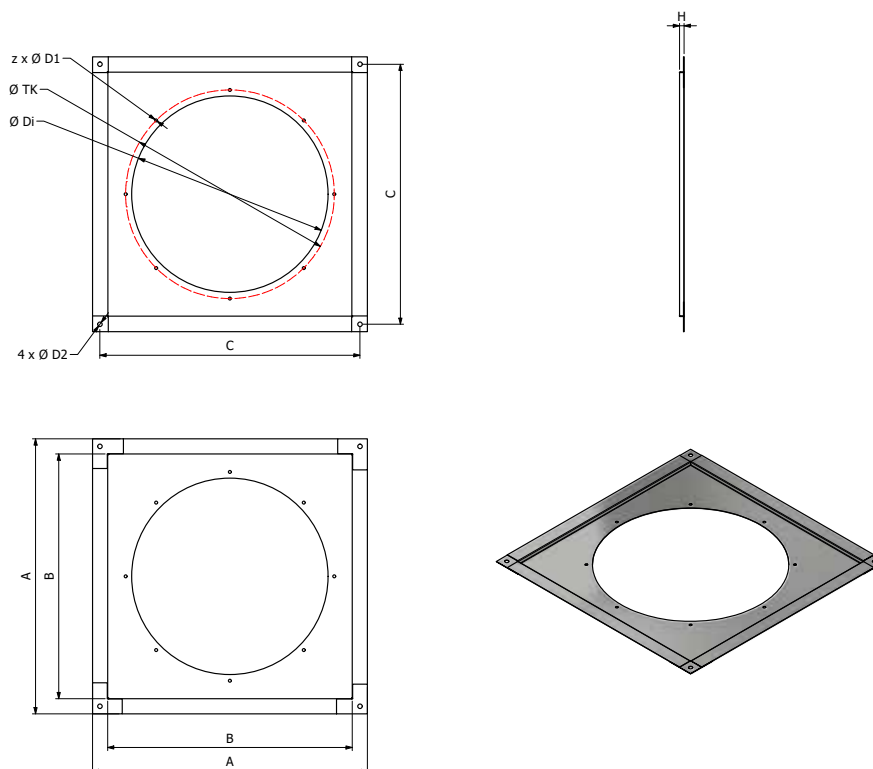

MODEL	RELATED PRODUCT	A	B	C	ØDi	ØTK	z x ØD1	ØD2	H
AE AF190	H190	330	260	275	200	240	6xØ8	Ø10	20
AE AF225	H225	400	330	365	200	240	6xØ8	Ø10	20
AE AF250	H250	400	330	365	230	270	6xØ8	Ø10	25
AE AF280	H280	460	390	425	230	270	6xØ8	Ø10	25
AE AF355	H355	520	420	470	260	300	6xØ10	Ø12	30
AE AF400	H400	560	460	510	260	300	6xØ10	Ø12	30
AE AF450	H450	670	540	605	260	300	6xØ10	Ø12	40
AE AF500	H500	750	610	680	260	300	6xØ10	Ø12	40

Over size which is not listed above, please check your representative to get technical information.

FLAT ROOF SOCKET



- Flat roof socket is made of steel sheet supplied with 25-50 mm insulation on demand. To be used for additional protection for sound and outdoor weather conditions. (Roof Curb)

PRODUCT DIMENSIONS

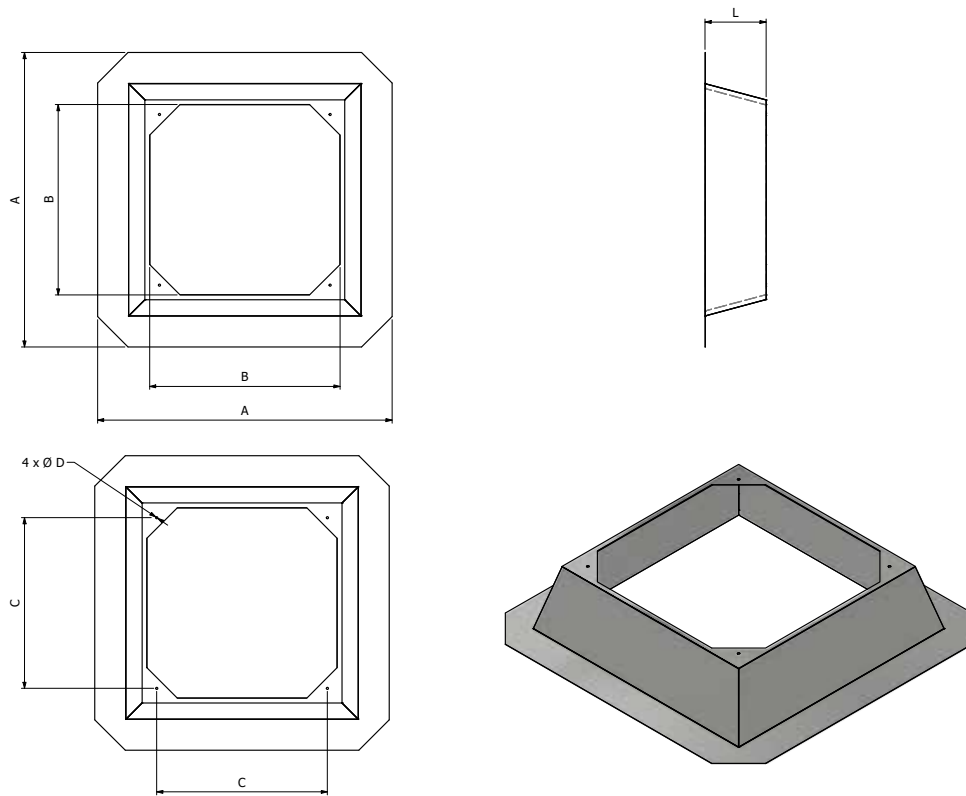

MODEL	RELATED PRODUCT	A	B	C	ØD	L
AE FRS190	H190	880	610	590	ø10	300
AE FRS225	H225	960	670	650	ø10	300
AE FRS250	H250	960	670	650	ø10	300
AE FRS280	H280	1020	730	710	ø10	300
AE FRS355	H355	1060	770	750	ø12	300
AE FRS400	H400	1100	810	790	ø12	300
AE FRS450	H450	1215	925	905	ø12	300
AE FRS500	H500	1290	1000	980	ø12	300

Over size which is not listed above, please check your representative to get technical information.

SOCKET SILENCER



- Socket silencer on demand accessories for special requirements at the inlet side. The sound absorption at 250 Hz is on average 6-8 dB. The units are abrasion resistant up to a velocity of 20 m/s.

PRODUCT DIMENSIONS

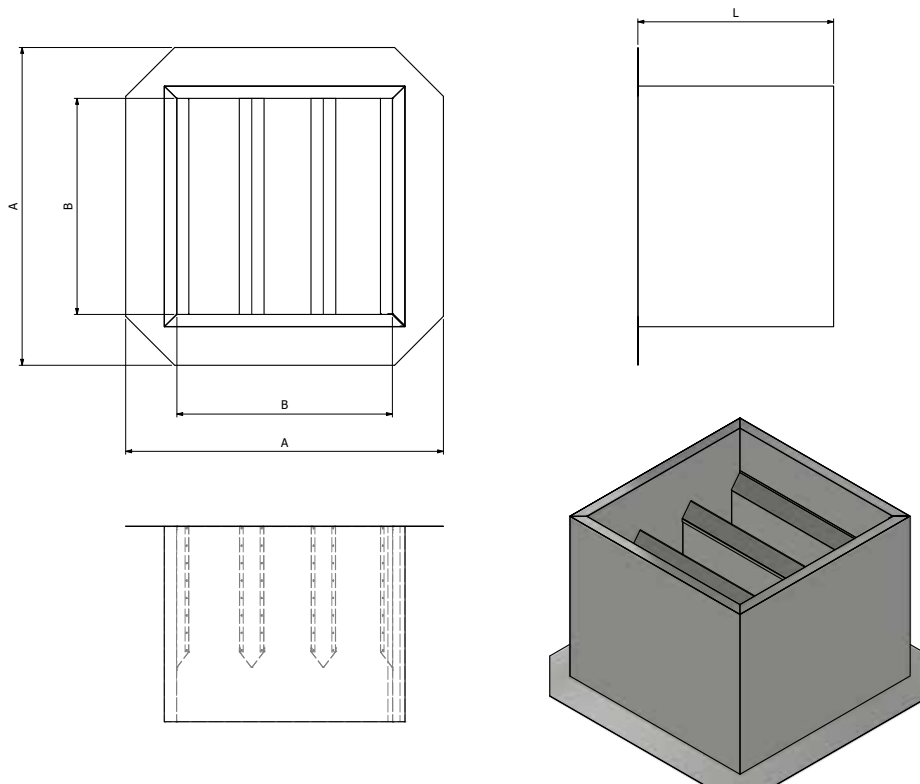

MODEL	RELATED PRODUCT	A	B	L
AE SS190	H190	620	295	400
AE SS225	H225	680	355	400
AE SS250	H250	680	355	400
AE SS280	H280	740	415	400
AE SS355	H355	780	455	650
AE SS400	H400	820	495	650
AE SS450	H450	935	570	650
AE SS500	H500	1015	650	650

Over size which is not listed above, please check your representative to get technical information.

ROOF CONNECTION BOX

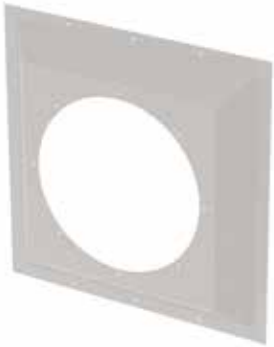

- For mounting on socket silencers to fix inlet accessories and duct system. The framework consist of galvanized steel.

PRODUCT DIMENSIONS

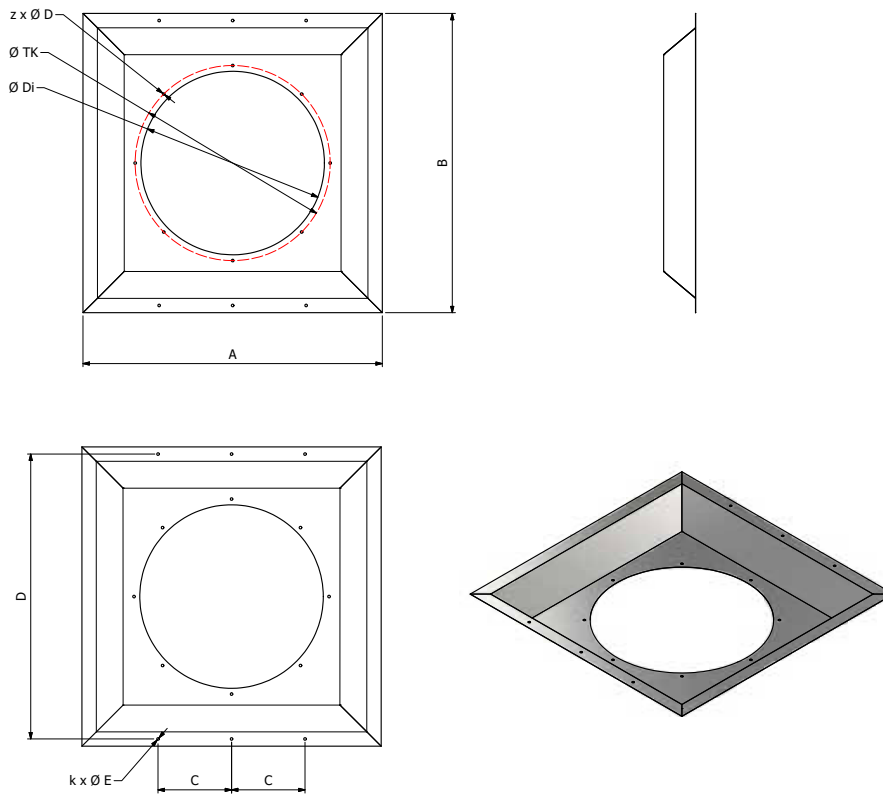

MODEL	RELATED PRODUCT	A	H	I	L
AE CB190	H190	330	312	95	110
AE CB225	H225	400	382	114	110
AE CB250	H250	400	381	135	110
AE CB280	H280	460	438	150	110
AE CB355	H355	520	495	214	110
AE CB400	H400	560	530	229	110
AE CB450	H450	670	635	241	110
AE CB500	H500	750	710	269	110

Over size which is not listed above, please check your representative to get technical information.

ROOF FANS INLET FLANGE



- Use for matching application area and accessories or products as a connection part.

PRODUCT DIMENSIONS

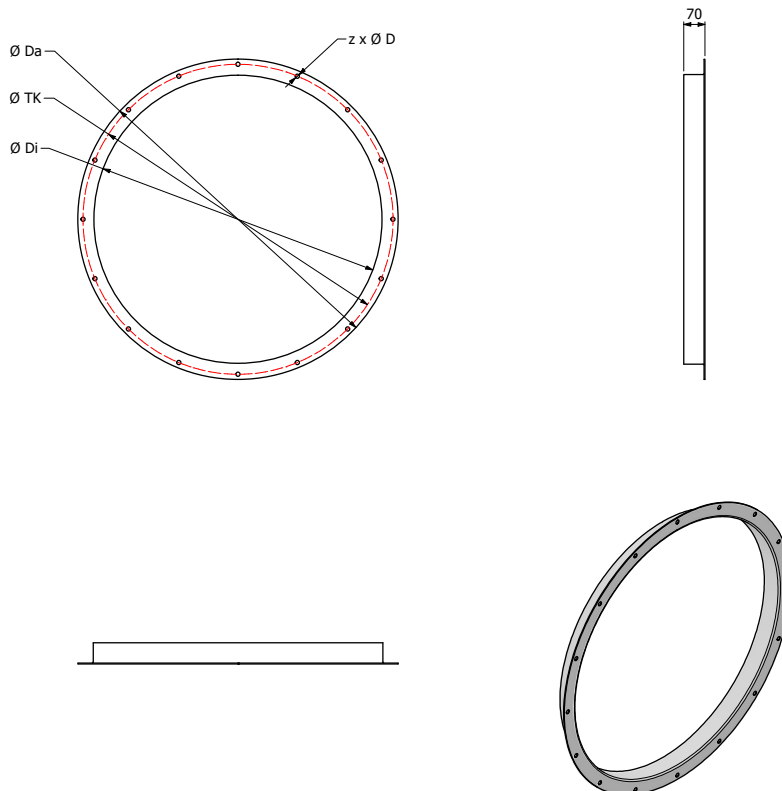

MODEL	RELATED PRODUCT	A	H	I	L
AE CB190	H190	330	312	95	110
AE CB225	H225	400	382	114	110
AE CB250	H250	400	381	135	110
AE CB280	H280	460	438	150	110
AE CB355	H355	520	495	214	110
AE CB400	H400	560	530	229	110
AE CB450	H450	670	635	241	110
AE CB500	H500	750	710	269	110

Over size which is not listed above, please check your representative to get technical information.

ROOF FANS FLEXIBLE CONNECTION

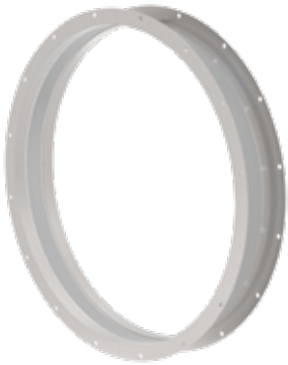

- To observe the minimum vibrations and complete smooth connection. Manufactured from galvanized steel. The flexible part made from neoprene coated fabric and flanges made from galvanized steel.

PRODUCT DIMENSIONS

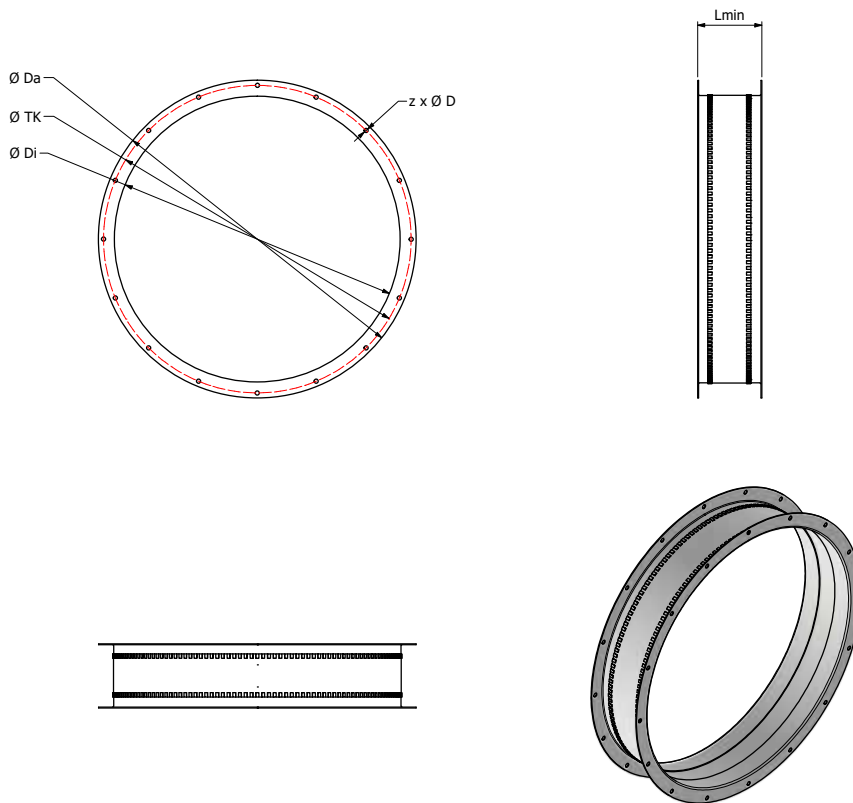

MODEL	RELATED PRODUCT	ØDi	ØTK	ØDa	Lmin	z x ØD
AE RFC190	H190	200	240	280	170	6xØ8
AE RFC225	H225	200	240	280	170	6xØ8
AE RFC250	H250	230	270	310	170	6xØ8
AE RFC280	H280	230	270	310	170	6xØ8
AE RFC355	H355	260	300	340	170	6xØ10
AE RFC400	H400	260	300	340	170	6xØ10
AE RFC450	H450	260	300	340	170	6xØ10
AE RFC500	H500	260	300	340	170	6xØ10

Over size which is not listed above, please check your representative to get technical information.

SAFETY SWITCH



- ON / OFF-switch For the security and the electrical equipment. Protection class IP55. Suitable for temperatures up to +120°C.

Safety Switch		CAPACITY
MODEL	INFORMATION	kW
AE-MSS-5,5-eco	3*20 A BOXED ECO	5,5
AE-MSS-5,5	3*20 A BOXED	5,5
AE-MSS-7,5	3*25 A BOXED	7,5
AE-MSS-11	3*32 A BOXED	11
AE-MSS-15	3*40 A BOXED	15
AE-MSS-22	3*64 A BOXED	22
AE-MSS-30	3*80 A BOXED	30
AE-MSS-37	3*100 A BOXED	37
AE-MSS-45	3*125 A BOXED 64*64	45

SAFETY SWITCH TRACKABLE



- ON / OFF-switch For the security and the electrical equipment. Protection class IP55. Suitable for temperatures up to +120°C.

Safety Switch Trackable		CAPACITY
MODEL	INFORMATION	kW
AE-ACMSS-5,5-eco	3*20 A BOXED ECO	5,5
AE-ACMSS-5,5	3*20 A BOXED	5,5
AE-ACMSS-7,5	3*25 A BOXED	7,5
AE-ACMSS-11	3*32 A BOXED	11
AE-ACMSS-15	3*40 A BOXED	15
AE-ACMSS-22	3*64 A BOXED	22
AE-ACMSS-30	3*80 A BOXED	30
AE-ACMSS-37	3*100 A BOXED	37
AE-ACMSS-45	3*125 A BOXED 64*64	45
AE-ACMSS-45	3*125 A BOXED 88*88	45

MONOPHASE SPEED CONTROLLER



- This controller is used for the continuous speed adjustment of fans with voltage controlled single phase asynchronous motors. The rotation is being controlled through voltage reduction by means of a power thyristor (phase angle control) across the complete range from 0 - 230V. Several fans can be connected to one controller, if the total of the supplies does not exceed the rated current of the controller. The operation is carried out by the rotary switch of the controllers. There is an adjusting screw on the inside of the controllers, which can be set up to limit the minimum fan speed.

Monophase Speed Controller	CAPACITY	VOLTAGE
MODEL	W	V
AESCU2,5A	0-160	230
AESCU5A	160-500	230
AESCU8A	500-1000	230

FREQUENCY INVERTER



- Optimized frequency inverter for energetically optimal operation. Graphical control unit features intuitive operation and allows a quick setup. Permanent operation at maximum output power and ambient temperature up to 50°C possible. By default coated electronics. New generation and BMS controlled system construction technology ensures low power dissipation and also saves energy. Delivery with pre-configured parameter setting by the manufacturer.

Frequency Inverter	CAPACITY	VOLTAGE
MODEL	KW	V
AESCU0,75	0,75	400
AESCU1,5	1,5	400
AESCU2,2	2,2	400
AESCU3	3	400
AESCU4	4	400
AESCU5,5	5,5	400
AESCU7,5	7,5	400
AESCU11	11	400
AESCU15	15	400
AESCU18,5	18,5	400
AESCU22	22	400
AESCU30	30	400
AESCU37	37	400
AESCU45	45	400
AESCU55	55	400

AUXILIARY EQUIPMENT - PRESSURIZATION CONTROL PANEL



Pressurization Control Panel	Frequency Inverter FC102
Model	kW
PAP4	4
PAP5,5	5,5
PAP7,5	7,5
PAP11	11
PAP15	15
PAP18,5	18,5
PAP22	22
PAP30	30

AUXILIARY EQUIPMENT - DIFFERENTIAL PRESSURE SENSOR



- The Differential Pressure Switch is ideal for air filtration system monitoring, static pressure proving, airflow proving, or auxiliary fan actuation

Differential Pressure Sensor	VOLTAGE
Model	V
PDS50	24

AUXILIARY EQUIPMENT - DIFFERENTIAL PRESSURE SENSOR + PI (0-10 V output)



- The differential pressure sensor is connected to the ventilation system by two pressure connections and can regulate the air pressure or air volume flow via the control unit.

Differential Pressure Sensor + PI	VOLTAGE
Model	V
PIPDS50	24

AUXILIARY EQUIPMENT - DUCT TYPE SMOKE SENSOR



- Duct type smoke detectors are used for detecting smoke and products of combustion present.

Duct Type Smoke Sensor	VOLTAGE
Model	V
SD50	24

AUXILIARY EQUIPMENT - G4 PANEL FILTER



G4 Panel Filter	WIDTH	HIEGHT	DEPTH
MODEL	mm	mm	mm
AEPF-G4-287X287X48	278	278	48
AEPF-G4-400X500X48	400	500	48
AEPF-G4-500X500X48	500	500	48
AEPF-G4-500X625X48	500	625	48
AEPF-G4-287X592X48	287	592	48
AEPF-G4-490X592X48	490	592	48
AEPF-G4-592X592X48	592	592	48
AEPF-G4-287X287X98	287	287	98
AEPF-G4-400X500X98	400	500	98
AEPF-G4-500X500X98	500	500	98
AEPF-G4-500X625X98	500	625	98
AEPF-G4-287X592X98	287	592	98
AEPF-G4-490X592X98	490	592	98
AEPF-G4-592X592X98	592	592	98

AUXILIARY EQUIPMENT - G2-G3 PANEL FILTER



G2-G3 Panel Filter	WIDTH	HIEGHT	DEPTH
MODEL	mm	mm	mm
AEPF-G2-G3-287X287X48	287	278	48
AEPF-G2-G3-400X500X48	400	500	48
AEPF-G2-G3-500X500X48	500	500	48
AEPF-G2-G3-500X625X48	500	625	48
AEPF-G2-G3-287X592X48	287	592	48
AEPF-G2-G3-490X592X48	490	592	48
AEPF-G2-G3-592x592x48	592	592	48

AUXILIARY EQUIPMENT - G2 METAL GRASE HOLDER FILTER



G2 Metal Grease Holder Filter	WIDTH	HIEGHT	DEPTH
MODEL	mm	mm	mm
AEMF-G2-287X287X24	287	278	24
AEMF-G2-400X500X24	400	500	24
AEMF-G2-500X500X24	500	500	24
AEMF-G2-500X625X24	500	625	24
AEMF-G2-287X592X24	287	592	24
AEMF-G2-490X592X24	490	592	24
AEMF-G2-592X592X24	592	592	24

AUXILIARY EQUIPMENT - G2-G3 METAL GRASE HOLDER FILTER



G2-G3 Metal Grease Holder Filter	WIDTH	HIEGHT	DEPTH
MODEL	mm	mm	mm
AEMF-G2-G3-287X287X48	287	278	48
AEMF-G2-G3-400X500X48	400	500	48
AEMF-G2-G3-500X500X48	500	500	48
AEMF-G2-G3-500X625X48	500	625	48
AEMF-G2-G3-287X592X48	287	592	48
AEMF-G2-G3-490X592X48	490	592	48
AEMF-G2-G3-592X592X48	592	592	48

AUXILIARY EQUIPMENT - FILTER FRAME



Filter Frame	WIDTH	HIEGHT	DEPTH
MODEL	mm	mm	mm
AEPF-305X305X75	305	305	75
AEPF-305X610X75	305	610	75
AEPF-508X610X75	508	610	75
AEPF-610X610X75	610	610	75
AEPF-305X305X100	305	305	100
AEPF-305X610X100	305	610	100
AEPF-508X610X100	508	610	100
AEPF-610X610X100	610	610	100





NOVVES

NOVVES ELEKTRİK MOTOR A.Ş.

Office: 19 Mayıs Mah. Sümer Sok. Zitaş Plaza C2 Blok No: 7 Kadıköy / İstanbul / Turkey
Factory: Taşköprü Merkez Mah. Çaydere Sok. Bina No: 9/1 No: 2 Çiftlikköy / Yalova / Turkey
Tel: +90 216 467 47 52 **E-mail:** info@novves.com

www.novves.com